

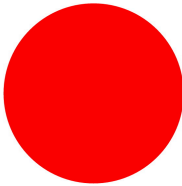

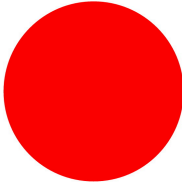

Illuminated pushbutton actuator, Flat, momentary, 1 NC, Screw connection, LED Red, red, Blank, 230 V AC, Bezel: titanium

Part no. C22-DL-R-K01-230
Catalog No. 136625
Alternate Catalog No. C22-DL-R-K01-230

Delivery program

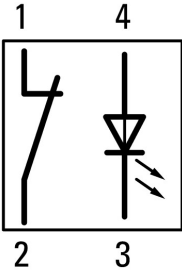
Product range			RMQ Compact
Basic function			Illuminated pushbutton actuators
Single unit/Complete unit			Complete unit
Design			Flat momentary
Connection type			Screw connection
Colour			
LED			
LED			Red
Button plate			
button plate			red
Button plate			
			Blank
Rated operational voltage LED			230 V AC
Name			None
Degree of Protection			IP66, IP67, IP69
Front ring			Bezel: titanium
Connection to SmartWire-DT			no
Contacts			
N/C = Normally closed			1 NC 
Notes			 = safety function, by positive opening to IEC/EN 60947-5-1
Actuator travel and actuation force as per DIN EN 60947-5-1, K.5.4.1			
	mm		4.65
Maximum travel	mm		5.7
Minimum force for positive opening	N		15
Contact sequence			

Contact travel = Contact closed = Contact open

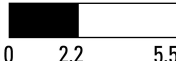
Contact diagram		
Positive opening (ZW)		yes

Technical data

General

Standards			IEC/EN 60947-5-1 VDE 0660
Lifespan, mechanical	Operations	x 10 ⁶	> 5
Operating frequency	Operations/h		≤ 3600
Actuating force		n	≤ 5
Climatic proofing			Damp heat, constant, to IEC 60068-2-78 Damp heat, cyclic, to IEC 60068-2-30
Degree of Protection			IP66, IP67, IP69
Ambient temperature			
Open		°C	-25 - +70
Storage		°C	- -30 - + 80
Mounting position			As required
Terminal capacities		mm ²	
Solid		mm ²	2 x 0.5 - 1.5_x
Flexible with ferrule		mm ²	2 x 0.5 - 1.5_x
Tightening torque for terminal screw		Nm	0.8

Contacts

Rated impulse withstand voltage	U _{imp}	V AC	4000
Rated insulation voltage	U _i	V	250
Rated conditional short-circuit current	I _q	kA	1
Overvoltage category/pollution degree			III/3
Control circuit reliability			
at 24 V DC/5 mA	H _F	Fault probability	values follow probability
at 5 V DC/1 mA	H _F	Fault probability	values follow probability
Max. short-circuit protective device			
Fuse	gG/gL	A	10

Design verification as per IEC/EN 61439

Technical data for design verification			
Operating ambient temperature min.		°C	-25
Operating ambient temperature max.		°C	70

Technical data ETIM 7.0

Low-voltage industrial components (EG000017) / Push button, complete (EC001028)			
Electric engineering, automation, process control engineering / Low-voltage switch technology / Command and alarm device / Push-button actuator, complete unit (ecl@ss10.0.1-27-37-12-28 [AKF046014])			
Number of command positions			1
Type of button			Flat
Colour button			Red
Construction type lens			Round
Hole diameter		mm	22.5
Width opening		mm	0
Height opening		mm	0
Suitable for illumination			Yes
Switching function latching			No
Spring-return			Yes

Supply voltage lamp	V	230
Number of contacts as normally open contact		0
Number of contacts as normally closed contact		1
Number of contacts as change-over contact		0
Type of electric connection		Screw connection
With front ring		Yes
Material front ring		Plastic
Colour front ring		Other
Degree of protection (IP)		Other
Degree of protection (NEMA)		

Approvals

Product Standards		IEC/EN 60947-5-1; UL 508; CAN/CSA-C22.2 No. 14-05 und 94-M91; CE marking
UL File No.		E29184
UL Category Control No.		NKCR
CSA File No.		165628
CSA Class No.		321103
North America Certification		UL listed, CSA certified
Degree of Protection		1,3R,4X,12,13

Dimensions

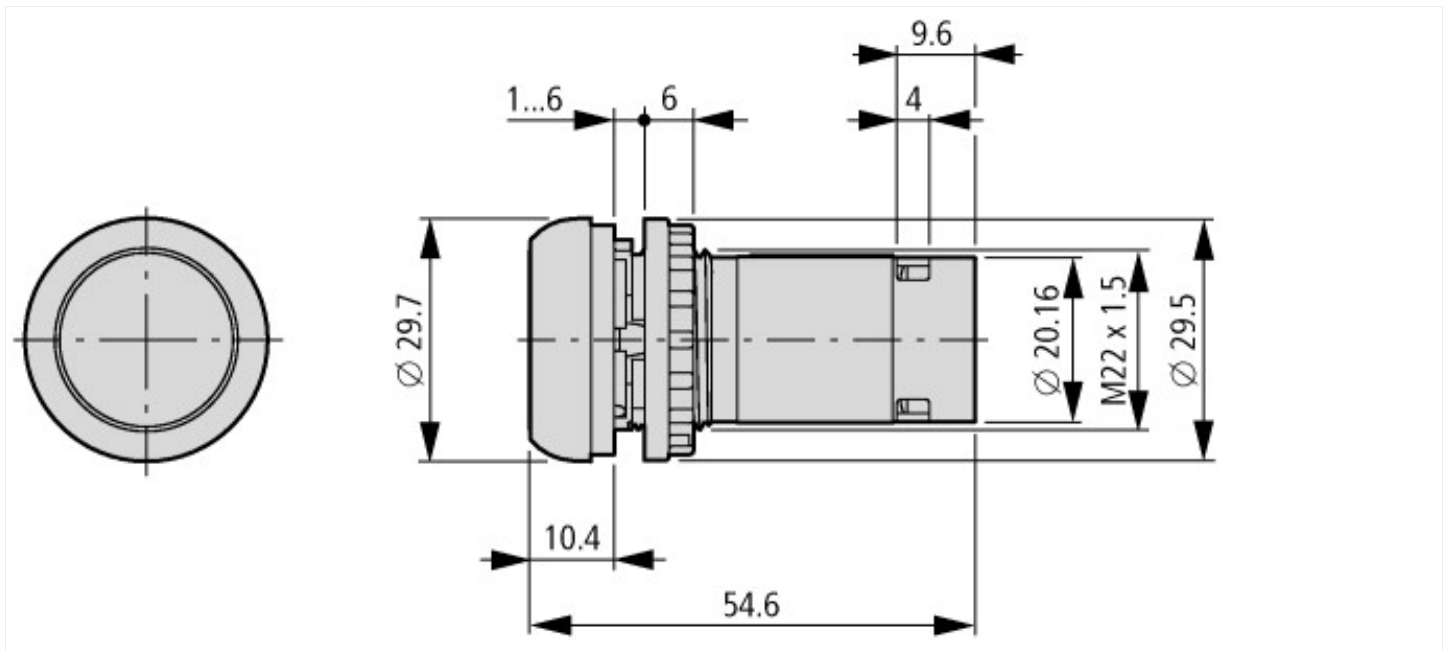

Additional product information (links)

IL04716025Z RMQ-Titan: compact programm

IL04716025Z RMQ-Titan: compact programm https://es-assets.eaton.com/DOCUMENTATION/AWA_INSTRUCTIONS/IL04716025Z2021_05.pdf