



Emergency-stop, Palm-tree shape, 60 mm, Key-release, MS8, 1 NC, 1 N/O, Screw connection, Not suitable for master key systems

Part no. C22-PVS60P-MS8-K11
Catalog No. 136606
Alternate Catalog No. C22-PVS60P-MS8-K11

Delivery program

Product range			RMQ Compact
Basic function			Controlled stop pushbuttons/emergency-stop buttons
Single unit/Complete unit			Complete unit
Design			Palm-tree shape
Diameter	∅	mm	60
Illumination			Non-illuminated
Approval			
Connection type			Key-release Screw connection
Description			Tamper-proof according to ISO 13850/EN 418 Not suitable for master key systems
Lock mechanism			MS8
Colour			
Mushroom head			Red
Base			yellow
Degree of Protection			IP66, IP67, IP69
Connection to SmartWire-DT			no
Contacts			
N/C = Normally closed			1 NC
N/O = Normally open			1 N/O
Notes			= safety function, by positive opening to IEC/EN 60947-5-1
Actuator travel and actuation force as per DIN EN 60947-5-1, K.5.4.1			
	mm		4.65
Maximum travel	mm		5.7
Minimum force for positive opening	N		20

Contact sequence		
Contact travel = Contact closed = Contact open		
Contact diagram		
Positive opening (ZW)		yes
Information about equipment supplied		1 key included as standard

Technical data

General

Standards			IEC/EN 60947-5-5 VDE 0660
Lifespan, mechanical	Operations	$\times 10^6$	> 0.05
Operating frequency	Operations/h		≤ 300
Actuating force	n		≤ 50
Climatic proofing			Damp heat, constant, to IEC 60068-2-78 Damp heat, cyclic, to IEC 60068-2-30
Degree of Protection			IP66, IP67, IP69
Mounting position			As required
Terminal capacities		mm ²	
Solid		mm ²	2 x 0.5 - 1.5
Flexible with ferrule		mm ²	2 x 0.5 - 1.5
Tightening torque for terminal screw		Nm	0.8

Contacts

Rated impulse withstand voltage	U_{imp}	V AC	4000
Rated insulation voltage	U_i	V	250
Rated conditional short-circuit current	I_q	kA	1
Overvoltage category/pollution degree			III/3
Control circuit reliability			
at 24 V DC/5 mA	H_F	Fault probability	values follow
at 5 V DC/1 mA	H_F	Fault probability	values follow
Max. short-circuit protective device			
Fuse	gG/gL	A	10

Technical data ETIM 7.0

Low-voltage industrial components (EG000017) / Emergency stop complete (EC002034)			
Electric engineering, automation, process control engineering / Low-voltage switch technology / Command and alarm device / EMERGENCY-STOP pushbutton, complete device (ecl@ss10.0.1-27-37-12-44 [ACN986011])			
Unlocking method			Key-release
Number of contacts as normally closed contact			1
Number of contacts as normally open contact			1
Degree of protection (IP)			Other
Mounting method			Built-in
With lighting			No

Hole diameter	mm	22.5
Connection type auxiliary circuit		Screw connection
Diameter cap	mm	60

Approvals

Product Standards		IEC/EN 60947-5-1; UL 508; CAN/CSA-C22.2 No. 14-05 und 94-M91; CE marking
UL File No.		E29184
UL Category Control No.		NKCR
CSA File No.		165628
CSA Class No.		321103
North America Certification		UL listed, CSA certified
Degree of Protection		1,3R,4X,12,13

Dimensions

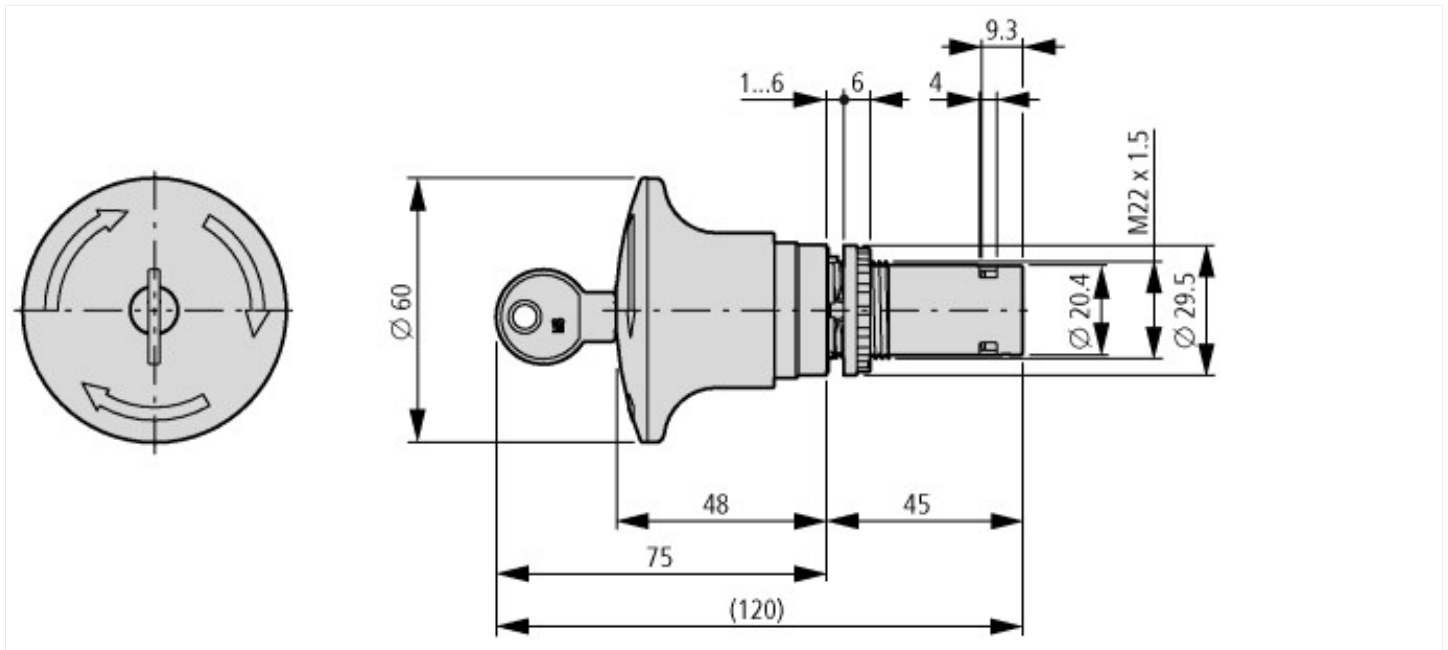

Additional product information (links)

DGUV Test Mark Customer Information

http://www.dguv.de/medien/dguv-test-medien/_pdf_zip_doc_ppt/agn-und-pzo/dguv_test_zeichen_infoblatt_kunden.pdf