



Diffuse reflective sensor,  $S_n=200\text{mm}$ , 4L, 10-30VDC, NPN, PNP, M18, insulated material, line 2m

**Part no.** 13106R6517  
**Catalog No.** 135623  
**Alternate Catalog No.** 13106R6517

## Delivery program

Basic function			Optical sensors
Product range			Comet Series
For connection of:			2 m connection cable
Design (outer dimensions)		mm	M18 x 1
Rated operational voltage	$U_e$		10 - 30 V DC
Rated switching distance	$S_n$	mm	200
Description			Beam: right-angled
Connection			4-wire
Function			Reflected-light beam
Type of light			Infra-red
Material			Insulated material
Switching type			NPN PNP
Switching principle			Adjustable bright/dark switching

### Information relevant for export to North America

Product Standards UL 508; CSA-C22.2 No. 14; IEC60947-5-2; CE marking

UL File No. E117028

UL Category Control No. NRKH, NRKH7

CSA File No. 50513

CSA Class No. 3211-07

North America Certification UL listed, CSA certified

Max. Voltage Rating 30 V DC

Degree of Protection IEC: IP68, IP69K; UL/CSA Type: 1, 4, 6

## Technical data

### General

Standards			IEC/EN 60947-5-2
Ambient temperature			-40 - +70
Mechanical shock resistance		g	100 Shock duration 3 ms
Degree of Protection			IP67

### Characteristics

Rated switching distance			
Rated switching distance	$S_n$	mm	200
Range		mm	0.2
Rated operational voltage	$U_e$		10 - 30 V DC
Operating current in the switched state at 24 V DC	$I_b$	mA	30
Maximum load current	$I_e$	mA	< PNP: 100 NPN: 250 (120 > 55 °C)
Response time		ms	1
Switching state display		LED	Red
Protective functions			Short-circuit protective device Protection against polarity reversal
Connection			4-wire
Style			
Design (outer dimensions)		mm	M18 x 1

For connection of:		2 m connection cable
Material		Insulated material

## Design verification as per IEC/EN 61439

Technical data for design verification		
Operating ambient temperature min.	°C	-40
Operating ambient temperature max.	°C	70

## Technical data ETIM 7.0

Sensors (EG000026) / Light scanner, energetic (EC001821)		
Electric engineering, automation, process control engineering / Binary sensor technology, safety-related sensor technology / Optoelectronic sensor / Light scanner, energetic (ec@ss10.0.1-27-09-03 [AKP252013])		
Operating distance	mm	0 - 0
Pre failure notice		No
With time function		No
Max. switching distance	mm	200
Max. output current	mA	250
Reflector included		No
Analogue output 0 V ... 10 V		No
Analogue output 0 mA ... 20 mA		No
Analogue output 4 mA ... 20 mA		No
Analogue output -10 V ... +10 V		No
With other analogue output		No
Setting procedure		Manual adjustment
With communication interface analogue		No
With communication interface AS-Interface		No
With communication interface CANOpen		No
With communication interface DeviceNet		No
With communication interface Ethernet		No
With communication interface INTERBUS		No
With communication interface PROFIBUS		No
With communication interface RS-232		No
With communication interface RS-422		No
With communication interface RS-485		No
With communication interface SSD		No
With communication interface SSI		No
Number of semiconductor outputs with signalling function		2
Number of contact energized outputs with signalling function		0
Number of protected semiconductor outputs		0
Number of protected contact energized outputs		0
Type of interface for safety communication		Other
Type of electric connection		Cable
Type of switching output		PNP/NPN
Type of switch function		Programmable/configurable
Operation agent-safety class		Safety class 2
Explosion safety category for gas		None
Explosion safety category for dust		None
Construction type housing		Cylinder, screw-thread
Width sensor	mm	0
Diameter sensor	mm	18
Height of sensor	mm	0
Length of sensor	mm	65
Sensing mode		Light-/dark switching
Material of optical surface		Plastic
Material housing		Plastic
Max. output current at protected output	mA	0

Min. reflector distance	mm	0
Time of reaction	ms	1
Transmission range of the safety field	m	0
Switching frequency	Hz	500
Type of safety acc. IEC 61496-1		
"Switching voltage of OSSD at state ""high""	V	0
Voltage type		DC
With monitoring function downstream switching devices		No
Laser protection class		None
Wavelength of the sensor	nm	0
Type of light		Infrared light
Light dot	mm <sup>2</sup>	0
AWG-number		22
Material of cable sheath		Polyvinyl chloride (PVC)
With restart blockage		No
Suitable for safety functions		No
Degree of protection (IP)		IP67
Degree of protection (NEMA)		6
Ambient temperature	°C	40 - 70
Rated control supply voltage Us at AC 50HZ	V	0 - 0
Rated control supply voltage Us at AC 60HZ	V	0 - 0
Rated control supply voltage Us at DC	V	10 - 30

## Approvals

Product Standards		UL 508; CSA-C22.2 No. 14; IEC60947-5-2; CE marking
UL File No.		E117028
UL Category Control No.		NRKH, NRKH7
CSA File No.		50513
CSA Class No.		3211-07
North America Certification		UL listed, CSA certified
Max. Voltage Rating		30 V DC
Degree of Protection		IEC: IP68, IP69K; UL/CSA Type: 1, 4, 6

## Dimensions

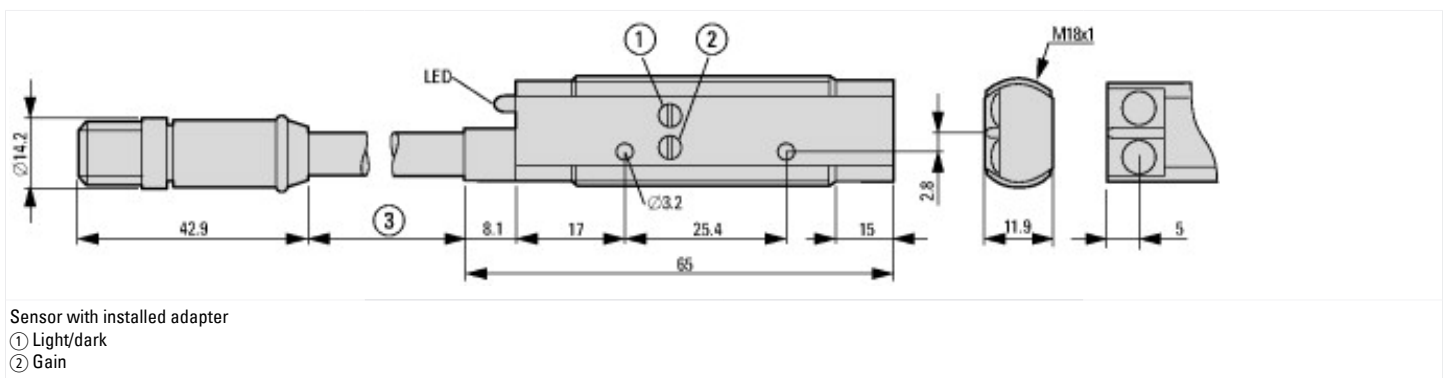

## Assets (links)

### Declaration of CE Conformity

00002430

### Instruction Leaflets

IL05305002Z2018\_05

## Additional product information (links)

### IL05305002Z Comet Series Optical Sensors

IL05305002Z Comet Series Optical Sensors [ftp://ftp.moeller.net/DOCUMENTATION/AWA\\_INSTRUCTIONS/IL05305002Z2018\\_05.pdf](ftp://ftp.moeller.net/DOCUMENTATION/AWA_INSTRUCTIONS/IL05305002Z2018_05.pdf)