



Indicator light, Extended, Screw connection, Lens Red, LED Red, 120 V AC



Powering Business Worldwide™

Part no. C22-LH-R-120
Catalog No. 121659
Alternate Catalog No. C22-LH-R-120

Delivery program

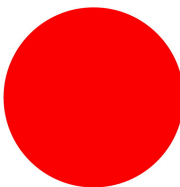
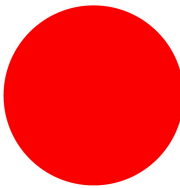
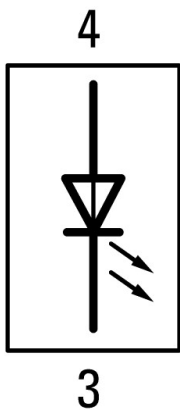
Product range			RMQ Compact
Basic function			Indicator lights
Single unit/Complete unit			Complete unit
Design			Extended
Connection type			Screw connection
Colour			
Lens			Red
Lens			
LED			
LED			Red
Rated operational voltage LED			120 V AC
Degree of Protection			IP66, IP67, IP69
Connection to SmartWire-DT			no
Contact sequence			

Technical data

General			
Standards			IEC/EN 60947-5-1 VDE 0660
Climatic proofing			Damp heat, constant, to IEC 60068-2-78 Damp heat, cyclic, to IEC 60068-2-30
Degree of Protection			IP66, IP67, IP69
Ambient temperature			
Open		°C	-25 - +70
Storage		°C	- -30 - + 80
Mounting position			As required

Terminal capacities		mm ²	
Solid		mm ²	2 x 0.5 - 1.5_x
Flexible with ferrule		mm ²	2 x 0.5 - 1.5_x
Tightening torque for terminal screw		Nm	0.8

Contacts

Rated impulse withstand voltage	U _{imp}	V AC	4000
Rated insulation voltage	U _i	V	250
Rated conditional short-circuit current	I _q	kA	1
Overvoltage category/pollution degree			III/3

Design verification as per IEC/EN 61439

Technical data for design verification			
Operating ambient temperature min.		°C	-25
Operating ambient temperature max.		°C	70

Technical data ETIM 7.0

Low-voltage industrial components (EG000017) / Indicator light complete (EC000272)			
Electric engineering, automation, process control engineering / Low-voltage switch technology / Command and alarm device / Indicator light complete (ecl@ss10.0.1-27-37-12-23 [AKF041014])			
Number of indicator lights			1
Colour lens			Red
Type of lamp socket			LED
With light source			Yes
Rated operating voltage U _e		V	120 - 120
Voltage type			AC
Type of electric connection			Screw connection
Construction type lens			Round
Type of lens			High
Hole diameter		mm	22.5
Width opening		mm	0
Height opening		mm	0
With front ring			Yes
Material front ring			Plastic
Colour front ring			Other
Degree of protection (IP)			Other
Degree of protection (NEMA)			

Approvals

Product Standards			IEC/EN 60947-5-1; UL 508; CAN/CSA-C22.2 No. 14-05 und 94-M91; CE marking
UL File No.			E29184
UL Category Control No.			NKCR
CSA File No.			165628
CSA Class No.			321103
North America Certification			UL listed, CSA certified
Degree of Protection			1,3R,4X,12,13

Dimensions

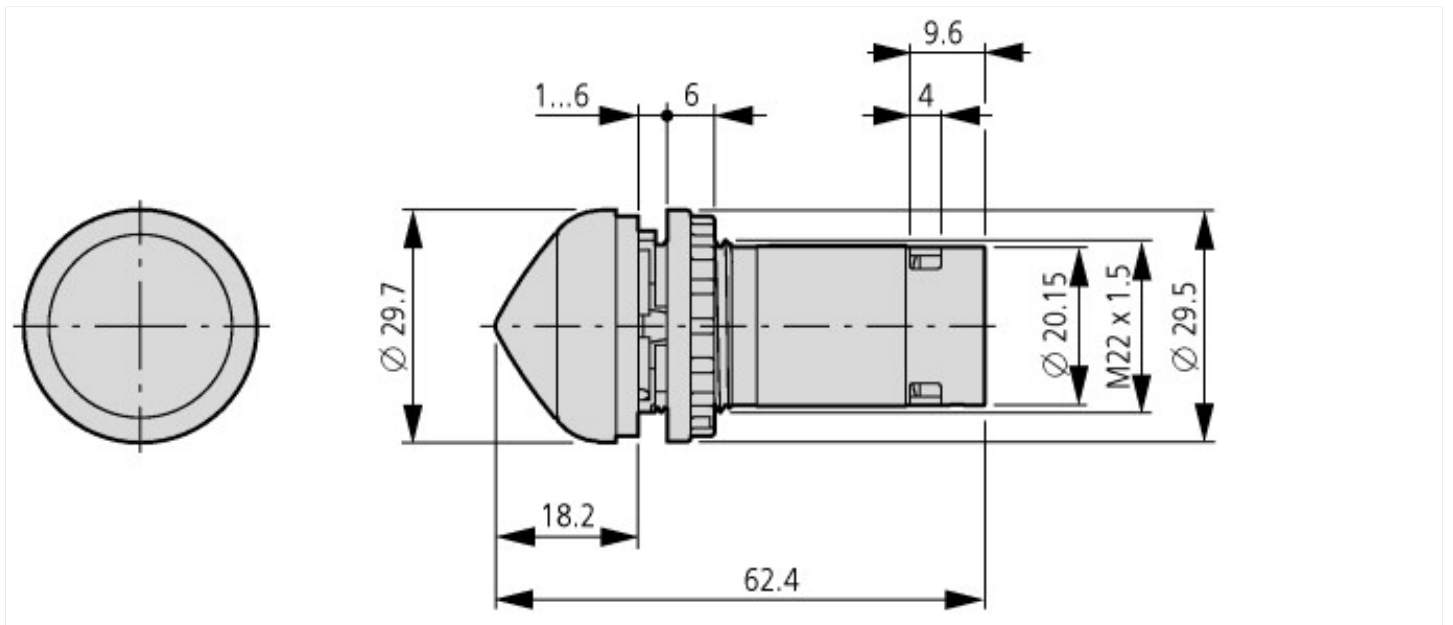

Additional product information (links)

IL04716025Z RMQ-Titan: compact programm

IL04716025Z RMQ-Titan: compact programm https://es-assets.eaton.com/DOCUMENTATION/AWA_INSTRUCTIONS/IL04716025Z2021_05.pdf