



Switch-disconnector, 4 p, 100A, frame size 1

Part no. LN1-4-100-I
Catalog No. 111999

Similar to illustration

Delivery program

Product range			Switch-disconnectors
Protective function			Disconnectors/main switches
Standard/Approval			IEC
Installation type			Fixed
Construction size			LN1
Description			Main switch characteristics including positive drive to IEC/EN 60204 and VDE 0113. Isolating characteristics to IEC/EN 60947-3 and VDE 0660. Busbar tag shroud to VDE 0160 Part 100.
Number of poles			4 pole
Standard equipment			Box terminal
Switch positions			I, +, 0
Rated current = rated uninterrupted current	$I_n = I_u$	A	100
Short-circuit protection max. fuse gL-characteristic		A gL	125

Technical data

Switch-disconnectors

Rated surge voltage invariability	U_{imp}		
Main contacts		V	6000
Auxiliary contacts		V	6000
Rated operational voltage	U_e	V AC	690
Rated operating frequency	f	Hz	50/60
Rated current = rated uninterrupted current	$I_n = I_u$	A	100
Overvoltage category/pollution degree			III/3
Rated insulation voltage	U_i	V	690
Use in unearthed supply systems		V	≤ 690

Rated short-circuit making capacity

690 V 50/60 H	I_c	kA	2.8
---------------	-------	----	-----

Rated short-time withstand current

t = 0.3 s	I_{cw}	kA	2
t = 1 s	I_{cw}	kA	2

Rated conditional short-circuit current

With back-up fuse		A gG/gL	PN1(N1)-63...125: 125 PN1(N1)-160: 160
400 ... 415 V		kA	100
690 V		kA	80
With downstream fuse		A gG/gL	PN1(N1)-63...125: 125 PN1(N1)-160: 160
400 ... 415 V		kA	100
690 V		kA	10

Rated making and breaking capacity

Rated operational current	I_e	A	
415 V	I_e	A	160
690 V	I_e	A	160
415 V	I_e	A	160
690 V	I_e	A	160
Lifespan, mechanical	Operations		20000
Max. operating frequency		Ops/h	120

Lifespan, electrical

400 V 50/60 Hz	Operations		10000
415 V 50/60 Hz	Operations		10000
690 V 50/60 Hz	Operations		7500
400 V 50/60 Hz	Operations		7500
415 V 50/60 Hz	Operations		7500
690 V 50/60 Hz	Operations		5000
Total break time at short-circuit		ms	< 10

Terminal capacity

Standard equipment			Box terminal
Round copper conductor			
Box terminal			
Solid		mm ²	1 x (10 - 16) 2 x (6 - 16)
Stranded		mm ²	1 x (25 - 70) Up to 95 mm ² can be connected depending on the cable manufacturer. 2 x 25
Tunnel terminal			
Solid		mm ²	1 x 16
Stranded			
Stranded		mm ²	1 x (25 - 95)
Bolt terminal and rear-side connection			
Direct on the switch			
Solid		mm ²	1 x (10 - 16) 2 x (6 - 16)
Stranded		mm ²	1 x (25 - 70) 2 x 25
Al conductors, Cu cable			
Tunnel terminal			
Solid		mm ²	1 x 16
Stranded			
Stranded		mm ²	1 x (25 - 95)
Cu strip (number of segments x width x segment thickness)			
Box terminal			
	min.	mm	2 x 9 x 0.8
	max.	mm	9 x 9 x 0.8
Copper busbar (width x thickness)		mm	
Bolt terminal and rear-side connection			
Screw connection			M6
Direct on the switch			
	min.	mm	12 x 5
	max.	mm	16 x 5
Control cables			
		mm ²	1 x (0.75 - 2.5) 2 x (0.75 - 1.5)

Design verification as per IEC/EN 61439

Technical data for design verification			
Rated operational current for specified heat dissipation	I _n	A	100
Equipment heat dissipation, current-dependent	P _{vid}	W	11.4
IEC/EN 61439 design verification			
10.2 Strength of materials and parts			
10.2.2 Corrosion resistance			Meets the product standard's requirements.
10.2.3.1 Verification of thermal stability of enclosures			Meets the product standard's requirements.
10.2.3.2 Verification of resistance of insulating materials to normal heat			Meets the product standard's requirements.
10.2.3.3 Verification of resistance of insulating materials to abnormal heat and fire due to internal electric effects			Meets the product standard's requirements.
10.2.4 Resistance to ultra-violet (UV) radiation			Meets the product standard's requirements.

10.2.5 Lifting		Does not apply, since the entire switchgear needs to be evaluated.
10.2.6 Mechanical impact		Does not apply, since the entire switchgear needs to be evaluated.
10.2.7 Inscriptions		Meets the product standard's requirements.
10.3 Degree of protection of ASSEMBLIES		Does not apply, since the entire switchgear needs to be evaluated.
10.4 Clearances and creepage distances		Meets the product standard's requirements.
10.5 Protection against electric shock		Does not apply, since the entire switchgear needs to be evaluated.
10.6 Incorporation of switching devices and components		Does not apply, since the entire switchgear needs to be evaluated.
10.7 Internal electrical circuits and connections		Is the panel builder's responsibility.
10.8 Connections for external conductors		Is the panel builder's responsibility.
10.9 Insulation properties		
10.9.2 Power-frequency electric strength		Is the panel builder's responsibility.
10.9.3 Impulse withstand voltage		Is the panel builder's responsibility.
10.9.4 Testing of enclosures made of insulating material		Is the panel builder's responsibility.
10.10 Temperature rise		The panel builder is responsible for the temperature rise calculation. Eaton will provide heat dissipation data for the devices.
10.11 Short-circuit rating		Is the panel builder's responsibility. The specifications for the switchgear must be observed.
10.12 Electromagnetic compatibility		Is the panel builder's responsibility. The specifications for the switchgear must be observed.
10.13 Mechanical function		The device meets the requirements, provided the information in the instruction leaflet (IL) is observed.

Technical data ETIM 7.0

Low-voltage industrial components (EG000017) / Switch disconnecter (EC000216)

Electric engineering, automation, process control engineering / Low-voltage switch technology / Off-load switch, circuit breaker, control switch / Switch disconnecter (ecl@ss10.0.1-27-37-14-03 [AKF060013])

Version as main switch		Yes
Version as maintenance-/service switch		Yes
Version as safety switch		No
Version as emergency stop installation		Yes
Version as reversing switch		No
Number of switches		
Max. rated operation voltage Ue AC	V	400
Rated operating voltage	V	690 - 690
Rated permanent current Iu	A	100
Rated permanent current at AC-23, 400 V	A	
Rated permanent current at AC-21, 400 V	A	0
Rated operation power at AC-3, 400 V	kW	0
Rated short-time withstand current Icw	kA	2
Rated operation power at AC-23, 400 V	kW	55
Switching power at 400 V	kW	0
Conditioned rated short-circuit current Iq	kA	100
Number of poles		4
Number of auxiliary contacts as normally closed contact		0
Number of auxiliary contacts as normally open contact		0
Number of auxiliary contacts as change-over contact		0
Motor drive optional		Yes
Motor drive integrated		No
Voltage release optional		Yes
Device construction		Built-in device fixed built-in technique
Suitable for ground mounting		Yes
Suitable for front mounting 4-hole		No
Suitable for front mounting centre		No
Suitable for distribution board installation		Yes
Suitable for intermediate mounting		Yes
Colour control element		Grey
Type of control element		Rocker lever

Interlockable		Yes
Type of electrical connection of main circuit		Frame clamp
Degree of protection (IP), front side		IP20
Degree of protection (NEMA)		

Dimensions

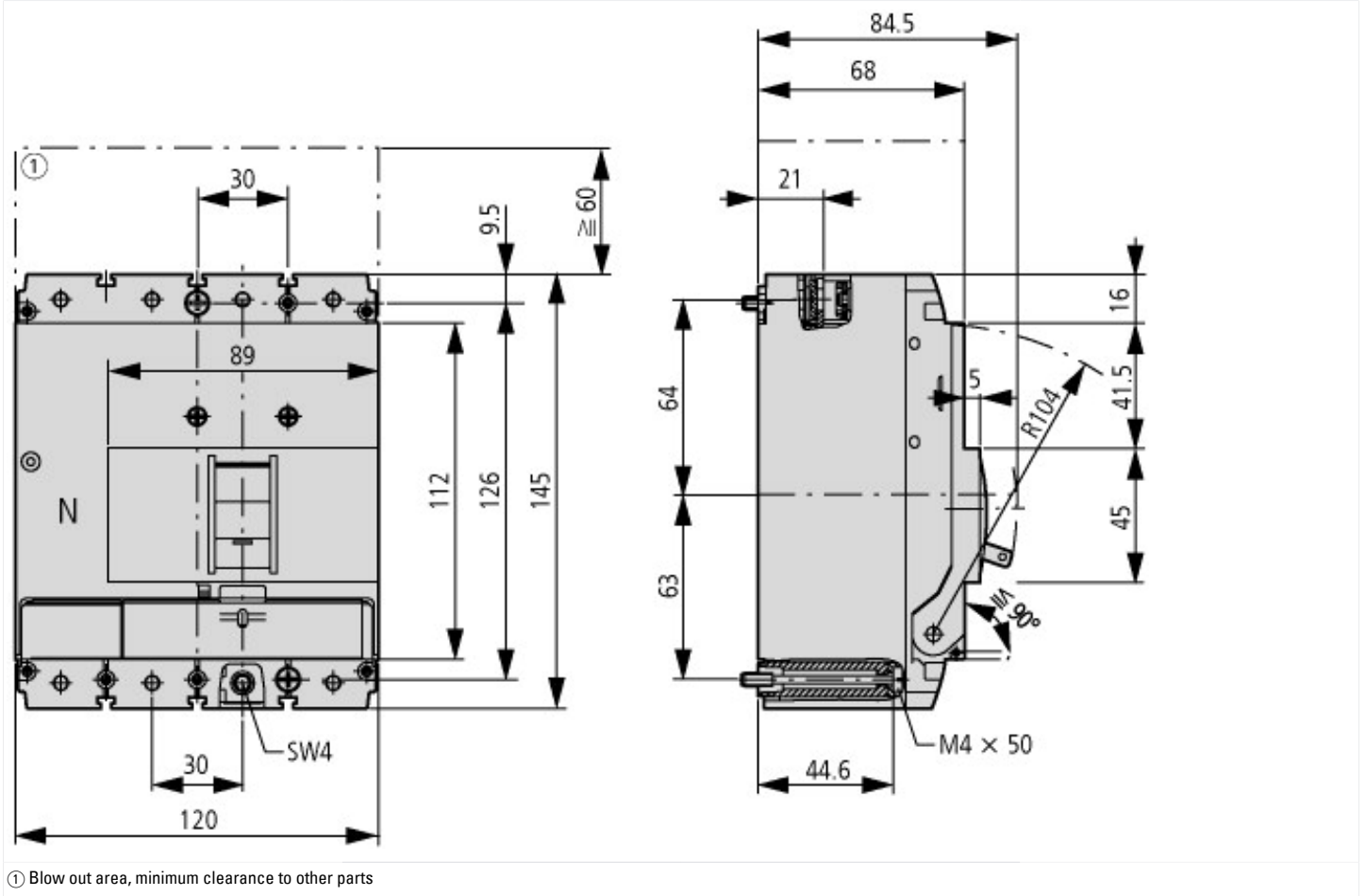

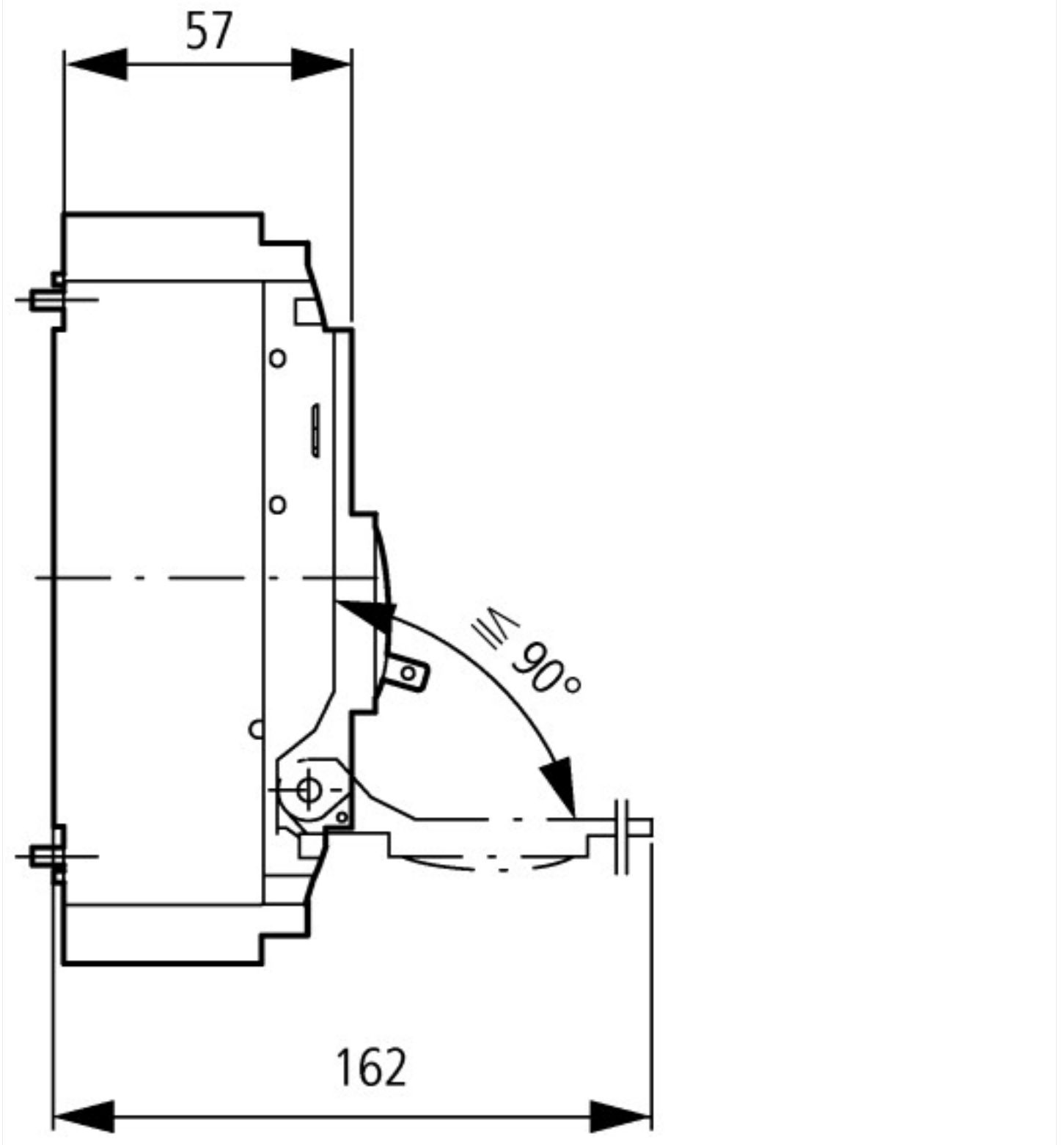

Additional product information (links)

IL01203007Z circuit-breaker LZM.1(-4), switch-disconnector LN1

IL01203007Z circuit-breaker LZM.1(-4), switch-disconnector LN1 ftp://ftp.moeller.net/DOCUMENTATION/AWA_INSTRUCTIONS/IL01203007Z2017_05.pdf