

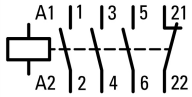

**Contactor, 380 V 50/60 Hz, 3 pole, 380 V 400 V, 4 kW, Contacts N/C = Normally closed= 1 NC, Screw terminals, AC operation**

**Part no. DILEM-01(380V50/60HZ)**  
**Catalog No. 033348**  
**Alternate Catalog No. XTMC9A01AR**

**Delivery program**

Product range			Contactors
Application			Mini Contactors for Motors and Resistive Loads
Subrange			DILEM contactors
Utilization category			AC-1: Non-inductive or slightly inductive loads, resistance furnaces NAC-3: Normal AC induction motors: starting, switch off during running AC-4: Normal AC induction motors: starting, plugging, reversing, inching
Notes			 Also suitable for motors with efficiency class IE3. IE3-ready devices are identified by the logo on their packaging.
Connection technique			Screw terminals
Description			With auxiliary contact
Number of poles			3 pole
<b>Rated operational current</b>			
AC-3			
380 V 400 V	$I_e$	A	9
AC-1			
Conventional free air thermal current, 3 pole, 50 - 60 Hz			
Open			
at 40 °C	$I_{th} = I_e$	A	22
<b>Max. rating for three-phase motors, 50 - 60 Hz</b>			
AC-3			
220 V 230 V	P	kW	2.2
380 V 400 V	P	kW	4
660 V 690 V	P	kW	4
AC-4			
220 V 230 V	P	kW	1.5
380 V 400 V	P	kW	3
660 V 690 V	P	kW	3
<b>Contacts</b>			
N/C = Normally closed			1 NC
Contact sequence			
For use with			...DILE
Actuating voltage			380 V 50/60 Hz
Voltage AC/DC			AC operation

**Technical data**

<b>General</b>			
Standards			IEC/EN 60947, VDE 0660, CSA, UL
Lifespan, mechanical; Coil 50/60 Hz	Operations	$\times 10^6$	7
Lifespan, mechanical	Operations	$\times 10^6$	10
Maximum operating frequency			
Mechanical		Ops./h	9000

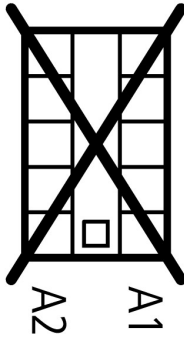
electrical (Contactors without overload relay)	Operations/h		See characteristic curves
Climatic proofing			Damp heat, constant, to IEC 60068-2-78 Damp heat, cyclic, to IEC 60068-2-30
Ambient temperature			
Open	°C		-25 - +50
Enclosed	°C		- 25 - 40
Storage	°C		
Min. ambient temperature, storage	°C		- 40
Ambient temperature, storage max.	°C		+ 80
Mounting position			As required, except vertical with terminals A1/A2 at the bottom
Mounting position			
Mechanical shock resistance (IEC/EN 60068-2-27)			
Half-sinusoidal shock, 10 ms			
Basic unit without auxiliary contact module			
Main contacts, make contacts	g		10
Main contacts Make/break contacts	g		
Break contact	g		10
Basic unit with auxiliary contact module			
Main contacts make contact	g		
Make	g		10
Auxiliary contacts Make/break contacts	g		20 / 20
Degree of Protection			IP20
Protection against direct contact when actuated from front (EN 50274)			Finger and back-of-hand proof
Altitude	m		Max. 2000
Weight	kg		0.17
Terminal capacity of auxiliary and main contacts			
Screw terminals			
Solid	mm <sup>2</sup>		1 x (0.75 - 2.5) 2 x (0.75 - 2.5)
Flexible with ferrule	mm <sup>2</sup>		1 x (0.75 - 1.5) 2 x (0.75 - 1.5)
Solid or stranded	AWG		18 - 14
Stripping length	mm		8
Terminal screw			M3.5
Pozidriv screwdriver	Size		2
Standard screwdriver	mm		0.8 x 5.5 1 x 6
Max. tightening torque	Nm		1.2
<b>Main conducting paths</b>			
Rated impulse withstand voltage	U <sub>imp</sub>	V AC	6000
Overvoltage category/pollution degree			III/3
Rated insulation voltage	U <sub>i</sub>	V AC	690
Rated operational voltage	U <sub>e</sub>	V AC	690
Safe isolation to EN 61140			
between coil and contacts		V AC	300
between the contacts		V AC	300
Making capacity (cos φ to IEC/EN 60947)		A	110
Breaking capacity			

220 V 230 V		A	90
380 V 400 V		A	90
500 V		A	64
660 V 690 V		A	42
Short-circuit protection maximum fuse			
Type "2", 500 V	gL/gG	A	10
Type "1", 500 V	gL/gG	A	20

## AC

AC-1			
Rated operational current			
Conventional free air thermal current, 3 pole, 50 - 60 Hz			
Open			
at 40 °C	$I_{th} = I_e$	A	22
at 50 °C	$I_{th} = I_e$	A	20
enclosed	$I_{th}$	A	16
Notes			At maximum permissible ambient air temperature.
Conventional free air thermal current, 1 pole			
Notes			At maximum permissible ambient air temperature.
open	$I_{th}$	A	50
enclosed	$I_{th}$	A	40

AC-3			
Rated operational current			
Open, 3-pole: 50 – 60 Hz			
Notes			At maximum permissible ambient temperature (open.)
220 V 230 V	$I_e$	A	9
240 V	$I_e$	A	9
380 V 400 V	$I_e$	A	9
415 V	$I_e$	A	9
440V	$I_e$	A	9
500 V	$I_e$	A	6.4
660 V 690 V	$I_e$	A	4.8
Motor rating		P	kWh
220 V 230 V	P	kW	2.2
240V	P	kW	2.5
380 V 400 V	P	kW	4
415 V	P	kW	4.3
440 V	P	kW	4.6
500 V	P	kW	4
660 V 690 V	P	kW	4

AC-4			
Rated operational current			
Open, 3-pole: 50 – 60 Hz			
Notes			At maximum permissible ambient air temperature.
220 V 230 V	$I_e$	A	6.6
240 V	$I_e$	A	6.6
380 V 400 V	$I_e$	A	6.6
415 V	$I_e$	A	6.6
440 V	$I_e$	A	6.6
500 V	$I_e$	A	5
660 V 690 V	$I_e$	A	3.4
Motor rating		P	kWh
220 V 230 V	P	kW	1.5
240 V	P	kW	1.8
380 V 400 V	P	kW	3

415 V	P	kW	3.1
440 V	P	kW	3.3
500 V	P	kW	3
660 V 690 V	P	kW	3

## DC

Rated operational current open			
DC-1			
12 V	$I_e$	A	20
24 V	$I_e$	A	20
60 V	$I_e$	A	20
110 V	$I_e$	A	20
220 V	$I_e$	A	20
Current heat losses (3- or 4-pole)			
at $I_{th}$ , 50 °C		W	5.9
at $I_e$ to AC-3/400 V		W	1.2

## Magnet systems

Voltage tolerance			
AC operated			
Dual-frequency coil 50/60 Hz	Pick-up	$x U_c$	0.85 - 1.1
Power consumption			
AC operation			
Dual-frequency coil 50/60 Hz at 50 Hz	Pick-up	VA	30
Dual-frequency coil 50/60 Hz at 50 Hz	Pick-up	W	26
Dual-frequency coil 50/60 Hz at 50 Hz	Sealing	VA	5.4
Dual-frequency coil 50/60 Hz at 50 Hz	Sealing	W	1.8
Dual-frequency coil 50/60 Hz at 60 Hz	Pick-up	VA	29
Dual-frequency coil 50/60 Hz at 60 Hz	Pick-up	W	24
Dual-frequency coil 50/60 Hz at 60 Hz	Sealing	VA	3.9
Dual-frequency coil 50/60 Hz at 60 Hz	Sealing	W	1.8
Duty factor		% DF	100
Switching times at 100 % $U_c$			
Make contact		ms	
Closing delay		ms	
Closing delay min.		ms	14
Closing delay max.		ms	21
Opening delay		ms	
Opening delay min.		ms	8
Opening delay max.		ms	18
Closing delay with top mounting auxiliary contact		ms	45
Reversing contactors			
Changeover time at 110 % $U_c$			
Changeover time min.		ms	16
Changeover time max.		ms	21
Arcing time at 690 V AC		ms	12

## Auxiliary contacts

Positive operating contacts to EN 60947-5-1 appendix L, including auxiliary contact module			Yes
Rated impulse withstand voltage	$U_{imp}$	V AC	6000
Overvoltage category/pollution degree			III/3
Rated insulation voltage	$U_i$	V AC	690
Rated operational voltage	$U_e$	V AC	600
Safe isolation to EN 61140			
between coil and auxiliary contacts		V AC	300
between the auxiliary contacts		V AC	300
Rated operational current			

AC-15				
220 V 240 V	$I_e$	A		6
380 V 415 V	$I_e$	A		3
500 V	$I_e$	A		1.5
DC L/R $\leq$ 15 ms				
Contacts in series:		A		
1	24 V	A		2.5
2	60 V	A		2.5
3	100 V	A		1.5
3	220 V	A		0.5
Conv. thermal current	$I_{th}$	A		10
Control circuit reliability	Failure rate	$\lambda$		$<10^{-8}$ , < one failure at 100 million operations (at $U_e = 24$ V DC, $U_{min} = 17$ V, $I_{min} = 5.4$ mA)
Component lifespan at $U_e = 240$ V				
AC-15	Operations	$\times 10^6$		0.2
DC current				
L/R = 50 ms: 2 contacts in series at $I_e = 0.5$ A	Operations	$\times 10^6$		0.15
Notes				Switch-on and switch-off conditions based on DC-13, time constant as specified
Short-circuit rating without welding				
Maximum overcurrent protective device				
Short-circuit protection only				PKZM0-4
Short-circuit protection maximum fuse				
500 V		A gG/gL		6
500 V		A fast		10
Current heat loss at a load of $I_{th}$ per contact		W		1.1

### Rating data for approved types

Switching capacity				
Maximum motor rating				
Three-phase				
200 V 208 V		HP		2
230 V 240 V		HP		3
460 V 480 V		HP		5
575 V 600 V		HP		5
Single-phase				
115 V 120 V		HP		0.5
230 V 240 V		HP		1.5
General use		A		15
Auxiliary contacts				
Pilot Duty				
AC operated				A600
DC operated				P300
General Use				
AC		V		600
AC		A		10
DC		V		250
DC		A		0.5
Short Circuit Current Rating		SCCR		
Basic Rating				
SCCR		kA		5
max. Fuse		A		45

## Design verification as per IEC/EN 61439

Technical data for design verification			
Rated operational current for specified heat dissipation	$I_n$	A	9
Heat dissipation per pole, current-dependent	$P_{vid}$	W	0.4
Equipment heat dissipation, current-dependent	$P_{vid}$	W	1.2
Static heat dissipation, non-current-dependent	$P_{vs}$	W	1.8
Heat dissipation capacity	$P_{diss}$	W	0
Operating ambient temperature min.		°C	-25
Operating ambient temperature max.		°C	50
IEC/EN 61439 design verification			
10.2 Strength of materials and parts			
10.2.2 Corrosion resistance			
			Meets the product standard's requirements.
10.2.3.1 Verification of thermal stability of enclosures			
			Meets the product standard's requirements.
10.2.3.2 Verification of resistance of insulating materials to normal heat			
			Meets the product standard's requirements.
10.2.3.3 Verification of resistance of insulating materials to abnormal heat and fire due to internal electric effects			
			Meets the product standard's requirements.
10.2.4 Resistance to ultra-violet (UV) radiation			
			Meets the product standard's requirements.
10.2.5 Lifting			
			Does not apply, since the entire switchgear needs to be evaluated.
10.2.6 Mechanical impact			
			Does not apply, since the entire switchgear needs to be evaluated.
10.2.7 Inscriptions			
			Meets the product standard's requirements.
10.3 Degree of protection of ASSEMBLIES			
			Does not apply, since the entire switchgear needs to be evaluated.
10.4 Clearances and creepage distances			
			Meets the product standard's requirements.
10.5 Protection against electric shock			
			Does not apply, since the entire switchgear needs to be evaluated.
10.6 Incorporation of switching devices and components			
			Does not apply, since the entire switchgear needs to be evaluated.
10.7 Internal electrical circuits and connections			
			Is the panel builder's responsibility.
10.8 Connections for external conductors			
			Is the panel builder's responsibility.
10.9 Insulation properties			
10.9.2 Power-frequency electric strength			
			Is the panel builder's responsibility.
10.9.3 Impulse withstand voltage			
			Is the panel builder's responsibility.
10.9.4 Testing of enclosures made of insulating material			
			Is the panel builder's responsibility.
10.10 Temperature rise			
			The panel builder is responsible for the temperature rise calculation. Eaton will provide heat dissipation data for the devices.
10.11 Short-circuit rating			
			Is the panel builder's responsibility. The specifications for the switchgear must be observed.
10.12 Electromagnetic compatibility			
			Is the panel builder's responsibility. The specifications for the switchgear must be observed.
10.13 Mechanical function			
			The device meets the requirements, provided the information in the instruction leaflet (IL) is observed.

## Technical data ETIM 7.0

Low-voltage industrial components (EG000017) / Power contactor, AC switching (EC000066)			
Electric engineering, automation, process control engineering / Low-voltage switch technology / Contactor (LV) / Power contactor, AC switching (ecl@ss10.0.1-27-37-10-03 [AAB718015])			
Rated control supply voltage $U_s$ at AC 50HZ		V	380 - 380
Rated control supply voltage $U_s$ at AC 60HZ		V	380 - 380
Rated control supply voltage $U_s$ at DC		V	0 - 0
Voltage type for actuating			AC
Rated operation current $I_e$ at AC-1, 400 V		A	22
Rated operation current $I_e$ at AC-3, 400 V		A	9
Rated operation power at AC-3, 400 V		kW	4
Rated operation current $I_e$ at AC-4, 400 V		A	6.6
Rated operation power at AC-4, 400 V		kW	3
Rated operation power NEMA		kW	3.7
Modular version			No
Number of auxiliary contacts as normally open contact			0
Number of auxiliary contacts as normally closed contact			1
Type of electrical connection of main circuit			Screw connection
Number of normally closed contacts as main contact			0

## Approvals

Product Standards	IEC/EN 60947-4-1; UL 508; CSA-C22.2 No. 14-05; CE marking
UL File No.	E29096
UL Category Control No.	NLDX
CSA File No.	012528
CSA Class No.	3211-04
North America Certification	UL listed, CSA certified
Specially designed for North America	No

## Characteristics

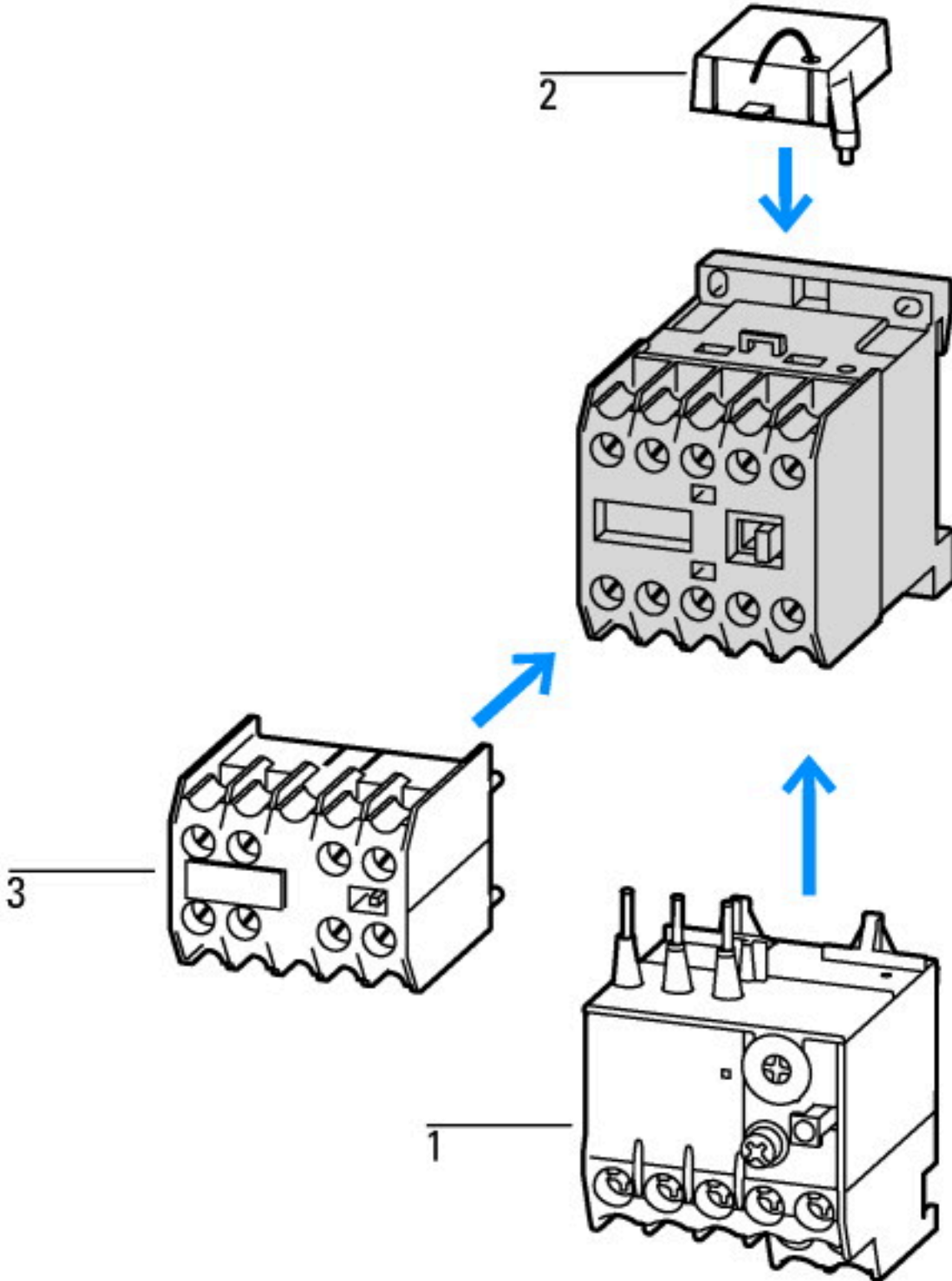

- 1: Overload relay
- 2: Suppressor
- 3: Auxiliary contact modules

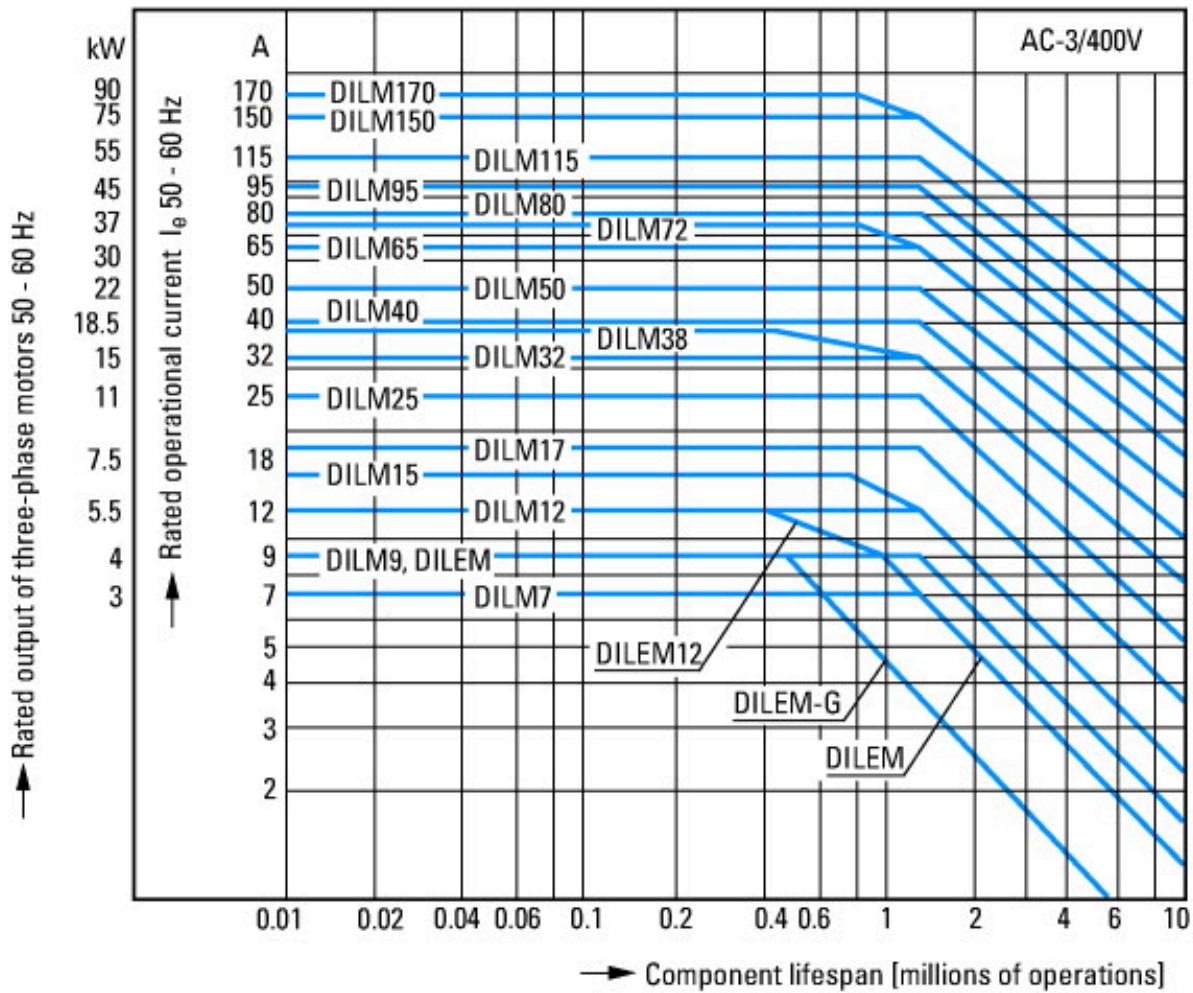

- Normal AC induction motor
- Operating characteristics
- Switch on: from stop
- Switch off: during run
- Electrical characteristics:
- Switch on: up to 6 x Rated motor current
- Switch off: up to 1 x Rated motor current
- Utility category
- 100 % AC-3
- Typical Applications
- Compressors
- Lifts
- Mixers
- Pumps
- Escalators
- Agitators
- fan
- Conveyor belts
- Centrifuges
- Hinged flaps
- Bucket-elevator
- Air-conditioning systems
- General drives for manufacturing and processing machines



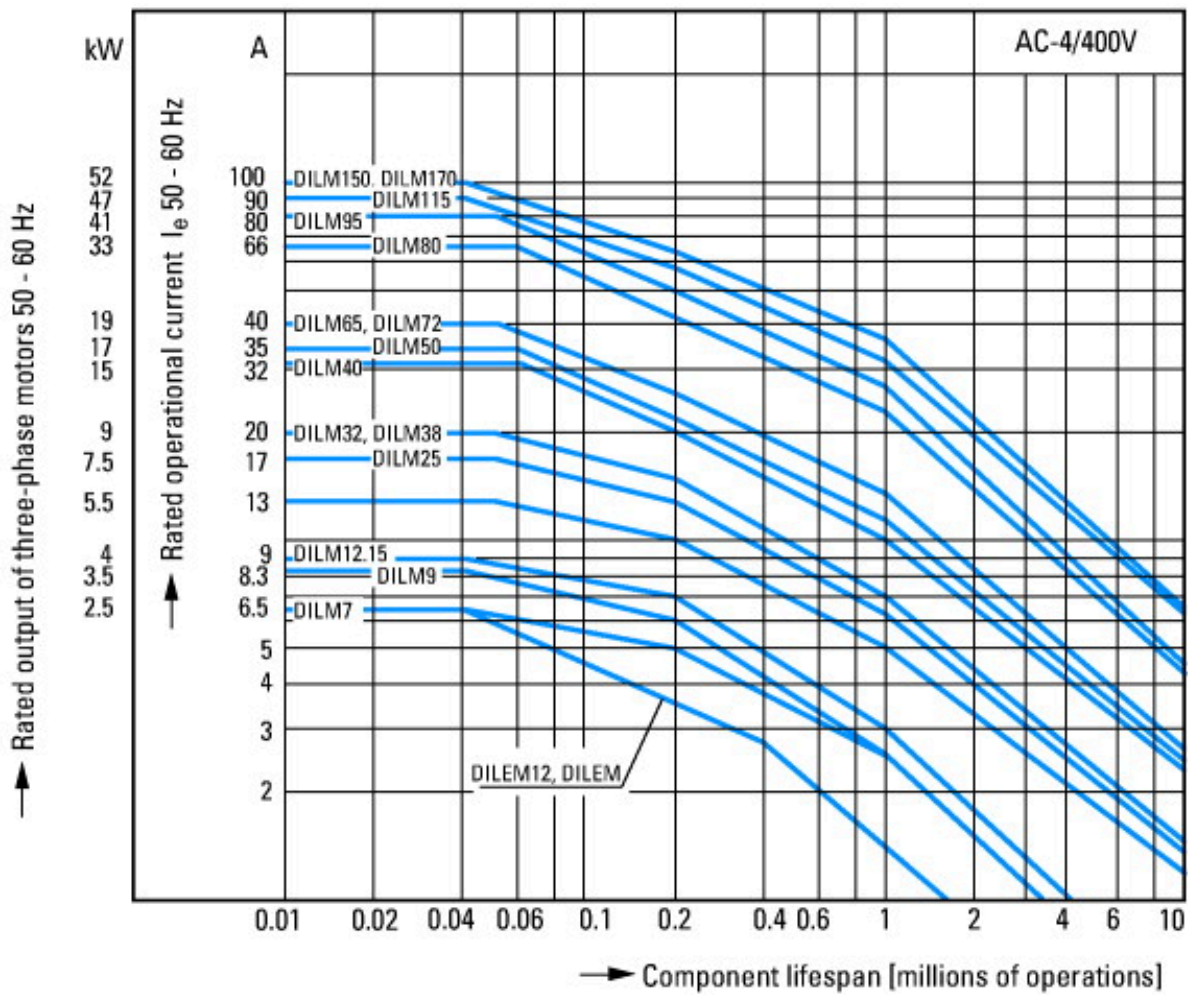

- Extreme switching duty
- Squirrel-cage motor
- Operating characteristics
- Inching, plugging, reversing
- Electrical characteristics
- Make: up to 6 x rated motor current
- Break: up to 6 x rated motor current
- Utilization category
- 100 % AC-4
- Typical applications
- Printing presses
- Wire-drawing machines
- Centrifuges
- Special drives for manufacturing and processing machines

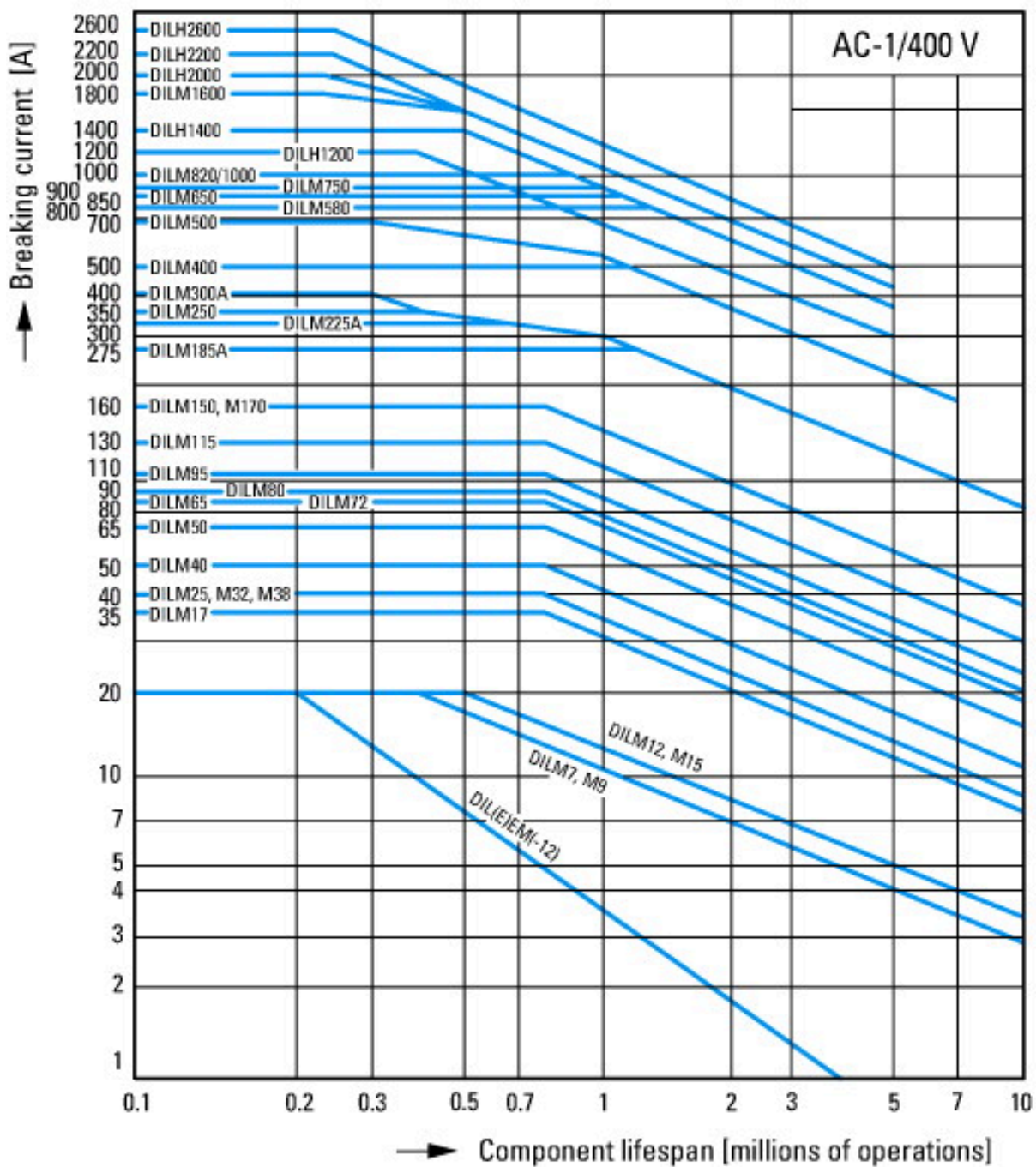

Switching duty for non-motor loads, 3-pole, 4-pole  
 Operating characteristics  
 Non-inductive or slightly inductive loads  
 Electrical characteristics  
 Make: 1 x rated current  
 Break: 1 x rated current  
 Utilization category  
 100 % AC-1  
 Typical applications  
 Electric heat



Short-time loading, 3-pole  
 Time interval between two loading cycles: 15 minutes

## Dimensions

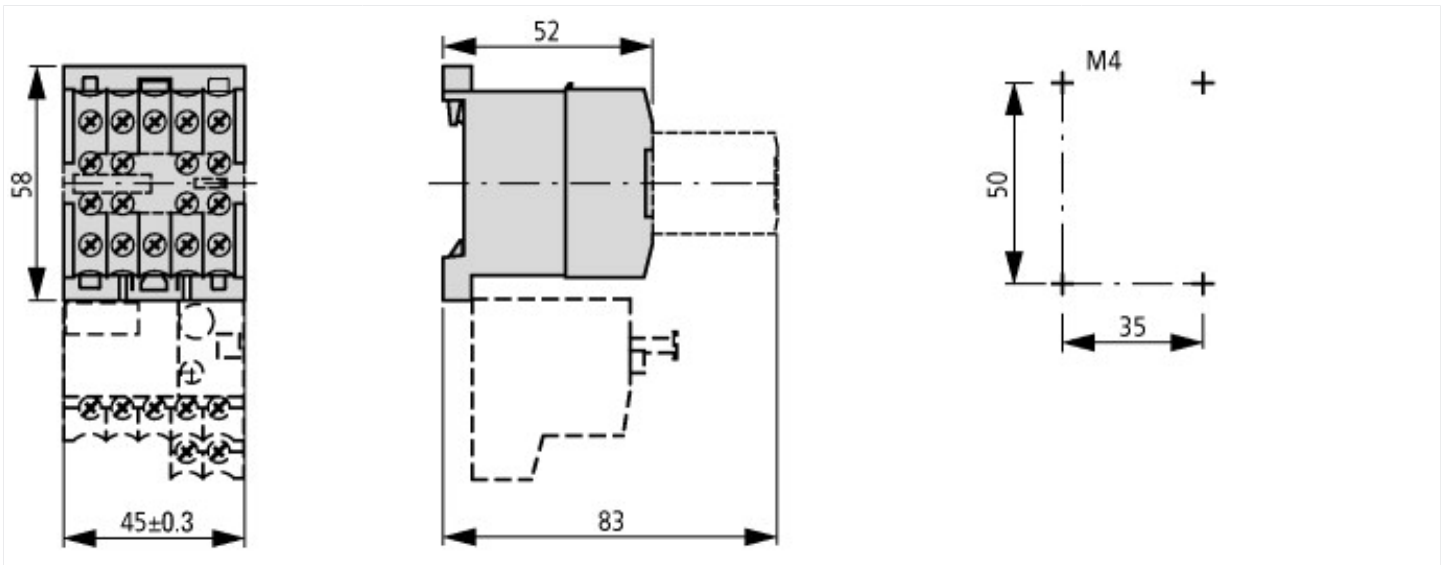

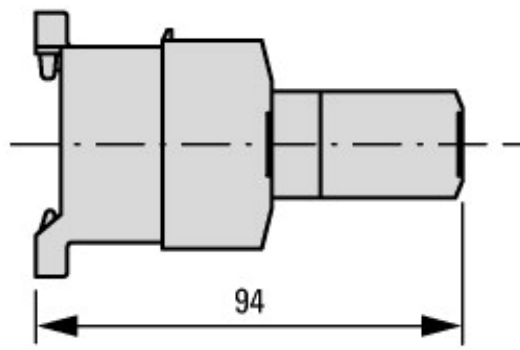
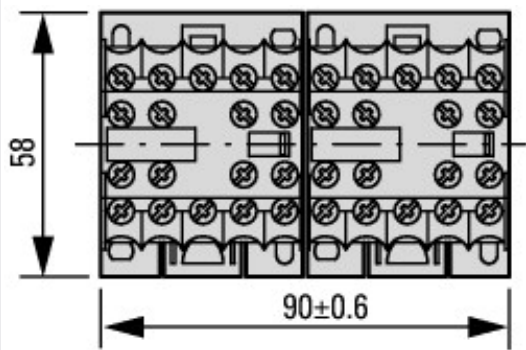

2DILE-... + MVDILE + ...DILE  
2DILE-...-G + MVDILE + ...DILE

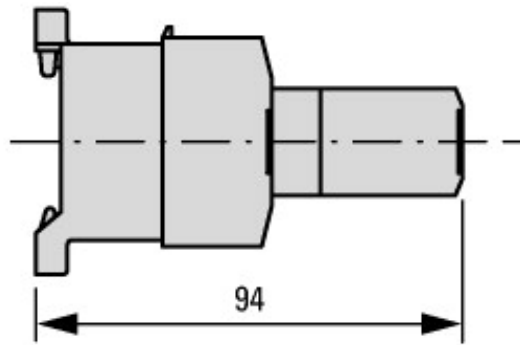
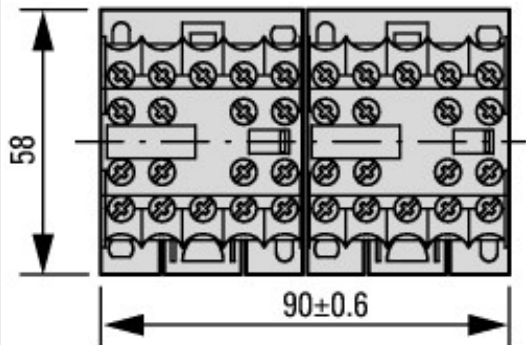

2DILE-... + MVDILE + ...DILE  
2DILE-...-G + MVDILE + ...DILE

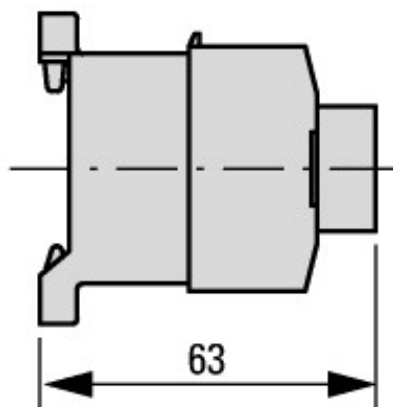
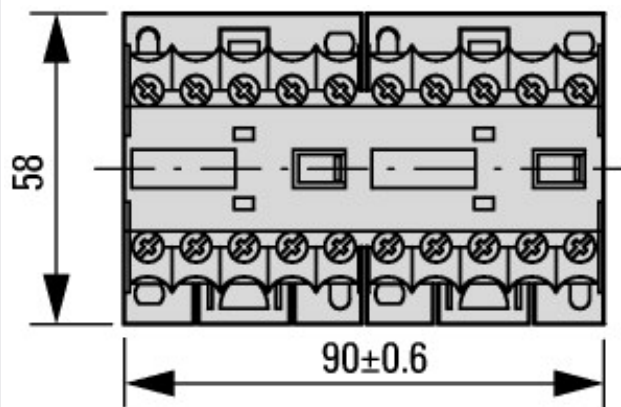

2DILE-... + MVDILE  
2DILE-...-G + MVDILE

## Assets (links)

### Declaration of CE Conformity

00003110

### Instruction Leaflets

IL03407009Z2018\_04

## Additional product information (links)

### IL03407009Z (AWA2100-0882) mini contactor relay

IL03407009Z (AWA2100-0882) mini contactor relay [ftp://ftp.moeller.net/DOCUMENTATION/AWA\\_INSTRUCTIONS/IL03407009Z2020\\_05.pdf](ftp://ftp.moeller.net/DOCUMENTATION/AWA_INSTRUCTIONS/IL03407009Z2020_05.pdf)