

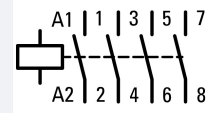

Contactor, 100 V 50Hz, 100-110 V 60Hz, 4 pole, 380 V 400 V, 4 kW, Screw terminals, AC operation

Part no. DILEM4(TVC100)
Catalog No. 000638
Alternate Catalog No. XTMF9A00E6

Delivery program

| | | | | |
|---|----------------|----|--|--|
| Product range | | | | Contactors |
| Application | | | | Mini Contactors for Motors and Resistive Loads |
| Subrange | | | | DILEM contactors |
| Utilization category | | | | AC-1: Non-inductive or slightly inductive loads, resistance furnaces NAC-3: Normal AC induction motors: starting, switch off during running AC-4: Normal AC induction motors: starting, plugging, reversing, inching |
| Connection technique | | | | Screw terminals |
| Number of poles | | | | 4 pole |
| Rated operational current | | | | |
| AC-3 | | | | |
| 380 V 400 V | I_e | A | | 9 |
| AC-1 | | | | |
| Conventional free air thermal current, 3 pole, 50 - 60 Hz | | | | |
| Open | | | | |
| at 40 °C | $I_{th} = I_e$ | A | | 22 |
| Max. rating for three-phase motors, 50 - 60 Hz | | | | |
| AC-3 | | | | |
| 220 V 230 V | P | kW | | 2.2 |
| 380 V 400 V | P | kW | | 4 |
| 660 V 690 V | P | kW | | 4 |
| AC-4 | | | | |
| 220 V 230 V | P | kW | | 1.5 |
| 380 V 400 V | P | kW | | 3 |
| 660 V 690 V | P | kW | | 3 |
| Contact sequence | | | |  |
| For use with | | | | ...DILE-C |
| Actuating voltage | | | | 100 V 50Hz, 100-110 V 60Hz |
| Voltage AC/DC | | | | AC operation |

Technical data

| | | | | |
|--|--------------|---------------|--|--|
| General | | | | |
| Standards | | | | IEC/EN 60947, VDE 0660, CSA, UL |
| Lifespan, mechanical; Coil 50/60 Hz | Operations | $\times 10^6$ | | 7 |
| Lifespan, mechanical | Operations | $\times 10^6$ | | 20 |
| Maximum operating frequency | | | | |
| Mechanical | | Ops./h | | 9000 |
| electrical (Contactors without overload relay) | Operations/h | | | Page 05/070 |
| Climatic proofing | | | | Damp heat, constant, to IEC 60068-2-78 Damp heat, cyclic, to IEC 60068-2-30 |
| Ambient temperature | | | | |
| Open | | °C | | -25 - +50 |
| Enclosed | | °C | | - 25 - 40 |
| Storage | | °C | | |

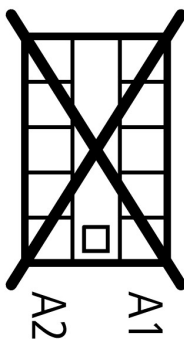
| | | |
|--|-----------------|--|
| Min. ambient temperature, storage | °C | - 40 |
| Ambient temperature, storage max. | °C | + 80 |
| Mounting position | | As required, except vertical with terminals A1/A2 at the bottom |
| Mounting position | |  |
| Mechanical shock resistance (IEC/EN 60068-2-27) | | |
| Half-sinusoidal shock, 10 ms | | |
| Basic unit without auxiliary contact module | | |
| Main contacts, make contacts | g | 10 |
| Basic unit with auxiliary contact module | | |
| Main contacts make contact | | |
| Make | g | 10 |
| Auxiliary contacts Make/break contacts | | |
| | g | 20 / 20 |
| Degree of Protection | | |
| IP20 | | |
| Protection against direct contact when actuated from front (EN 50274) | | |
| Finger and back-of-hand proof | | |
| Altitude | | |
| | m | Max. 2000 |
| Weight | | |
| | kg | 0.17 |
| Terminal capacity of auxiliary and main contacts | | |
| Screw terminals | | |
| Solid | | |
| | mm ² | 1 x (0.75 - 2.5) 2 x (0.75 - 2.5) |
| Flexible with ferrule | | |
| | mm ² | 1 x (0.75 - 1.5) 2 x (0.75 - 1.5) |
| Solid or stranded | | |
| | AWG | 18 - 14 |
| Stripping length | | |
| | mm | 8 |
| Terminal screw | | |
| | | M3.5 |
| Pozidriv screwdriver | | |
| | Size | 2 |
| Standard screwdriver | | |
| | mm | 0.8 x 5.5 1 x 6 |
| Max. tightening torque | | |
| | Nm | 1.2 |

Main conducting paths

| | | | |
|--|-----------|------|-------|
| Rated impulse withstand voltage | U_{imp} | V AC | 6000 |
| Overvoltage category/pollution degree | | | III/3 |
| Rated insulation voltage | U_i | V AC | 690 |
| Rated operational voltage | U_e | V AC | 690 |
| Safe isolation to EN 61140 | | | |
| between coil and contacts | | V AC | 300 |
| between the contacts | | V AC | 300 |
| Making capacity (cos φ to IEC/EN 60947) | | | |
| Breaking capacity | | | |
| 220 V 230 V | | A | 90 |
| 380 V 400 V | | A | 90 |
| 500 V | | A | 64 |
| 660 V 690 V | | A | 42 |
| Short-circuit protection maximum fuse | | | |
| Type "2", 500 V | gL/gG | A | 10 |
| Type "1", 500 V | gL/gG | A | 20 |

AC

| | | | |
|------|--|--|--|
| AC-1 | | | |
|------|--|--|--|

| | | | | |
|---|----------------|----|--|-----|
| Rated operational current | | | | |
| Conventional free air thermal current, 3 pole, 50 - 60 Hz | | | | |
| Open | | | | |
| at 40 °C | $I_{th} = I_e$ | A | 22 | |
| at 50 °C | $I_{th} = I_e$ | A | 20 | |
| at 55 °C | $I_{th} = I_e$ | A | 19 | |
| enclosed | I_{th} | A | 16 | |
| Notes | | | At maximum permissible ambient air temperature. | |
| Conventional free air thermal current, 1 pole | | | | |
| Notes | | | At maximum permissible ambient air temperature. | |
| open | I_{th} | A | 60 | |
| enclosed | I_{th} | A | 50 | |
| AC-3 | | | | |
| Rated operational current | | | | |
| Open, 3-pole: 50 – 60 Hz | | | | |
| Notes | | | At maximum permissible ambient temperature (open.) | |
| 220 V 230 V | I_e | A | 9 | |
| 240 V | I_e | A | 9 | |
| 380 V 400 V | I_e | A | 9 | |
| 415 V | I_e | A | 9 | |
| 440V | I_e | A | 9 | |
| 500 V | I_e | A | 6.4 | |
| 660 V 690 V | I_e | A | 4.8 | |
| Motor rating | | P | kWh | |
| 220 V 230 V | P | kW | | 2.2 |
| 240V | P | kW | | 2.5 |
| 380 V 400 V | P | kW | | 4 |
| 415 V | P | kW | | 4.3 |
| 440 V | P | kW | | 4.6 |
| 500 V | P | kW | | 4 |
| 660 V 690 V | P | kW | | 4 |
| AC-4 | | | | |
| Rated operational current | | | | |
| Open, 3-pole: 50 – 60 Hz | | | | |
| Notes | | | At maximum permissible ambient air temperature. | |
| 220 V 230 V | I_e | A | 6.6 | |
| 240 V | I_e | A | 6.6 | |
| 380 V 400 V | I_e | A | 6.6 | |
| 415 V | I_e | A | 6.6 | |
| 440 V | I_e | A | 6.6 | |
| 500 V | I_e | A | 5 | |
| 660 V 690 V | I_e | A | 3.4 | |
| Motor rating | | P | kWh | |
| 220 V 230 V | P | kW | | 1.5 |
| 240 V | P | kW | | 1.8 |
| 380 V 400 V | P | kW | | 3 |
| 415 V | P | kW | | 3.1 |
| 440 V | P | kW | | 3.3 |
| 500 V | P | kW | | 3 |
| 660 V 690 V | P | kW | | 3 |
| DC | | | | |
| Rated operational current open | | | | |
| DC-1 | | | | |
| 12 V | I_e | A | 20 | |

| | | | |
|------------------------------------|-------|---|-----|
| 24 V | I_e | A | 20 |
| 60 V | I_e | A | 20 |
| 110 V | I_e | A | 20 |
| 220 V | I_e | A | 20 |
| Current heat losses (3- or 4-pole) | | | |
| at I_{th} , 50 °C | | W | 7.9 |

Magnet systems

| | | | |
|--|---------|---------|------------|
| Voltage tolerance | | | |
| AC operated | | | |
| Single-voltage coil 50 Hz and dual-voltage coil 50 Hz, 60 Hz | Pick-up | $x U_c$ | 0.85 - 1.1 |
| Dual-frequency coil 50/60 Hz | Pick-up | $x U_c$ | |
| Voltage tolerance Dual-frequency coil 50/60 Hz, max. pick-up voltage | | $x U_c$ | 1.1 |
| Power consumption | | | |
| AC operation | | | |
| Single-voltage coil 50 Hz and dual-voltage coil 50 Hz, 60 Hz | Pick-up | VA | 25 |
| Single-voltage coil 50 Hz and dual-voltage coil 50 Hz, 60 Hz | Pick-up | W | 22 |
| Single-voltage coil 50 Hz and dual-voltage coil 50 Hz, 60 Hz | Sealing | VA | 4.6 |
| Single-voltage coil 50 Hz and dual-voltage coil 50 Hz, 60 Hz | Sealing | W | 1.8 |
| Duty factor | | % DF | 100 |
| Switching times at 100 % U_c | | | |
| Make contact | | ms | |
| Closing delay | | ms | |
| Closing delay min. | | ms | 14 |
| Closing delay max. | | ms | 21 |
| Opening delay | | ms | |
| Opening delay min. | | ms | 8 |
| Opening delay max. | | ms | 18 |
| Closing delay with top mounting auxiliary contact | | ms | 45 |
| Reversing contactors | | | |
| Changeover time at 110 % U_c | | | |
| Changeover time min. | | ms | 16 |
| Changeover time max. | | ms | 21 |
| Arcing time at 690 V AC | | ms | 12 |

Auxiliary contacts

| | | | |
|--|-----------|------|-------|
| Positive operating contacts to EN 60947-5-1 appendix L, including auxiliary contact module | | | Yes |
| Rated impulse withstand voltage | U_{imp} | V AC | 6000 |
| Overvoltage category/pollution degree | | | III/3 |
| Rated insulation voltage | U_i | V AC | 690 |
| Rated operational voltage | U_e | V AC | 600 |
| Safe isolation to EN 61140 | | | |
| between coil and auxiliary contacts | | V AC | 300 |
| between the auxiliary contacts | | V AC | 300 |
| Rated operational current | | | |
| AC-15 | | | |
| 220 V 240 V | I_e | A | 6 |
| 380 V 415 V | I_e | A | 3 |
| 500 V | I_e | A | 1.5 |
| DC L/R \leq 15 ms | | | |
| Contacts in series: | | A | |
| 1 | 24 V | A | 2.5 |
| 2 | 60 V | A | 2.5 |
| 3 | 100 V | A | 1.5 |
| 3 | 220 V | A | 0.5 |
| Conv. thermal current | I_{th} | A | 10 |

| | | | |
|---|--------------|---------------|--|
| Control circuit reliability | Failure rate | λ | $<10^{-8}$, < one failure at 100 million operations (at $U_e = 24$ V DC, $U_{min} = 17$ V, $I_{min} = 5.4$ mA) |
| Component lifespan at $U_e = 240$ V | | | |
| AC-15 | Operations | $\times 10^6$ | 0.2 |
| DC current | | | |
| L/R = 50 ms: 2 contacts in series at $I_e = 0.5$ A | Operations | $\times 10^6$ | 0.15 |
| Notes | | | Switch-on and switch-off conditions based on DC-13, time constant as specified |
| Short-circuit rating without welding | | | |
| Maximum overcurrent protective device | | | |
| Short-circuit protection only | | | PKZM0-4 |
| Short-circuit protection maximum fuse | | | |
| 500 V | | A gG/gL | 6 |
| 500 V | | A fast | 10 |
| Current heat loss at a load of I_{th} per contact | | W | 1.1 |

Rating data for approved types

| | | | |
|------------------------------|--|------|-----|
| Switching capacity | | | |
| Maximum motor rating | | | |
| Three-phase | | | |
| 200 V 208 V | | HP | 2 |
| 230 V 240 V | | HP | 3 |
| 460 V 480 V | | HP | 5 |
| 575 V 600 V | | HP | 5 |
| Single-phase | | | |
| 115 V 120 V | | HP | 0.5 |
| 230 V 240 V | | HP | 1.5 |
| General use | | A | 15 |
| Short Circuit Current Rating | | SCCR | |
| Basic Rating | | | |
| SCCR | | kA | 5 |
| max. Fuse | | A | 45 |

Design verification as per IEC/EN 61439

| | | | |
|--|------------|----|--|
| Technical data for design verification | | | |
| Rated operational current for specified heat dissipation | I_n | A | 22 |
| Heat dissipation per pole, current-dependent | P_{vid} | W | 2.39 |
| Equipment heat dissipation, current-dependent | P_{vid} | W | 9.56 |
| Static heat dissipation, non-current-dependent | P_{vs} | W | 1.8 |
| Heat dissipation capacity | P_{diss} | W | 0 |
| Operating ambient temperature min. | | °C | -25 |
| Operating ambient temperature max. | | °C | 50 |
| IEC/EN 61439 design verification | | | |
| 10.2 Strength of materials and parts | | | |
| 10.2.2 Corrosion resistance | | | Meets the product standard's requirements. |
| 10.2.3.1 Verification of thermal stability of enclosures | | | Meets the product standard's requirements. |
| 10.2.3.2 Verification of resistance of insulating materials to normal heat | | | Meets the product standard's requirements. |
| 10.2.3.3 Verification of resistance of insulating materials to abnormal heat and fire due to internal electric effects | | | Meets the product standard's requirements. |
| 10.2.4 Resistance to ultra-violet (UV) radiation | | | Meets the product standard's requirements. |
| 10.2.5 Lifting | | | Does not apply, since the entire switchgear needs to be evaluated. |
| 10.2.6 Mechanical impact | | | Does not apply, since the entire switchgear needs to be evaluated. |
| 10.2.7 Inscriptions | | | Meets the product standard's requirements. |
| 10.3 Degree of protection of ASSEMBLIES | | | Does not apply, since the entire switchgear needs to be evaluated. |

| | | |
|--|--|--|
| 10.4 Clearances and creepage distances | | Meets the product standard's requirements. |
| 10.5 Protection against electric shock | | Does not apply, since the entire switchgear needs to be evaluated. |
| 10.6 Incorporation of switching devices and components | | Does not apply, since the entire switchgear needs to be evaluated. |
| 10.7 Internal electrical circuits and connections | | Is the panel builder's responsibility. |
| 10.8 Connections for external conductors | | Is the panel builder's responsibility. |
| 10.9 Insulation properties | | |
| 10.9.2 Power-frequency electric strength | | Is the panel builder's responsibility. |
| 10.9.3 Impulse withstand voltage | | Is the panel builder's responsibility. |
| 10.9.4 Testing of enclosures made of insulating material | | Is the panel builder's responsibility. |
| 10.10 Temperature rise | | The panel builder is responsible for the temperature rise calculation. Eaton will provide heat dissipation data for the devices. |
| 10.11 Short-circuit rating | | Is the panel builder's responsibility. The specifications for the switchgear must be observed. |
| 10.12 Electromagnetic compatibility | | Is the panel builder's responsibility. The specifications for the switchgear must be observed. |
| 10.13 Mechanical function | | The device meets the requirements, provided the information in the instruction leaflet (IL) is observed. |

Technical data ETIM 7.0

| | | |
|---|----|------------------|
| Low-voltage industrial components (EG000017) / Power contactor, AC switching (EC000066) | | |
| Electric engineering, automation, process control engineering / Low-voltage switch technology / Contactor (LV) / Power contactor, AC switching (ecl@ss10.0.1-27-37-10-03 [AAB718015]) | | |
| Rated control supply voltage U_s at AC 50HZ | V | 100 - 100 |
| Rated control supply voltage U_s at AC 60HZ | V | 100 - 110 |
| Rated control supply voltage U_s at DC | V | 0 - 0 |
| Voltage type for actuating | | AC |
| Rated operation current I_e at AC-1, 400 V | A | 22 |
| Rated operation current I_e at AC-3, 400 V | A | 9 |
| Rated operation power at AC-3, 400 V | kW | 4 |
| Rated operation current I_e at AC-4, 400 V | A | 6.6 |
| Rated operation power at AC-4, 400 V | kW | 3 |
| Rated operation power NEMA | kW | 3.7 |
| Modular version | | No |
| Number of auxiliary contacts as normally open contact | | 0 |
| Number of auxiliary contacts as normally closed contact | | 0 |
| Type of electrical connection of main circuit | | Screw connection |
| Number of normally closed contacts as main contact | | 0 |
| Number of main contacts as normally open contact | | 4 |

Approvals

| | | |
|--------------------------------------|--|---|
| Product Standards | | IEC/EN 60947-4-1; UL 508; CSA-C22.2 No. 14-05; CE marking |
| UL File No. | | E29096 |
| UL Category Control No. | | NLDX |
| CSA File No. | | 012528 |
| CSA Class No. | | 3211-04 |
| North America Certification | | UL listed, CSA certified |
| Specially designed for North America | | No |

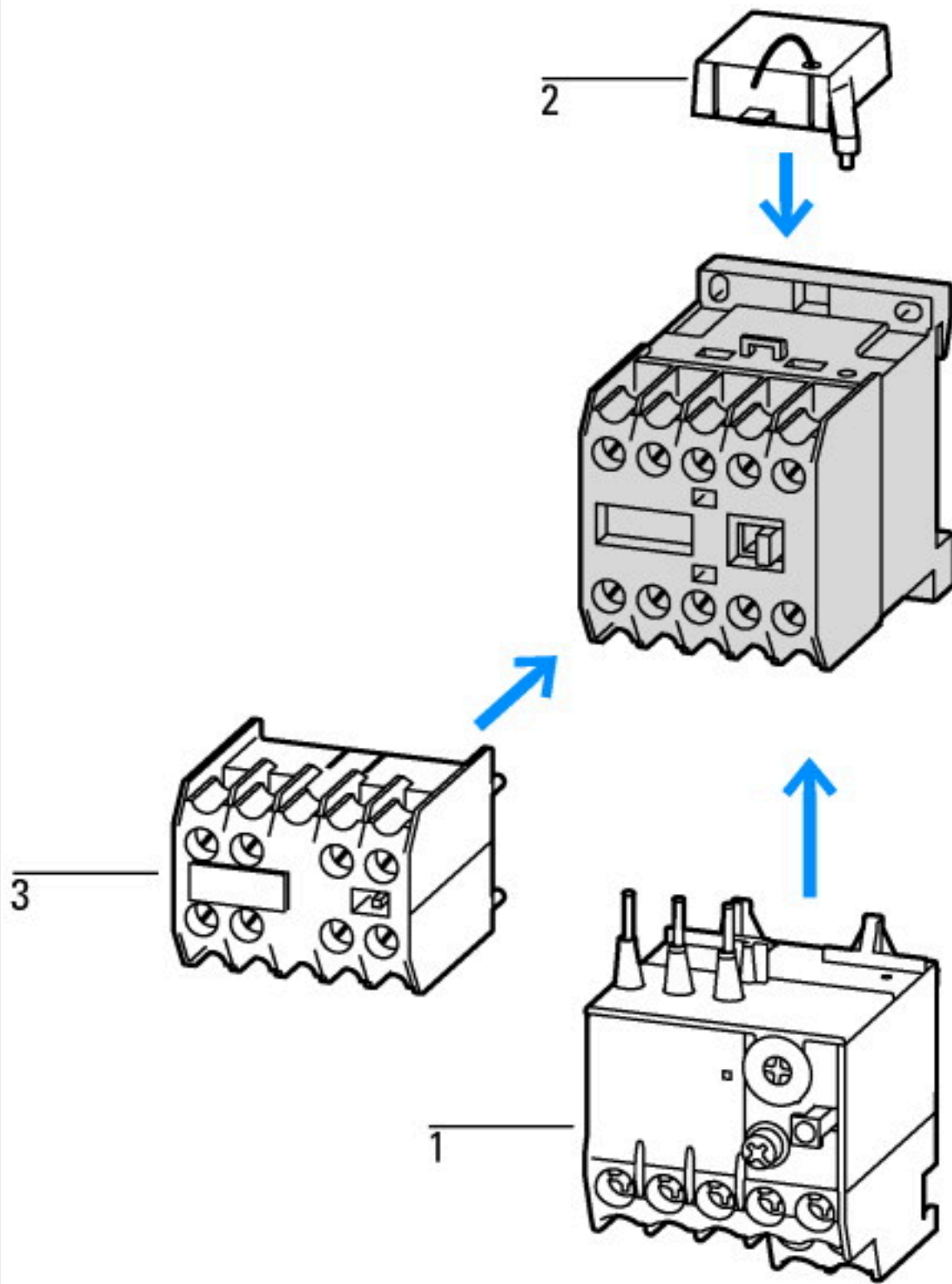

- 1: Overload relay
 - 2: Suppressor
 - 3: Auxiliary contact modules
- Enclosure totally insulated

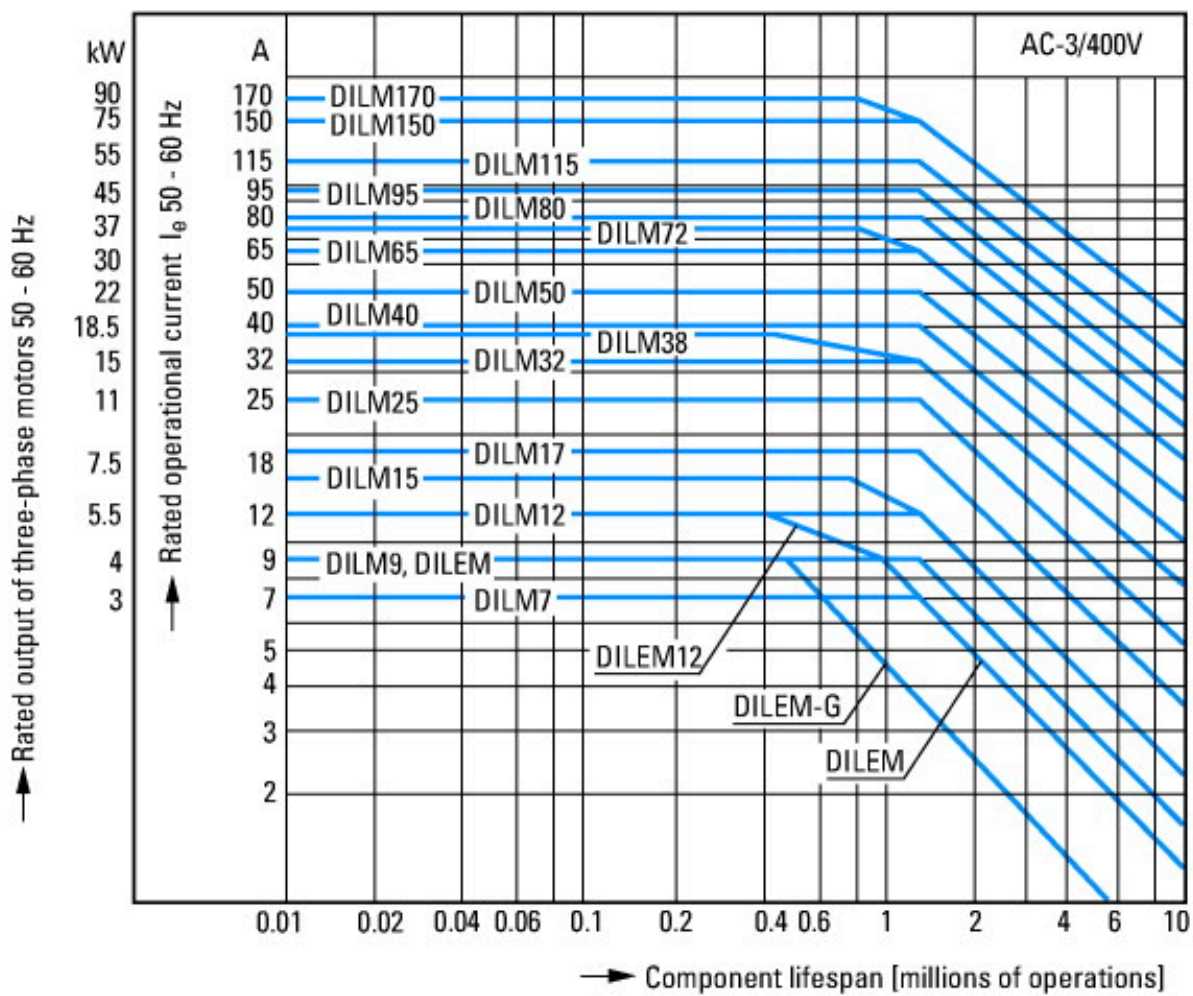

- Squirrel-cage motor
- Operating characteristics
- Starting: from rest
- Stopping: after attaining full running speed
- Electrical characteristics
- Make: up to 6 x rated motor current
- Break: up to 1 x rated motor current
- Utilization category
- 100 % AC-3
- Typical applications
- Compressors
- Lifts
- Mixers
- Pumps
- Escalators
- Agitators
- Fans
- Conveyor belts
- Centrifuges
- Hinged flaps
- Bucket-elevators
- Air conditioning system
- General drives in manufacturing and processing machines

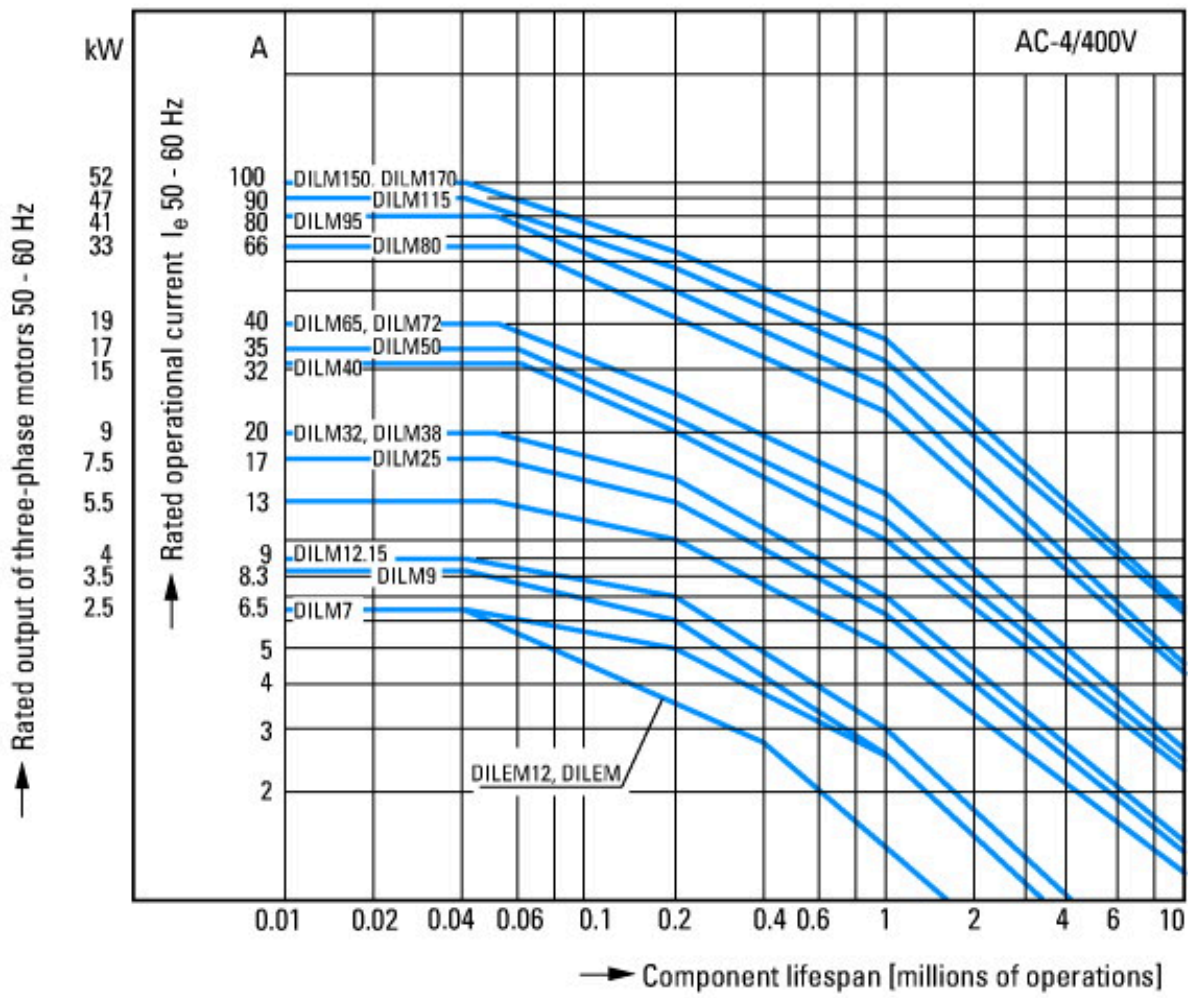

- Extreme switching duty
- Squirrel-cage motor
- Operating characteristics
- Inching, plugging, reversing
- Electrical characteristics
- Make: up to 6 x rated motor current
- Break: up to 6 x rated motor current
- Utilization category
- 100 % AC-4
- Typical applications
- Printing presses
- Wire-drawing machines
- Centrifuges
- Special drives for manufacturing and processing machines

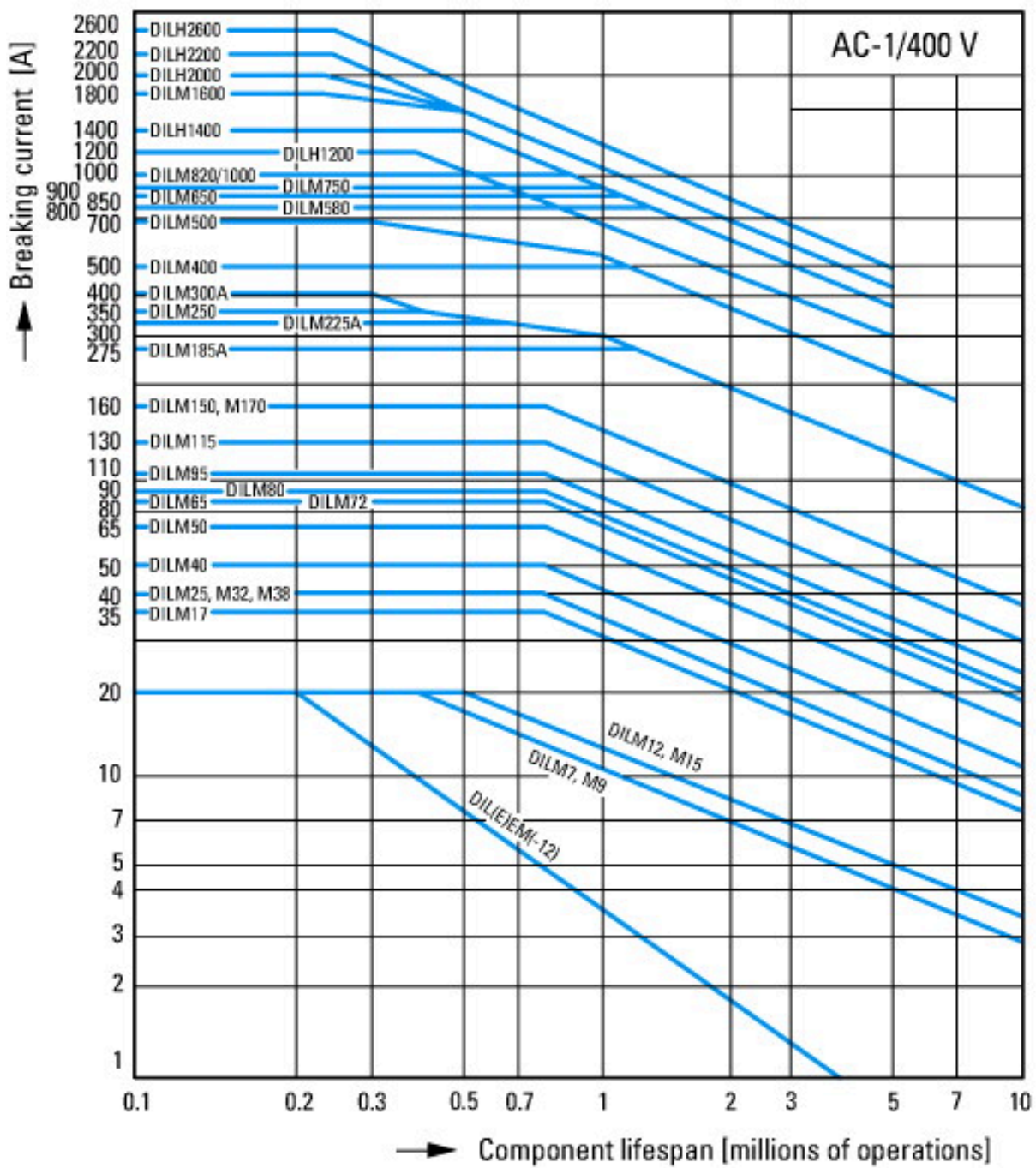

Switching duty for non-motor loads, 3-pole, 4-pole
 Operating characteristics
 Non-inductive or slightly inductive loads
 Electrical characteristics
 Make: 1 x rated current
 Break: 1 x rated current
 Utilization category
 100 % AC-1
 Typical applications
 Electric heat

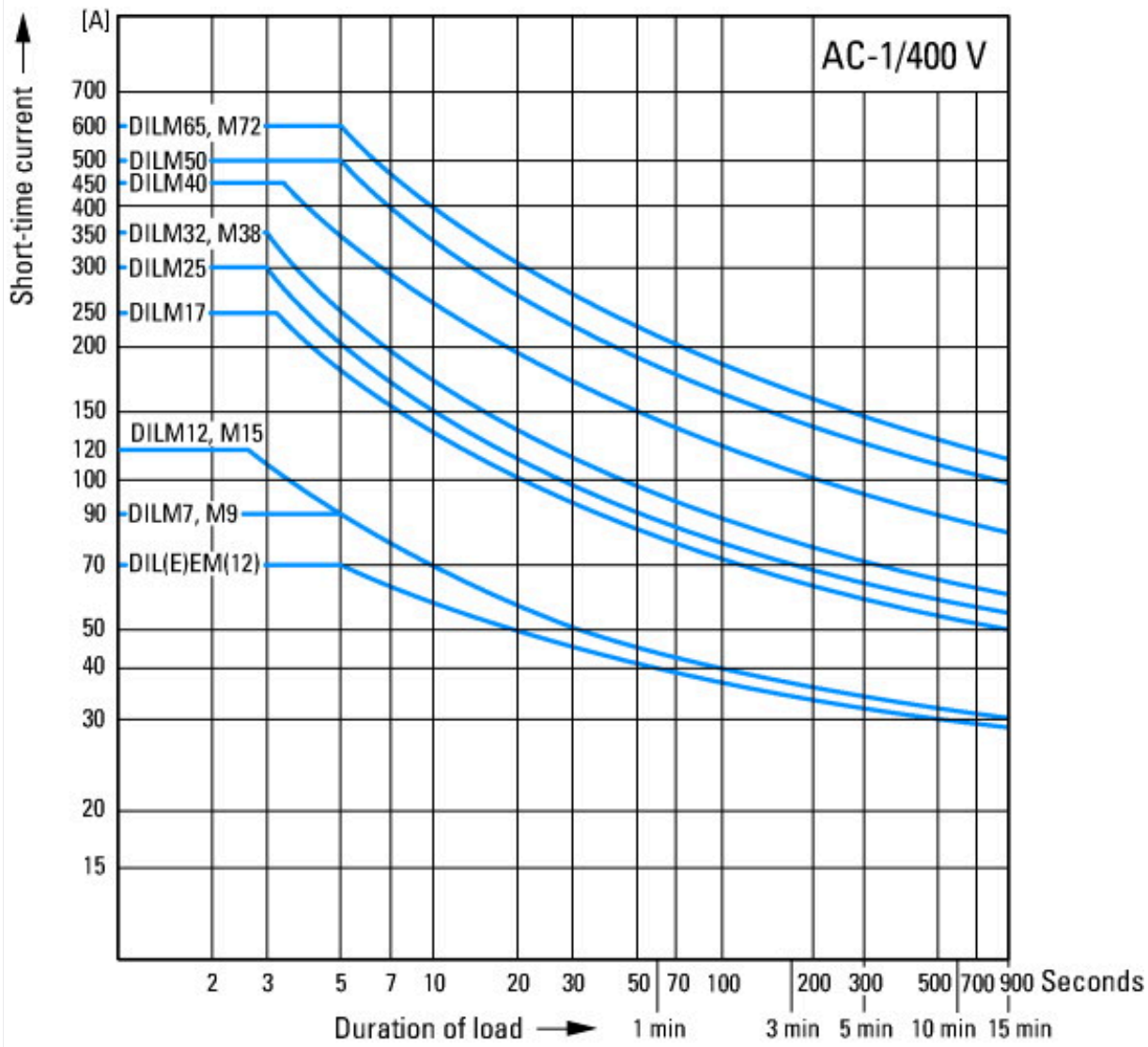

Short-time loading, 3-pole
 Time interval between two loading cycles: 15 minutes

Dimensions

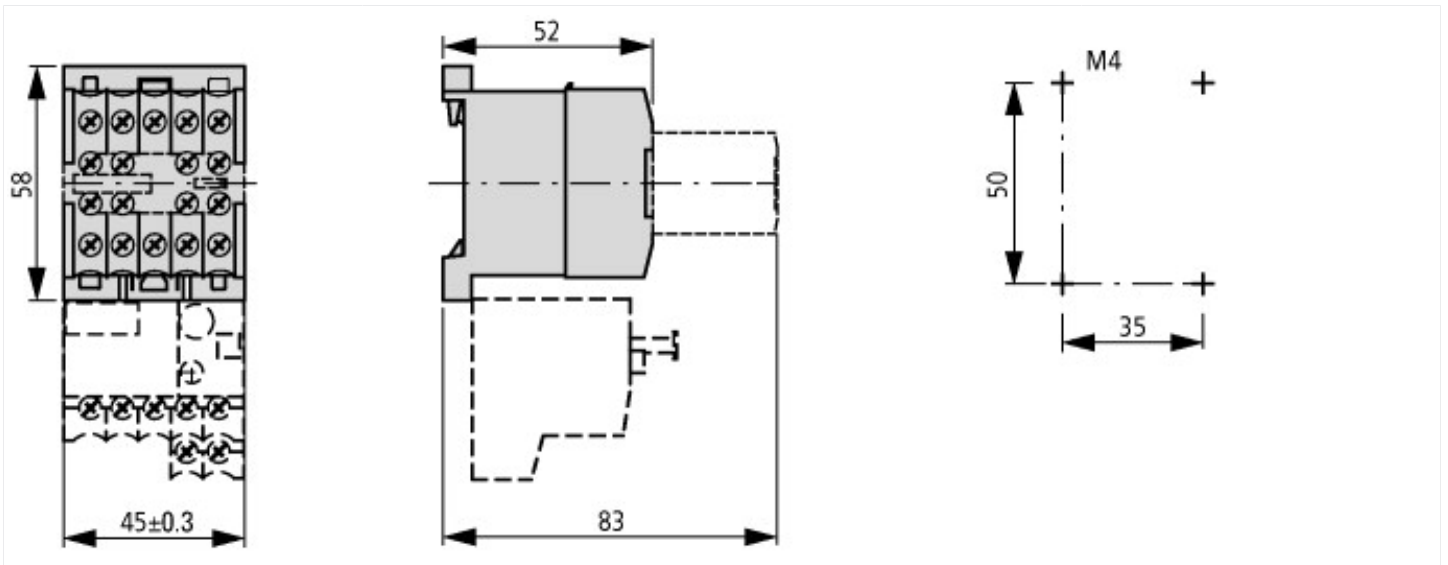

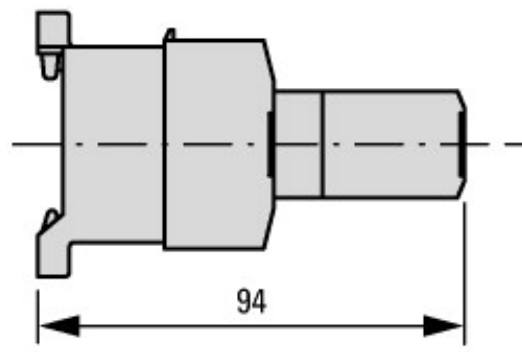
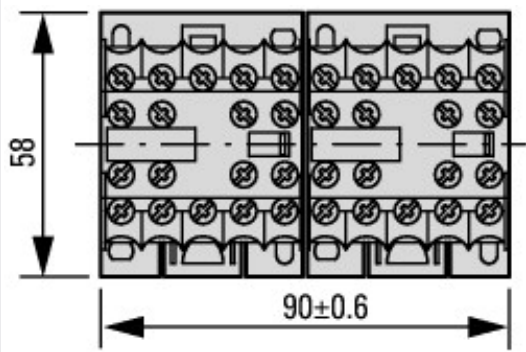

2DILE-... + MVDILE + ...DILE
2DILE-...-G + MVDILE + ...DILE

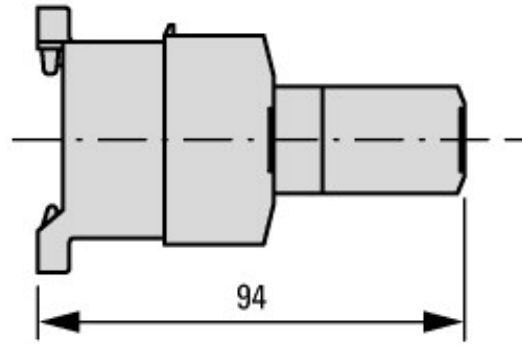
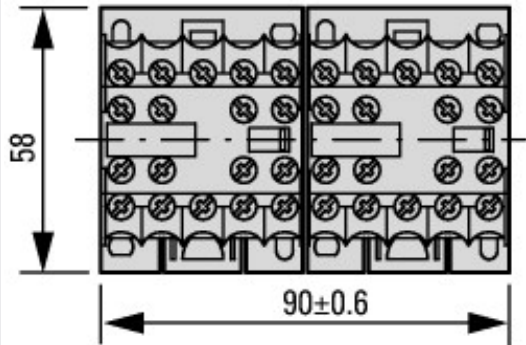

2DILE-... + MVDILE + ...DILE
2DILE-...-G + MVDILE + ...DILE

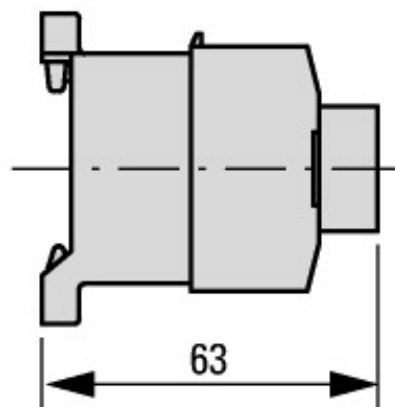
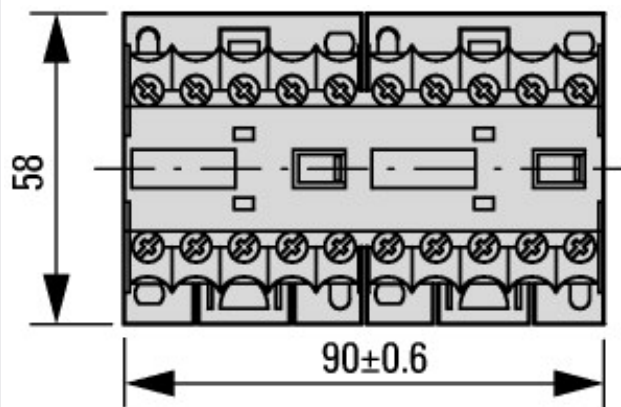

2DILE-... + MVDILE
2DILE-...-G + MVDILE

Assets (links)

Declaration of CE Conformity

00003110

Instruction Leaflets

IL03407009Z2018_04

Additional product information (links)

IL03407009Z (AWA2100-0882) mini contactor relay

IL03407009Z (AWA2100-0882) mini contactor relay ftp://ftp.moeller.net/DOCUMENTATION/AWA_INSTRUCTIONS/IL03407009Z2020_05.pdf