



Sensor fixing, M30 sensors, inductive

Part no. E57KNZ30  
 Catalog No. 136200  
 Alternate Catalog No. E57KNZ30

Delivery program

Basic function			Accessories
Accessories			Sensor fixing
<b>For use with</b>			
For use with			M30 sensors, inductive

Design verification as per IEC/EN 61439

Technical data for design verification			
Operating ambient temperature min.		°C	-25
Operating ambient temperature max.		°C	70

Technical data ETIM 7.0

Sensors (EG000026) / Accessories for position switches (EC002594)			
Electric engineering, automation, process control engineering / Binary sensor technology, safety-related sensor technology / Position switch / Position switch (accessories) (ecI@ss10.0.1-27-27-06-92 [AFR520003])			
Type of accessory			Other

Approvals

Product Standards			none
-------------------	--	--	------

Dimensions

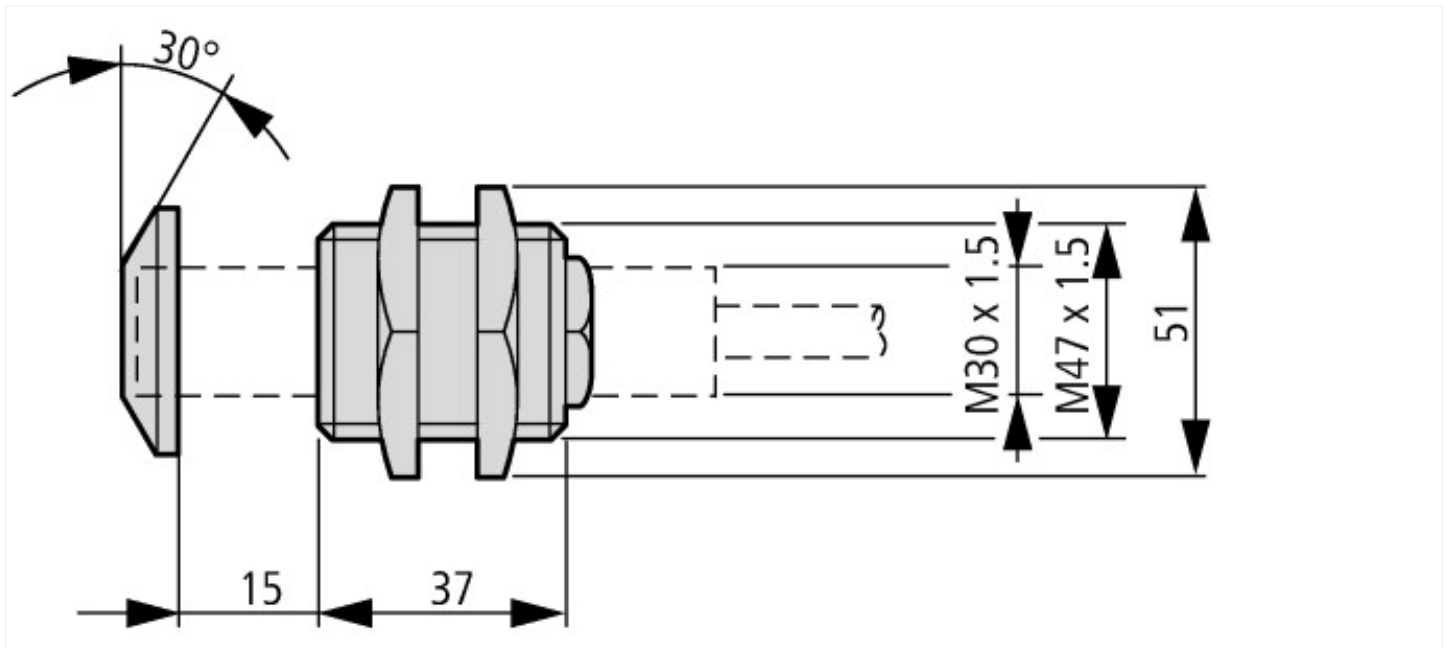

Assets (links)

Declaration of CE Conformity  
 00003158