



Proximity switch, E57 Premium+ Series, 1 NC, 3-wire, 6 - 48 V DC, M12 x 1 mm, S_n= 10 mm, Semi-shielded, PNP, Stainless steel, 2 m connection cable

Part no. E57-12LE10-B1
Catalog No. 135905
Alternate Catalog No. E57-12LE10-B1

Delivery program

Basic function			Inductive Sensors
Product range			E57 Premium+ Series
Connection			3-wire
Design (outer dimensions)		mm	M12 x 1
Rated operational voltage	U _e		6 - 48 V DC
Rated switching distance	S _n	mm	10
Type of mounting			Semi-shielded
Switching type			PNP
For connection of:			2 m connection cable
Contacts			
N/C = Normally closed			1 NC
Material			Stainless steel
Degree of Protection			IP67

Technical data

General

Standards			IEC/EN 60947-5-2
Ambient temperature			-25 - +70
Mechanical shock resistance		g	30 Shock duration 11 ms
Degree of Protection			IP67

Characteristics

Rated switching distance			
Rated switching distance	S _n	mm	10
Repetition accuracy of S _n		%	3
Temperature drift of S _n		%	10
Switching hysteresis of S _n		%	15
Rated operational voltage	U _e		6 - 48 V DC
Operating current in the switched state at 24 V DC	I _b	mA	10
Maximum load current	I _e	mA	< 500 (6 - 30 V DC)
Voltage drop at I _e	U _d	V	2.5
Switching Frequency		Hz	800
Residual current through the load in the blocked state at 230 V AC and 24 V DC	I _r	mA	0.1
Switching state display		LED	Red
Connection			3-wire
Contacts			
N/C = Normally closed			1 NC
Style			
Design (outer dimensions)		mm	M12 x 1
For connection of:			2 m connection cable
Material			Stainless steel

Design verification as per IEC/EN 61439

Technical data for design verification			
--	--	--	--

Operating ambient temperature min.	°C	-25
Operating ambient temperature max.	°C	70

Technical data ETIM 7.0

Sensors (EG000026) / Inductive proximity switch (EC002714)

Electric engineering, automation, process control engineering / Binary sensor technology, safety-related sensor technology / Proximity switch / Inductive proximity switch (ec@ss10.0.1-27-27-01-01 [AGZ376015])

Width sensor	mm	0
Height of sensor	mm	0
Length of sensor	mm	72.7
Diameter sensor	mm	12
Mechanical mounting condition for sensor		Not flat
Switching distance	mm	10
Suitable for safety functions		No
Type of switch function		Breaker contact
Type of switching output		PNP
Type of electric connection		Cable
Number of semiconductor outputs with signalling function		1
Number of contact energized outputs with signalling function		0
Number of protected semiconductor outputs		0
Number of protected contact energized outputs		0
Type of actuation		Metallic Target
Type of interface		None
Type of interface for safety communication		None
Construction type housing		Cylinder, screw-thread
Coating housing		Other
Cascadable		No
Category according to EN 954-1		B
SIL according to IEC 61508		None
Performance level acc. EN ISO 13849-1		None
Max. output current at protected output	mA	0
Supply voltage	V	6 - 48
Rated control supply voltage Us at AC 50HZ	V	0 - 0
Rated control supply voltage Us at AC 60HZ	V	0 - 0
Rated control supply voltage Us at DC	V	6 - 48
Voltage type		DC
Switching frequency	Hz	800
With monitoring function downstream switching devices		No
Material housing		Metal
Compression-resistant		No
Explosion safety category for gas		None
Explosion safety category for dust		None
Interference resistance to magnetic fields		

Approvals

Product Standards		none
CSA File No.		none
CSA Class No.		none
Max. Voltage Rating		48 V DC
Degree of Protection		IEC: IP67, IP69K; UL/CSA Type: 4, 4x, 6, 6P, 12, 13

Dimensions

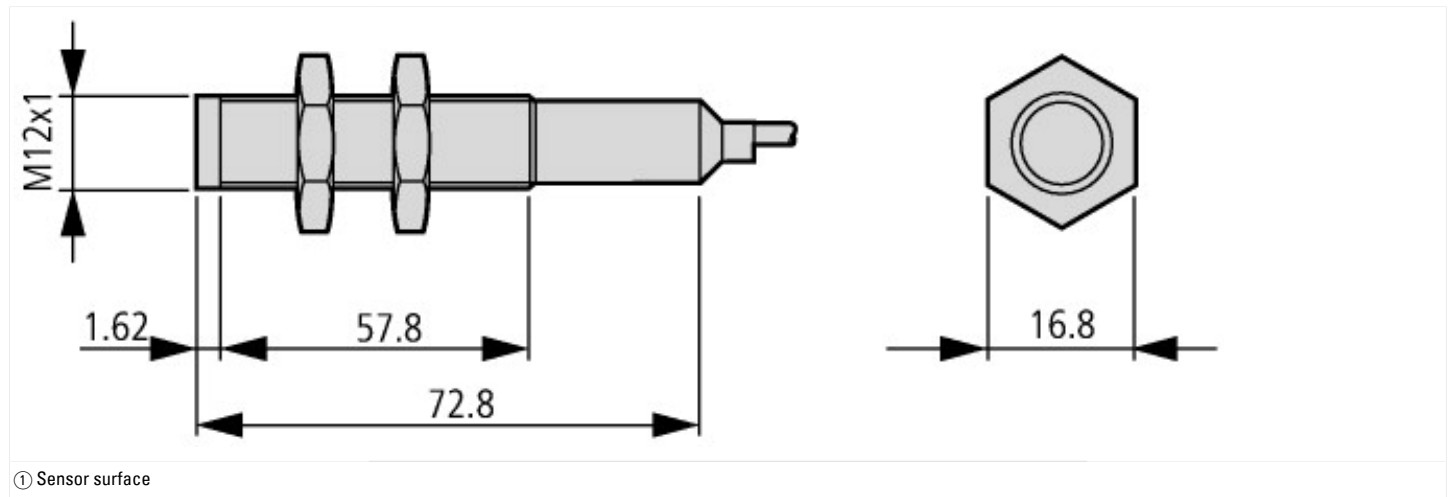

Assets (links)

Declaration of CE Conformity

00003158

Instruction Leaflets

IL05301003Z2018_05

Additional product information (links)

IL05301003Z Premium Plus Series Inductive Sensors +Short, +Miniature

IL05301003Z Premium Plus Series Inductive Sensors +Short, +Miniature

ftp://ftp.moeller.net/DOCUMENTATION/AWA_INSTRUCTIONS/IL05301003Z2018_05.pdf