



Three-phase control isolating safety transformer, 16 kVA, Rated input voltage 50 – 950 ± 5 % V, Rated output voltage 18.5 – 1000 V

Part no. DTZ16(*/*)*
Catalog No. 914814
Alternate Catalog No. -

Delivery program

Product range		Three-phase DTZ control transformers
Rated input voltage	V	50 – 950 ± 5 %
Rated output voltage	V	18.5 – 1000
Rated power	kVA	16
Short-time rating	kVA	40
Cu factor 37,00		

Notes

- Transformers with the rated output voltages ≤ 50 V can be used as safety transformers to IEC/EN 61558.
- Enclosure IP65 on request.

When ordering, the part no. must include the following details:

DTZ0.1(*/*)*

- Wildcard ≙ Nominal input voltage
- 2nd Wildcard ≙ Nominal output voltage
- 3rd Wildcard ≙ Configuration

Ordering example

- desired part no. DTZ0.1
- Desired rated input voltage 200 V
- Desired rated output voltage 18.5 V
- Desired configuration Dy(n)5

The correct part no. is

DTZ0.1(200/18.5)DY(N)5

Additional tappings → 931897

Design verification as per IEC/EN 61439

Technical data for design verification			
Rated operational current for specified heat dissipation	I _n	A	0
Heat dissipation per pole, current-dependent	P _{vid}	W	0
Equipment heat dissipation, current-dependent	P _{vid}	W	0
Static heat dissipation, non-current-dependent	P _{vs}	W	520
Heat dissipation capacity	P _{diss}	W	0
Operating ambient temperature min.		°C	-25
Operating ambient temperature max.		°C	40
IEC/EN 61439 design verification			
10.2 Strength of materials and parts			
10.2.2 Corrosion resistance			
			Meets the product standard's requirements.
10.2.3.1 Verification of thermal stability of enclosures			
			Meets the product standard's requirements.
10.2.3.2 Verification of resistance of insulating materials to normal heat			
			Meets the product standard's requirements.
10.2.3.3 Verification of resistance of insulating materials to abnormal heat and fire due to internal electric effects			
			Meets the product standard's requirements.
10.2.4 Resistance to ultra-violet (UV) radiation			
			Meets the product standard's requirements.
10.2.5 Lifting			
			Does not apply, since the entire switchgear needs to be evaluated.
10.2.6 Mechanical impact			
			Does not apply, since the entire switchgear needs to be evaluated.
10.2.7 Inscriptions			
			Meets the product standard's requirements.
10.3 Degree of protection of ASSEMBLIES			
			Does not apply, since the entire switchgear needs to be evaluated.

10.4 Clearances and creepage distances		Meets the product standard's requirements.
10.5 Protection against electric shock		Does not apply, since the entire switchgear needs to be evaluated.
10.6 Incorporation of switching devices and components		Does not apply, since the entire switchgear needs to be evaluated.
10.7 Internal electrical circuits and connections		Is the panel builder's responsibility.
10.8 Connections for external conductors		Is the panel builder's responsibility.
10.9 Insulation properties		
10.9.2 Power-frequency electric strength		Is the panel builder's responsibility.
10.9.3 Impulse withstand voltage		Is the panel builder's responsibility.
10.9.4 Testing of enclosures made of insulating material		Is the panel builder's responsibility.
10.10 Temperature rise		The panel builder is responsible for the temperature rise calculation. Eaton will provide heat dissipation data for the devices.
10.11 Short-circuit rating		Is the panel builder's responsibility. The specifications for the switchgear must be observed.
10.12 Electromagnetic compatibility		Is the panel builder's responsibility. The specifications for the switchgear must be observed.
10.13 Mechanical function		The device meets the requirements, provided the information in the instruction leaflet (IL) is observed.

Technical data ETIM 7.0

Low-voltage industrial components (EG000017) / Three-phase control transformer (EC002485)			
Electric engineering, automation, process control engineering / Transformer, converter, coil / Control transformer / Three-phase control transformer (ecl@ss10.0.1-27-03-13-01 [AAB619015])			
Built as safety transformer			Yes
Built as isolating transformer			Yes
Built as energy saving transformer			No
Primary voltage 1	V		50 - 950
Primary voltage 2	V		50 - 950
Primary voltage 3	V		50 - 950
Primary voltage 4	V		50 - 950
Primary voltage 5	V		50 - 950
Primary voltage 6	V		50 - 950
Primary voltage 7	V		0 - 0
Primary voltage 8	V		0 - 0
Primary voltage 9	V		0 - 0
Primary voltage 10	V		0 - 0
Secondary voltage 1	V		18.5 - 1000
Secondary voltage 2	V		18.5 - 1000
Secondary voltage 3	V		18.5 - 1000
Secondary voltage 4	V		18.5 - 1000
Secondary voltage 5	V		18.5 - 1000
Secondary voltage 6	V		18.5 - 1000
Secondary voltage 7	V		0 - 0
Secondary voltage 8	V		0 - 0
Secondary voltage 9	V		0 - 0
Secondary voltage 10	V		0 - 0
Wiring system			Other
Rated power	VA		16000
Type of insulation material acc. IEC 85			B
Short-circuit-proof			No
Relative short circuit voltage	%		4.5
Conductor material			Copper
Width	mm		450
Height	mm		434
Depth	mm		221
Degree of protection (IP)			IP00
Degree of protection (NEMA)			Other

Approvals

Product Standards		IEC/EN 61558-2-2; CE marking
UL File No.		-
UL Category Control No.		XPTQ2, XPTQ8
CSA File No.		-
CSA Class No.		-
North America Certification		-
Specially designed for North America		No
Suitable for		Branch circuits
Max. Voltage Rating		600 V AC
Degree of Protection		IEC: IP00, UL/CSA Type: -

Dimensions

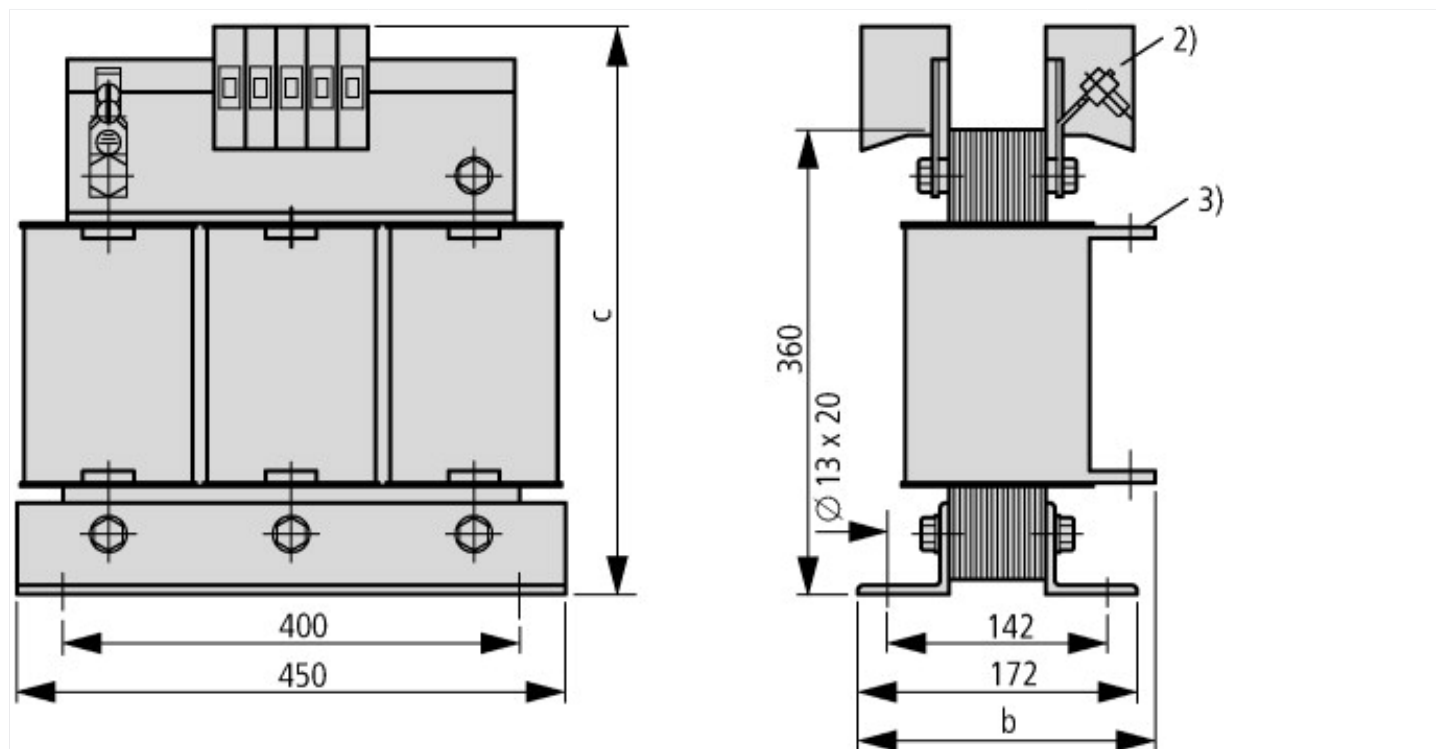

	b	c
18.5 V	-	-
24 V	221	434
42 V	221	434
110 V	204	434
230-690 V	204	434

① The higher rated operating voltage applies

② Terminals \leq 25 A

③ Connection lugs > 63 A

Assets (links)

Declaration of CE Conformity

00003099