



Pushbutton, classic, flat, maintained, 1 N/C, cable (black) with m8 plug, 4 pole, 0.5 m



Powering Business Worldwide™

Part no. C22-DR-X-K01-P31
 Catalog No. 185647

Delivery program

Product range			RMQ compact solution
Basic function			Pushbutton actuators
Single unit/Complete unit			Complete unit
Design			Flat maintained
Connection type			Cable (black) with M8 plug, 4 pole
Cable Length		m	0.5

Button plate

button plate			Without button plate
Degree of Protection			IP66, IP67, IP69 (front) IP65 (on rear)
Front ring			Bezel: titanium
Connection to SmartWire-DT			no

Contacts

N/C = Normally closed			1 NC
Notes			= safety function, by positive opening to IEC/EN 60947-5-1

Actuator travel and actuation force as per DIN EN 60947-5-1, K.5.4.1

	mm		4.65
Maximum travel	mm		5.7
Minimum force for positive opening	N		15

Contact sequence			
------------------	--	--	--

Contact travel = Contact closed = Contact open

Contact diagram			 Zw = 4.5 mm
Positive opening (ZW)			yes

Technical data

General

Standards			IEC/EN 60947-5-1 VDE 0660
Certifications			CE, UL, CSA
Lifespan, mechanical	Operations	$\times 10^6$	> 1
Operating frequency	Operations/h		≤ 3600
Actuating force		n	≤ 5
Plug tightening torque		N/m	0.6
Tightening torque Threaded ring		Nm	2
Climatic proofing			Damp heat, constant, to IEC 60068-2-78 Damp heat, cyclic, to IEC 60068-2-30
Degree of Protection			IP66, IP67, IP69 (front) IP65 (on rear)
Ambient temperature			
Open		°C	-30 - +70
Storage		°C	-30 - +80
Mounting position			As required
Mechanical shock resistance, shock duration 11 ms		g	> 30

Contacts

Rated impulse withstand voltage	U_{imp}	V AC	800
Rated insulation voltage	U_i	V	30
Overvoltage category/pollution degree			III/3
Control circuit reliability			
At 17 V DC/7 mA	H_F		N/C contact: statistically determined 1 failure per 0.9×10^6 Operations
Max. short-circuit protective device			
Fuse	gG/gL	A	4
Rated conditional short-circuit current	I_q	kA	1

Switching capacity

Rated operational current	I_e	A	
AC-15			
24 V	I_e	A	4
DC-13			
24 V	I_e	A	3

Cable characteristics

Design			M8
Cable Length		m	0.5
Material characteristic			PUR
Diameter	\varnothing	mm	4.7

Design verification as per IEC/EN 61439

Technical data for design verification			
Operating ambient temperature min.		°C	-30
Operating ambient temperature max.		°C	70

Technical data ETIM 7.0

Low-voltage industrial components (EG000017) / Push button, complete (EC001028)			
Electric engineering, automation, process control engineering / Low-voltage switch technology / Command and alarm device / Push-button actuator, complete unit (ecl@ss10.0.1-27-37-12-28 [AKF046014])			
Number of command positions			1
Type of button			Flat
Colour button			Without button plate
Construction type lens			Round
Hole diameter		mm	22
Width opening		mm	0
Height opening		mm	0
Suitable for illumination			No

Switching function latching		Yes
Spring-return		No
Supply voltage lamp	V	0
Number of contacts as normally open contact		0
Number of contacts as normally closed contact		1
Number of contacts as change-over contact		0
Type of electric connection		Other
With front ring		Yes
Material front ring		Plastic
Colour front ring		Grey
Degree of protection (IP)		Other
Degree of protection (NEMA)		Other

Approvals

Product Standards		IEC/EN 60947-5-1; UL 508; CAN/CSA-C22.2 No. 14-18 and No. 94.2-15; CE marking
UL File No.		E29184
UL Category Control No.		NKCR
CSA File No.		165628
CSA Class No.		321103
North America Certification		UL listed, CSA certified
Degree of Protection		2, 12

Dimensions

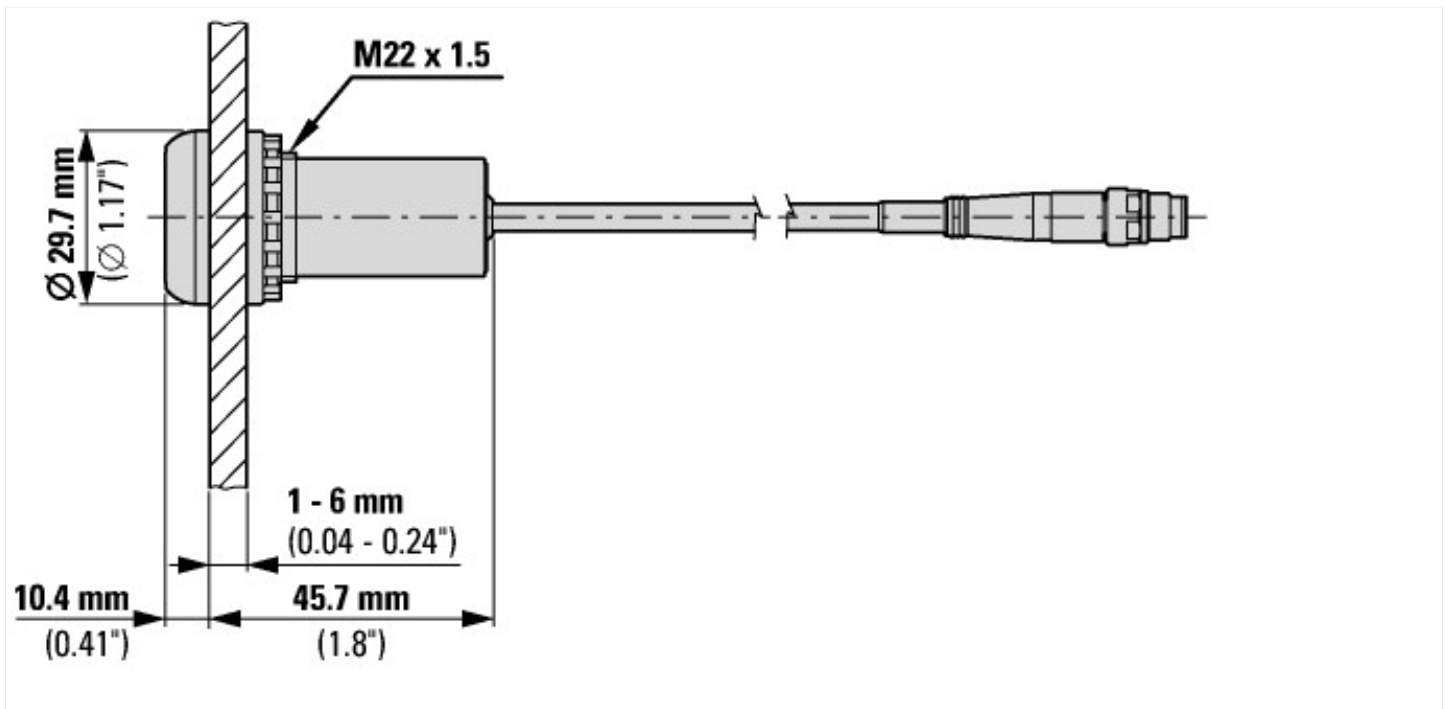

Assets (links)

Declaration of CE Conformity

00003256

Instruction Leaflets

IL047016ZU2018_06

Additional product information (links)

IL047016ZU RMQ compact solution

IL047016ZU RMQ compact solution ftp://ftp.moeller.net/DOCUMENTATION/AWA_INSTRUCTIONS/IL047016ZU2018_06.pdf