





Key-operated actuator, RMQ Compact, maintained, 1 N/O, Screw connection, 2 positions, MS3, Bezel: titanium

Part no. C22-WRS-MS3-K10
Catalog No. 136811
Alternate Catalog No. C22-WRS-MS3-K10

Delivery program

Product range		RMQ Compact
Basic function		Key-operated buttons
Single unit/Complete unit		Complete unit maintained
Function:		
		60°
Connection type		Screw connection Not suitable for master key systems 2 positions
Lock mechanism		MS3
Key withdrawable in position		
		I
		0
Degree of Protection		IP66
Front ring		Bezel: titanium
Connection to SmartWire-DT		no
Contacts		
N/O = Normally open		1 N/O
Contact sequence		
Contact travel <input checked="" type="checkbox"/> = Contact closed <input type="checkbox"/> = Contact open		
Contact diagram		
Information about equipment supplied		With 1 key

Technical data

General		
Standards		IEC/EN 60947-5-1

			VDE 0660
Lifespan, mechanical	Operations	$\times 10^6$	> 0.1
Operating frequency	Operations/h		≤ 100
Operating torque		Nm	≤ 0.5
Climatic proofing			Damp heat, constant, to IEC 60068-2-78 Damp heat, cyclic, to IEC 60068-2-30
Degree of Protection			IP66
Mounting position			As required
Terminal capacities		mm ²	
Solid		mm ²	2 x 0.5 - 1.5
Flexible with ferrule		mm ²	2 x 0.5 - 1.5
Tightening torque for terminal screw		Nm	0.8

Contacts

Rated impulse withstand voltage	U_{imp}	V AC	4000
Rated insulation voltage	U_i	V	250
Rated conditional short-circuit current	I_q	kA	1
Overvoltage category/pollution degree			III/3
Control circuit reliability			
at 24 V DC/5 mA	H_F	Fault probability	values follow probability
at 5 V DC/1 mA	H_F	Fault probability	values follow probability
Max. short-circuit protective device			
Fuse	gG/gL	A	10

Technical data ETIM 7.0

Low-voltage industrial components (EG000017) / Selector switch, complete (EC001029)			
Electric engineering, automation, process control engineering / Low-voltage switch technology / Command and alarm device / Selector switch, complete unit (ecl@ss10.0.1-27-37-12-43 [ACN984011])			
Number of switch positions			2
Type of control element			Key
Suitable for illumination			No
With light source			No
Colour button			Black
Hole diameter		mm	22.5
Width opening		mm	0
Height opening		mm	0
Switching function latching			Yes
Spring-return			No
Degree of protection (IP)			IP66
Degree of protection (NEMA)			
Supply voltage		V	0 - 0
Number of contacts as normally open contact			1
Number of contacts as normally closed contact			0
Number of contacts as change-over contact			0
Type of electric connection			Screw connection
With front ring			Yes
Material front ring			Plastic
Colour front ring			Other

Approvals

Product Standards			IEC/EN 60947-5-1; UL 508; CAN/CSA-C22.2 No. 14-05 und 94-M91; CE marking
UL File No.			E29184
UL Category Control No.			NKCR
CSA File No.			165628
CSA Class No.			321103

Dimensions

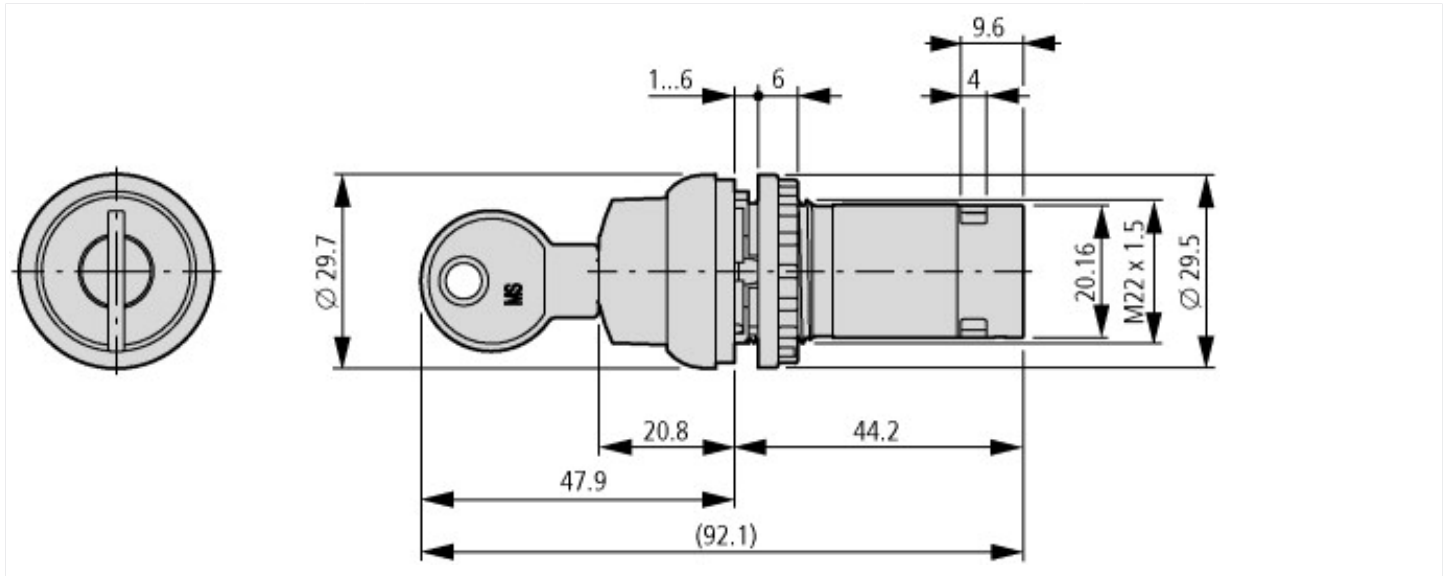

Additional product information (links)

IL04716025Z RMQ-Titan: compact programm

IL04716025Z RMQ-Titan: compact programm

https://es-assets.eaton.com/DOCUMENTATION/AWA_INSTRUCTIONS/IL04716025Z2021_05.pdf