







Key-operated actuator, RMQ Compact, momentary, 1 NC, 1 N/O, Screw connection, 2 positions, MS7, Bezel: titanium

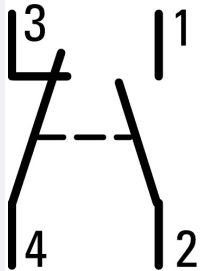

Part no. C22-WS-MS7-K11
Catalog No. 136742
Alternate Catalog No. C22-WS-MS7-K11

Delivery program

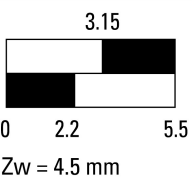
| | | |
|---|----|--|
| Product range | | RMQ Compact |
| Basic function | | Key-operated buttons |
| Single unit/Complete unit | | Complete unit momentary |
| Function: | | |
| | |  40° |
| Connection type | | Screw connection Not suitable for master key systems 2 positions |
| Lock mechanism | | MS7 |
| Key withdrawable in position | | |
| | | 0 |
| Degree of Protection | | IP66 |
| Front ring | | Bezel: titanium |
| Connection to SmartWire-DT | | no |
| Contacts | | |
| N/C = Normally closed | | 1 NC  |
| N/O = Normally open | | 1 N/O |
| Notes | |  = safety function, by positive opening to IEC/EN 60947-5-1 |
| Actuator travel and actuation force as per DIN EN 60947-5-1, K.5.4.1 | | |
| | mm | 4.65 |
| Maximum travel | mm | 5.7 |
| Minimum force for positive opening | N | 20 |
| Contact sequence | |  |
| Contact travel  = Contact closed  = Contact open | | |
| Contact diagram | |  |
| Positive opening (ZW) | | yes |
| Information about equipment supplied | | With 1 key |

Technical data

General

| | | | |
|--------------------------------------|--------------|-------------------|--|
| Standards | | | IEC/EN 60947-5-1 VDE 0660 |
| Lifespan, mechanical | Operations | x 10 ⁶ | > 0.1 |
| Operating frequency | Operations/h | | ≤ 100 |
| Operating torque | | Nm | ≤ 0.5 |
| Climatic proofing | | | Damp heat, constant, to IEC 60068-2-78 Damp heat, cyclic, to IEC 60068-2-30 |
| Degree of Protection | | | IP66 |
| Mounting position | | | As required |
| Terminal capacities | | mm ² | |
| Solid | | mm ² | 2 x 0.5 - 1.5 |
| Flexible with ferrule | | mm ² | 2 x 0.5 - 1.5 |
| Tightening torque for terminal screw | | Nm | 0.8 |

Contacts

| | | | |
|---|------------------|-------------------|---------------------------|
| Rated impulse withstand voltage | U _{imp} | V AC | 4000 |
| Rated insulation voltage | U _i | V | 250 |
| Rated conditional short-circuit current | I _q | kA | 1 |
| Overvoltage category/pollution degree | | | III/3 |
| Control circuit reliability | | | |
| at 24 V DC/5 mA | H _F | Fault probability | values follow probability |
| at 5 V DC/1 mA | H _F | Fault probability | values follow probability |
| Max. short-circuit protective device | | | |
| Fuse | gG/gL | A | 10 |

Technical data ETIM 7.0

| | | | |
|--|--|----|------------------|
| Low-voltage industrial components (EG000017) / Selector switch, complete (EC001029) | | | |
| Electric engineering, automation, process control engineering / Low-voltage switch technology / Command and alarm device / Selector switch, complete unit (ecl@ss10.0.1-27-37-12-43 [ACN984011]) | | | |
| Number of switch positions | | | 2 |
| Type of control element | | | Key |
| Suitable for illumination | | | No |
| With light source | | | No |
| Colour button | | | Black |
| Hole diameter | | mm | 22.5 |
| Width opening | | mm | 0 |
| Height opening | | mm | 0 |
| Switching function latching | | | No |
| Spring-return | | | Yes |
| Degree of protection (IP) | | | IP66 |
| Degree of protection (NEMA) | | | |
| Supply voltage | | V | 0 - 0 |
| Number of contacts as normally open contact | | | 1 |
| Number of contacts as normally closed contact | | | 1 |
| Number of contacts as change-over contact | | | 0 |
| Type of electric connection | | | Screw connection |
| With front ring | | | Yes |
| Material front ring | | | Plastic |
| Colour front ring | | | Other |

Approvals

| | | | |
|-------------------------|--|--|--|
| Product Standards | | | IEC/EN 60947-5-1; UL 508; CAN/CSA-C22.2 No. 14-05 und 94-M91; CE marking |
| UL File No. | | | E29184 |
| UL Category Control No. | | | NKCR |

| | | |
|-----------------------------|--|--------------------------|
| CSA File No. | | 165628 |
| CSA Class No. | | 321103 |
| North America Certification | | UL listed, CSA certified |
| Degree of Protection | | 1,3R,4X,12,13 |

Dimensions

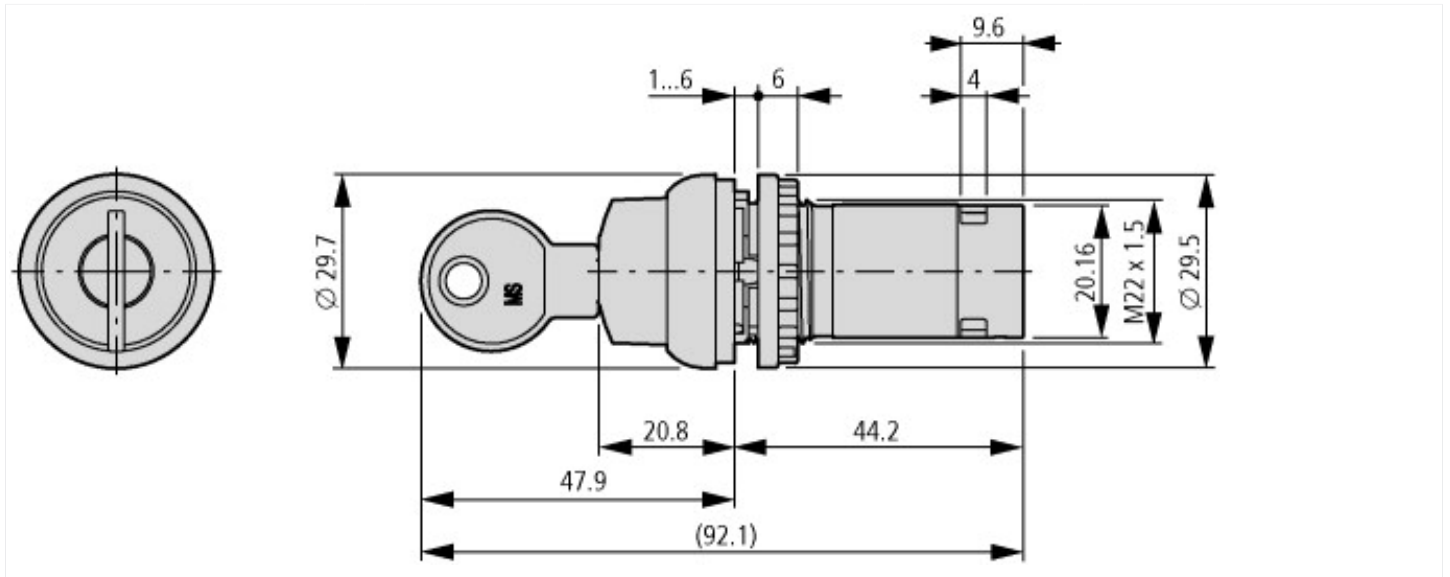

Additional product information (links)

IL04716025Z RMQ-Titan: compact programm

IL04716025Z RMQ-Titan: compact programm https://es-assets.eaton.com/DOCUMENTATION/AWA_INSTRUCTIONS/IL04716025Z2021_05.pdf