

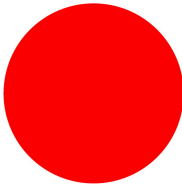

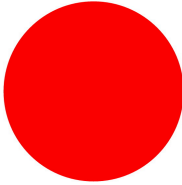

**Illuminated pushbutton actuator, Flat, momentary, 1 NC, Screw connection, LED Red, red, Blank, 230 V AC, Bezel: titanium**

**Part no.** C22-DL-R-K01-230  
**Catalog No.** 136625  
**Alternate Catalog No.** C22-DL-R-K01-230

**Delivery program**

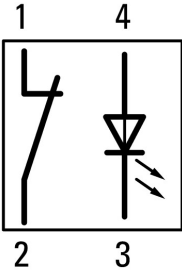
Product range			RMQ Compact
Basic function			Illuminated pushbutton actuators
Single unit/Complete unit			Complete unit
Design			Flat momentary
Connection type			Screw connection
<b>Colour</b>			
LED			
LED			Red
<b>Button plate</b>			
button plate			red
Button plate			
			Blank
Rated operational voltage LED			230 V AC
Name			None
Degree of Protection			IP66, IP67, IP69
Front ring			Bezel: titanium
Connection to SmartWire-DT			no
<b>Contacts</b>			
N/C = Normally closed			1 NC 
Notes			 = safety function, by positive opening to IEC/EN 60947-5-1
<b>Actuator travel and actuation force as per DIN EN 60947-5-1, K.5.4.1</b>			
	mm		4.65
Maximum travel	mm		5.7
Minimum force for positive opening	N		15
Contact sequence			

Contact travel  = Contact closed  = Contact open

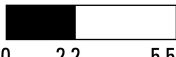
Contact diagram		
Positive opening (ZW)		yes

## Technical data

### General

Standards			IEC/EN 60947-5-1 VDE 0660
Lifespan, mechanical	Operations	x 10 <sup>6</sup>	> 5
Operating frequency	Operations/h		≤ 3600
Actuating force		n	≤ 5
Climatic proofing			Damp heat, constant, to IEC 60068-2-78 Damp heat, cyclic, to IEC 60068-2-30
Degree of Protection			IP66, IP67, IP69
Ambient temperature			
Open		°C	-25 - +70
Storage		°C	- -30 - + 80
Mounting position			As required
Terminal capacities		mm <sup>2</sup>	
Solid		mm <sup>2</sup>	2 x 0.5 - 1.5_x
Flexible with ferrule		mm <sup>2</sup>	2 x 0.5 - 1.5_x
Tightening torque for terminal screw		Nm	0.8

### Contacts

Rated impulse withstand voltage	U <sub>imp</sub>	V AC	4000
Rated insulation voltage	U <sub>i</sub>	V	250
Rated conditional short-circuit current	I <sub>q</sub>	kA	1
Overvoltage category/pollution degree			III/3
Control circuit reliability			
at 24 V DC/5 mA	H <sub>F</sub>	Fault probability	values follow probability
at 5 V DC/1 mA	H <sub>F</sub>	Fault probability	values follow probability
Max. short-circuit protective device			
Fuse	gG/gL	A	10

## Design verification as per IEC/EN 61439

Technical data for design verification			
Operating ambient temperature min.		°C	-25
Operating ambient temperature max.		°C	70

## Technical data ETIM 7.0

Low-voltage industrial components (EG000017) / Push button, complete (EC001028)			
Electric engineering, automation, process control engineering / Low-voltage switch technology / Command and alarm device / Push-button actuator, complete unit (ecl@ss10.0.1-27-37-12-28 [AKF046014])			
Number of command positions			1
Type of button			Flat
Colour button			Red
Construction type lens			Round
Hole diameter		mm	22.5
Width opening		mm	0
Height opening		mm	0
Suitable for illumination			Yes
Switching function latching			No
Spring-return			Yes

Supply voltage lamp	V	230
Number of contacts as normally open contact		0
Number of contacts as normally closed contact		1
Number of contacts as change-over contact		0
Type of electric connection		Screw connection
With front ring		Yes
Material front ring		Plastic
Colour front ring		Other
Degree of protection (IP)		Other
Degree of protection (NEMA)		

## Approvals

Product Standards		IEC/EN 60947-5-1; UL 508; CAN/CSA-C22.2 No. 14-05 und 94-M91; CE marking
UL File No.		E29184
UL Category Control No.		NKCR
CSA File No.		165628
CSA Class No.		321103
North America Certification		UL listed, CSA certified
Degree of Protection		1,3R,4X,12,13

## Dimensions

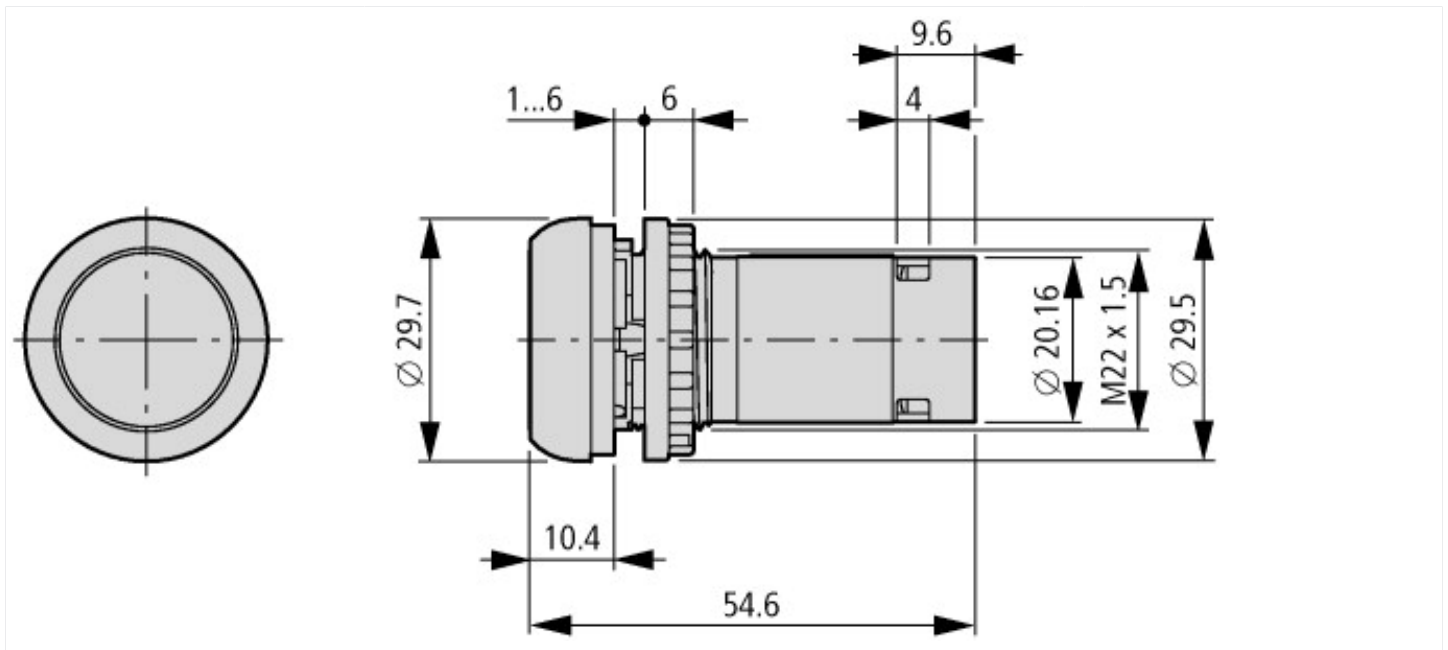

## Additional product information (links)

IL04716025Z RMQ-Titan: compact programm

IL04716025Z RMQ-Titan: compact programm [https://es-assets.eaton.com/DOCUMENTATION/AWA\\_INSTRUCTIONS/IL04716025Z2021\\_05.pdf](https://es-assets.eaton.com/DOCUMENTATION/AWA_INSTRUCTIONS/IL04716025Z2021_05.pdf)