







**Key-operated actuator, RMQ Compact, momentary, 1 NC, 1 N/O, Screw connection, 3 positions, Ronis 455, Bezel: titanium**

**Part no.** C22-WS3-RS-K11  
**Catalog No.** 132823  
**Alternate Catalog No.** C22-WS3-RS-K11

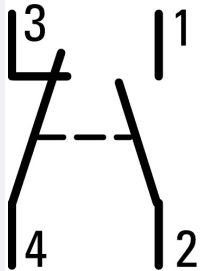
**Delivery program**

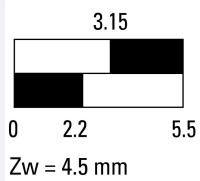
Product range		RMQ Compact
Basic function		Key-operated buttons
Single unit/Complete unit		Complete unit momentary
<b>Function:</b>		
		40°  40°
Connection type		Screw connection Not suitable for master key systems 3 positions
Lock mechanism		Ronis 455
<b>Key withdrawable in position</b>		
		0
Degree of Protection		IP66
Front ring		Bezel: titanium
Connection to SmartWire-DT		no
<b>Contacts</b>		
N/C = Normally closed		1 NC 
N/O = Normally open		1 N/O
Notes		 = safety function, by positive opening to IEC/EN 60947-5-1
<b>Actuator travel and actuation force as per DIN EN 60947-5-1, K.5.4.1</b>		
	mm	4.65
Maximum travel	mm	5.7
Minimum force for positive opening	N	20
Contact sequence		
<b>Contact travel  = Contact closed  = Contact open</b>		
Contact diagram		
Positive opening (ZW)		yes
Information about equipment supplied		With 1 key

## Technical data

### General

Standards			IEC/EN 60947-5-1 VDE 0660
Lifespan, mechanical	Operations	x 10 <sup>6</sup>	> 0.1
Operating frequency	Operations/h		≤ 100
Operating torque		Nm	≤ 0.5
Climatic proofing			Damp heat, constant, to IEC 60068-2-78 Damp heat, cyclic, to IEC 60068-2-30
Degree of Protection			IP66
Mounting position			As required
Terminal capacities		mm <sup>2</sup>	
Solid		mm <sup>2</sup>	2 x 0.5 - 1.5
Flexible with ferrule		mm <sup>2</sup>	2 x 0.5 - 1.5
Tightening torque for terminal screw		Nm	0.8

### Contacts

Rated impulse withstand voltage	U <sub>imp</sub>	V AC	4000
Rated insulation voltage	U <sub>i</sub>	V	250
Rated conditional short-circuit current	I <sub>q</sub>	kA	1
Overvoltage category/pollution degree			III/3
Control circuit reliability			
at 24 V DC/5 mA	H <sub>F</sub>	Fault probability	values follow probability
at 5 V DC/1 mA	H <sub>F</sub>	Fault probability	values follow probability
Max. short-circuit protective device			
Fuse	gG/gL	A	10

## Technical data ETIM 7.0

Low-voltage industrial components (EG000017) / Selector switch, complete (EC001029)			
Electric engineering, automation, process control engineering / Low-voltage switch technology / Command and alarm device / Selector switch, complete unit (ecl@ss10.0.1-27-37-12-43 [ACN984011])			
Number of switch positions			3
Type of control element			Key
Suitable for illumination			No
With light source			No
Colour button			Black
Hole diameter		mm	22.5
Width opening		mm	0
Height opening		mm	0
Switching function latching			No
Spring-return			Yes
Degree of protection (IP)			IP66
Degree of protection (NEMA)			
Supply voltage		V	0 - 0
Number of contacts as normally open contact			1
Number of contacts as normally closed contact			1
Number of contacts as change-over contact			0
Type of electric connection			Screw connection
With front ring			Yes
Material front ring			Plastic
Colour front ring			Other

## Approvals

Product Standards			IEC/EN 60947-5-1; UL 508; CAN/CSA-C22.2 No. 14-05 und 94-M91; CE marking
UL File No.			E29184
UL Category Control No.			NKCR

CSA File No.	165628
CSA Class No.	321103
North America Certification	UL listed, CSA certified
Degree of Protection	1,3R,4X,12,13

## Dimensions

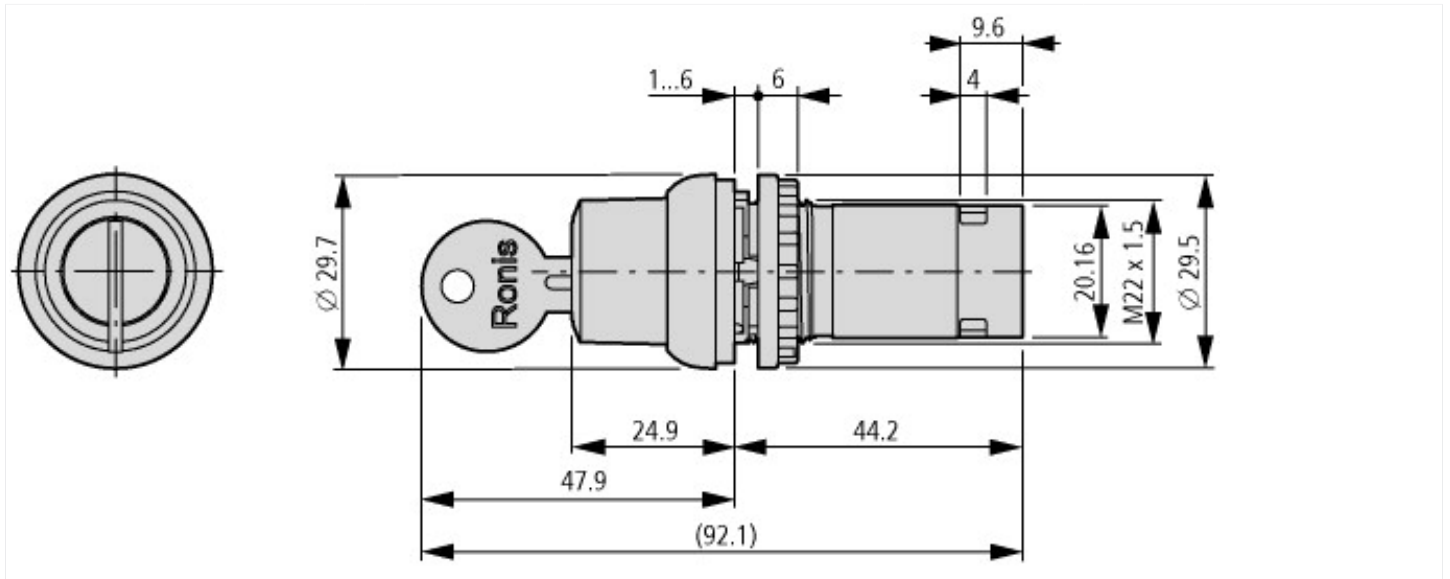

## Additional product information (links)

IL04716025Z RMQ-Titan: compact programm

IL04716025Z RMQ-Titan: compact programm [https://es-assets.eaton.com/DOCUMENTATION/AWA\\_INSTRUCTIONS/IL04716025Z2021\\_05.pdf](https://es-assets.eaton.com/DOCUMENTATION/AWA_INSTRUCTIONS/IL04716025Z2021_05.pdf)