

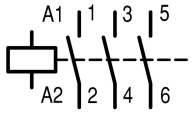

Contactor, 3 pole, 380 V 400 V 22 kW, 600 V 60 Hz, AC operation, Screw terminals

Part no. DILM50(600V60HZ)
Catalog No. 277825
Alternate Catalog No. XTCE050D00D

Delivery program

Product range				Contactors
Application				Contactors for Motors
Subrange				Contactors up to 170 A, 3 pole
Utilization category				AC-1: Non-inductive or slightly inductive loads, resistance furnaces NAC-3: Normal AC induction motors: starting, switch off during running AC-4: Normal AC induction motors: starting, plugging, reversing, inching
				
Notes				Also suitable for motors with efficiency class IE3. IE3-ready devices are identified by the logo on their packaging.
Connection technique				Screw terminals
Number of poles				3 pole
Rated operational current				
AC-3				
Notes				At maximum permissible ambient temperature (open.)
380 V 400 V	I_e	A		50
AC-1				
Conventional free air thermal current, 3 pole, 50 - 60 Hz				
Open				
at 40 °C	$I_{th} = I_e$	A		80
enclosed	I_{th}	A		58
Conventional free air thermal current, 1 pole				
open	I_{th}	A		162
enclosed	I_{th}	A		145
Max. rating for three-phase motors, 50 - 60 Hz				
AC-3				
220 V 230 V	P	kW		15.5
380 V 400 V	P	kW		22
660 V 690 V	P	kW		30
AC-4				
220 V 230 V	P	kW		6
380 V 400 V	P	kW		10
660 V 690 V	P	kW		14
Contact sequence				
Instructions				Contacts to EN 50 012.
Can be combined with auxiliary contact				DILM150-XHI(V).. DILM1000-XHI(V)..
Actuating voltage				600 V 60 Hz
Voltage AC/DC				AC operation
Connection to SmartWire-DT				no

Technical data

General

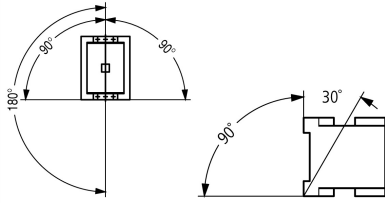
Standards			IEC/EN 60947, VDE 0660, UL, CSA
Lifespan, mechanical			
AC operated	Operations	$\times 10^6$	10
Operating frequency, mechanical			
AC operated	Operations/h		5000
Climatic proofing			Damp heat, constant, to IEC 60068-2-78 Damp heat, cyclic, to IEC 60068-2-30
Ambient temperature			
Open		°C	-25 - +60
Enclosed		°C	- 25 - 40
Storage		°C	- 40 - 80
Mounting position			
Mechanical shock resistance (IEC/EN 60068-2-27)			
Half-sinusoidal shock, 10 ms			
Main contacts			
N/O contact		g	10
Auxiliary contacts			
N/O contact		g	7
N/C contact		g	5
Mechanical shock resistance (IEC/EN 60068-2-27) when tabletop-mounted			
Half-sinusoidal shock, 10 ms			
Main contacts			
N/O contact		g	10
Auxiliary contacts			
N/O contact		g	7
N/C contact		g	5
Degree of Protection			IP00
Protection against direct contact when actuated from front (EN 50274)			Finger and back-of-hand proof
Altitude		m	Max. 2000
Weight			
AC operated		kg	0.87
Screw connector terminals			
Terminal capacity main cable			
Solid		mm ²	1 x (0.75 - 16) 2 x (0.75 - 16)
Flexible with ferrule		mm ²	1 x (0.75 - 35) 2 x (0.75 - 25)
Stranded		mm ²	1 x (16 - 50) 2 x (16 - 35)
Solid or stranded		AWG	single 14 - 1, double 14 - 2
Flat conductor	Lamellenzahl x Breite x Dicke	mm	2 x (6 x 9 x 0.8)
Stripping length		mm	14
Terminal screw			M6
Tightening torque		Nm	3.3
Tool			
Pozidriv screwdriver		Size	2
Standard screwdriver		mm	0.8 x 5.5 1 x 6
Terminal capacity control circuit cables			

Solid		mm ²	1 x (0.75 - 4) 2 x (0.75 - 2.5)
Flexible with ferrule		mm ²	1 x (0.75 - 2.5) 2 x (0.75 - 2.5)
Solid or stranded		AWG	18 - 14
Stripping length		mm	10
Terminal screw			M3.5
Tightening torque		Nm	1.2
Tool			
Pozidriv screwdriver		Size	2
Standard screwdriver		mm	0.8 x 5.5 1 x 6

Main conducting paths

Rated impulse withstand voltage	U_{imp}	V AC	8000
Overvoltage category/pollution degree			III/3
Rated insulation voltage	U_i	V AC	690
Rated operational voltage	U_e	V AC	690
Safe isolation to EN 61140			
between coil and contacts		V AC	440
between the contacts		V AC	440
Making capacity (p.f. to IEC/EN 60947)			
	Up to 690 V	A	700
Breaking capacity			
220 V 230 V		A	500
380 V 400 V		A	500
500 V		A	500
660 V 690 V		A	320
Short-circuit rating			
Short-circuit protection maximum fuse			
Type "2" coordination			
400 V	gG/gL 500 V	A	80
690 V	gG/gL 690 V	A	63
Type "1" coordination			
400 V	gG/gL 500 V	A	160
690 V	gG/gL 690 V	A	80

AC

AC-1			
Rated operational current			
Conventional free air thermal current, 3 pole, 50 - 60 Hz			
Open			
at 40 °C	$I_{th} = I_e$	A	80
at 50 °C	$I_{th} = I_e$	A	71
at 55 °C	$I_{th} = I_e$	A	68
at 60 °C	$I_{th} = I_e$	A	65
enclosed	I_{th}	A	58
Conventional free air thermal current, 1 pole			
open	I_{th}	A	162
enclosed	I_{th}	A	145
AC-3			
Rated operational current			
Open, 3-pole: 50 - 60 Hz			
Notes			At maximum permissible ambient temperature (open.)
220 V 230 V	I_e	A	50
240 V	I_e	A	50
380 V 400 V	I_e	A	50
415 V	I_e	A	50

440V	I _e	A	50
500 V	I _e	A	50
660 V 690 V	I _e	A	32
380 V 400 V	I _e	A	50
Motor rating	P	kWh	
220 V 230 V	P	kW	15.5
240V	P	kW	17
380 V 400 V	P	kW	22
415 V	P	kW	30
440 V	P	kW	32
500 V	P	kW	36
660 V 690 V	P	kW	30
AC-4			
Open, 3-pole: 50 – 60 Hz			
220 V 230 V	I _e	A	21
240 V	I _e	A	21
380 V 400 V	I _e	A	21
415 V	I _e	A	21
440 V	I _e	A	21
500 V	I _e	A	21
660 V 690 V	I _e	A	17
Motor rating	P	kWh	
220 V 230 V	P	kW	6
240 V	P	kW	6.5
380 V 400 V	P	kW	10
415 V	P	kW	11
440 V	P	kW	12
500 V	P	kW	13
660 V 690 V	P	kW	14

DC

Rated operational current, open			
DC-1			
60 V	I _e	A	60
110 V	I _e	A	50
220 V	I _e	A	45

Current heat loss

3 pole, at I _{th} (60°)		W	16.7
Current heat loss at I _e to AC-3/400 V		W	9.9
Impedance per pole		mΩ	1.9

Magnet systems

Voltage tolerance			
AC operated	Pick-up	x U _c	0.8 - 1.1
Drop-out voltage AC operated	Drop-out	x U _c	0.3 - 0.6
Power consumption of the coil in a cold state and 1.0 x U _S			
50 Hz	Pick-up	VA	149
50 Hz	Sealing	VA	16
50 Hz	Sealing	W	4.1
60 Hz	Pick-up	VA	178
60 Hz	Sealing	VA	19
60 Hz	Sealing	W	4.1
Duty factor		% DF	100
Changeover time at 100 % U _S (recommended value)			
Main contacts			
AC operated			

Closing delay	ms	12 - 18
Opening delay	ms	8 - 13
Arcing time	ms	10

Electromagnetic compatibility (EMC)

Emitted interference		to EN 60947-1
Interference immunity		to EN 60947-1

Design verification as per IEC/EN 61439

Technical data for design verification			
Rated operational current for specified heat dissipation	I_n	A	50
Heat dissipation per pole, current-dependent	P_{vid}	W	3.3
Equipment heat dissipation, current-dependent	P_{vid}	W	9.9
Static heat dissipation, non-current-dependent	P_{vs}	W	4.1
Heat dissipation capacity	P_{diss}	W	0
Operating ambient temperature min.		°C	-25
Operating ambient temperature max.		°C	60
IEC/EN 61439 design verification			
10.2 Strength of materials and parts			
10.2.2 Corrosion resistance			
			Meets the product standard's requirements.
10.2.3.1 Verification of thermal stability of enclosures			
			Meets the product standard's requirements.
10.2.3.2 Verification of resistance of insulating materials to normal heat			
			Meets the product standard's requirements.
10.2.3.3 Verification of resistance of insulating materials to abnormal heat and fire due to internal electric effects			
			Meets the product standard's requirements.
10.2.4 Resistance to ultra-violet (UV) radiation			
			Meets the product standard's requirements.
10.2.5 Lifting			
			Does not apply, since the entire switchgear needs to be evaluated.
10.2.6 Mechanical impact			
			Does not apply, since the entire switchgear needs to be evaluated.
10.2.7 Inscriptions			
			Meets the product standard's requirements.
10.3 Degree of protection of ASSEMBLIES			
			Does not apply, since the entire switchgear needs to be evaluated.
10.4 Clearances and creepage distances			
			Meets the product standard's requirements.
10.5 Protection against electric shock			
			Does not apply, since the entire switchgear needs to be evaluated.
10.6 Incorporation of switching devices and components			
			Does not apply, since the entire switchgear needs to be evaluated.
10.7 Internal electrical circuits and connections			
			Is the panel builder's responsibility.
10.8 Connections for external conductors			
			Is the panel builder's responsibility.
10.9 Insulation properties			
10.9.2 Power-frequency electric strength			
			Is the panel builder's responsibility.
10.9.3 Impulse withstand voltage			
			Is the panel builder's responsibility.
10.9.4 Testing of enclosures made of insulating material			
			Is the panel builder's responsibility.
10.10 Temperature rise			
			The panel builder is responsible for the temperature rise calculation. Eaton will provide heat dissipation data for the devices.
10.11 Short-circuit rating			
			Is the panel builder's responsibility. The specifications for the switchgear must be observed.
10.12 Electromagnetic compatibility			
			Is the panel builder's responsibility. The specifications for the switchgear must be observed.
10.13 Mechanical function			
			The device meets the requirements, provided the information in the instruction leaflet (IL) is observed.

Technical data ETIM 7.0

Low-voltage industrial components (EG000017) / Power contactor, AC switching (EC000066)			
Electric engineering, automation, process control engineering / Low-voltage switch technology / Contactor (LV) / Power contactor, AC switching (ecl@ss10.0.1-27-37-10-03 [AAB718015])			
Rated control supply voltage U_s at AC 50HZ	V		0 - 0
Rated control supply voltage U_s at AC 60HZ	V		600 - 600
Rated control supply voltage U_s at DC	V		0 - 0
Voltage type for actuating			AC
Rated operation current I_e at AC-1, 400 V	A		80
Rated operation current I_e at AC-3, 400 V	A		50
Rated operation power at AC-3, 400 V	kW		22
Rated operation current I_e at AC-4, 400 V	A		21

Rated operation power at AC-4, 400 V	kW	10
Rated operation power NEMA	kW	29.8
Modular version		No
Number of auxiliary contacts as normally open contact		0
Number of auxiliary contacts as normally closed contact		0
Type of electrical connection of main circuit		Screw connection
Number of normally closed contacts as main contact		0
Number of main contacts as normally open contact		3

Characteristics

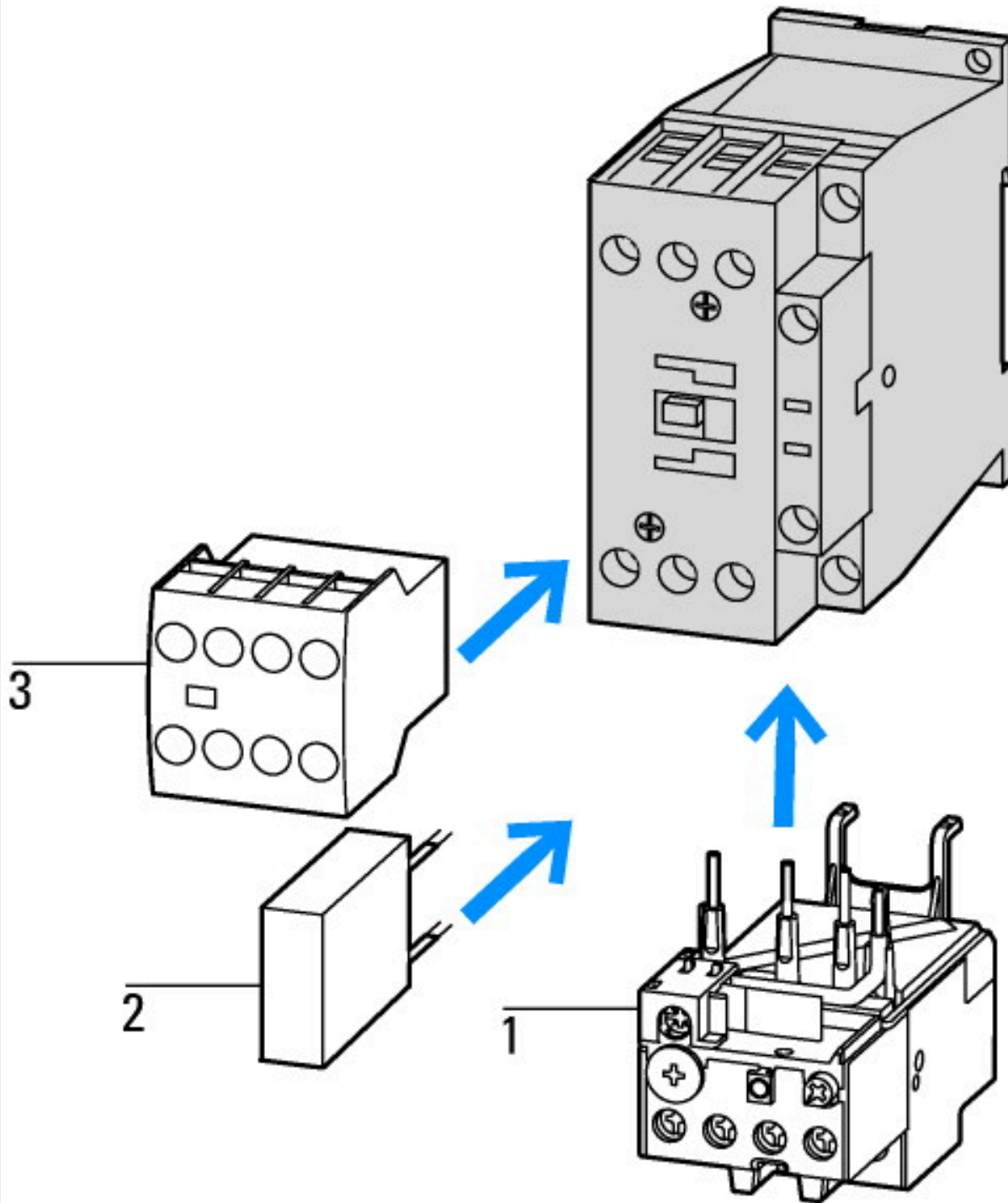

- 1: Overload relay
- 2: Suppressor
- 3: Auxiliary contact modules

DILM1000-XHI(V)11-...

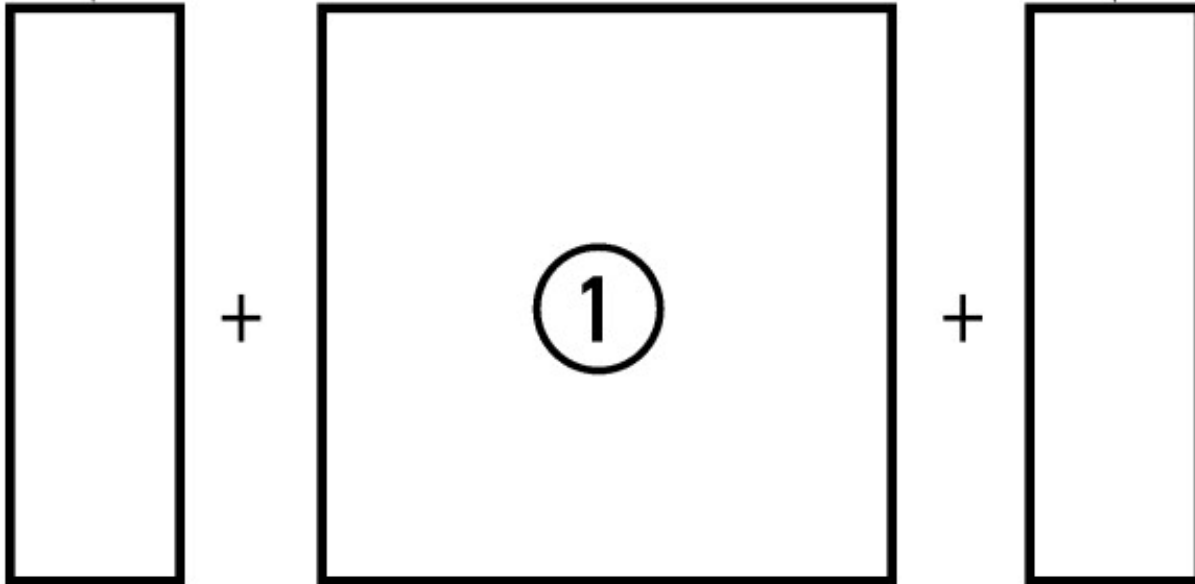

on the side: 2 x DILM1000-XHI(V)11-SI; surface mounting: 1 x DILM150-XHIA11
 on the side: 2 x DILM1000-XHI(V)11-SA; surface mounting: 1 x DILM150-XHI (2 pole)
 on the side: 1 x DILM1000-XHI(V)11-SI; surface mounting: 1 x DILM150-XHIA22
 on the side: 1 x DILM1000-XHI(V)11-SA; surface mounting: 1 x DILM150-XHI (4 pole)

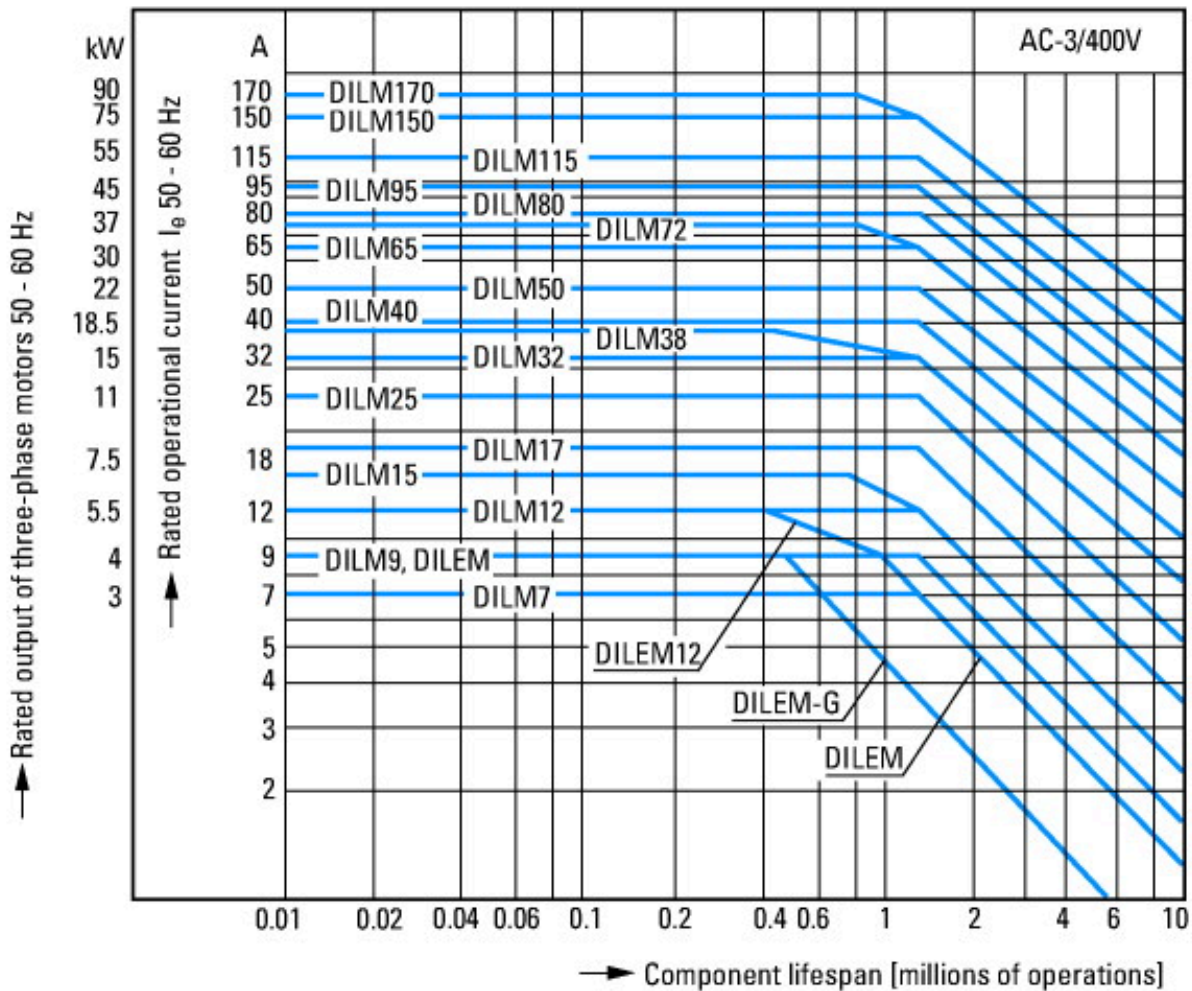

Squirrel-cage motor
 Operating characteristics
 Starting: from rest
 Stopping: after attaining full running speed
 Electrical characteristics
 Make: up to 6 x rated motor current
 Break: up to 1 x rated motor current
 Utilization category
 100 % AC-3
 Typical applications
 Compressors
 Lifts
 Mixers
 Pumps
 Escalators
 Agitators
 Fans
 Conveyor belts
 Centrifuges
 Hinged flaps
 Bucket-elevators
 Air conditioning system
 General drives in manufacturing and processing machines

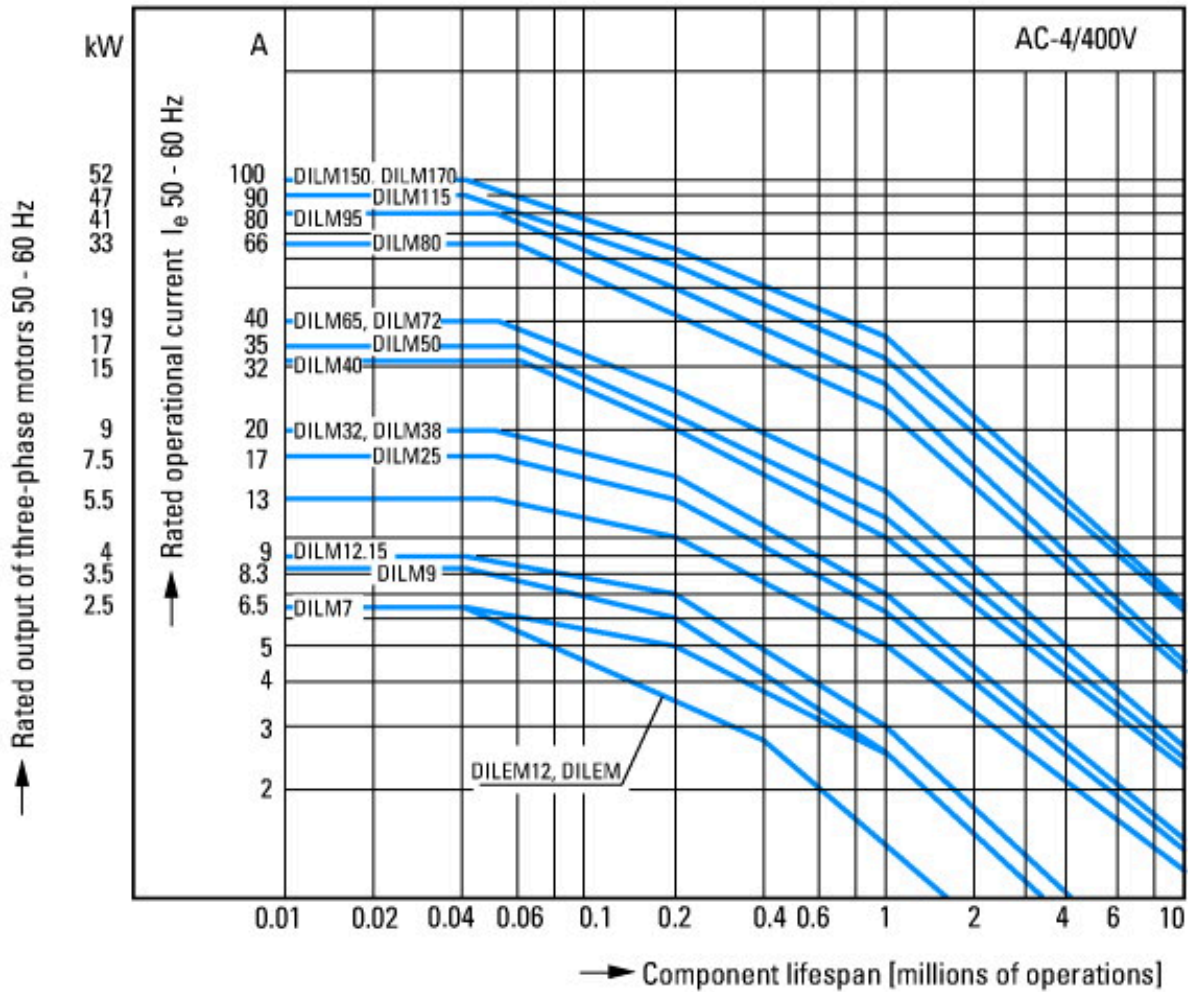

Extreme switching duty
 Squirrel-cage motor
 Operating characteristics
 Inching, plugging, reversing
 Electrical characteristics
 Make: up to 6 x rated motor current
 Break: up to 6 x rated motor current
 Utilization category
 100 % AC-4
 Typical applications
 Printing presses
 Wire-drawing machines
 Centrifuges
 Special drives for manufacturing and processing machines

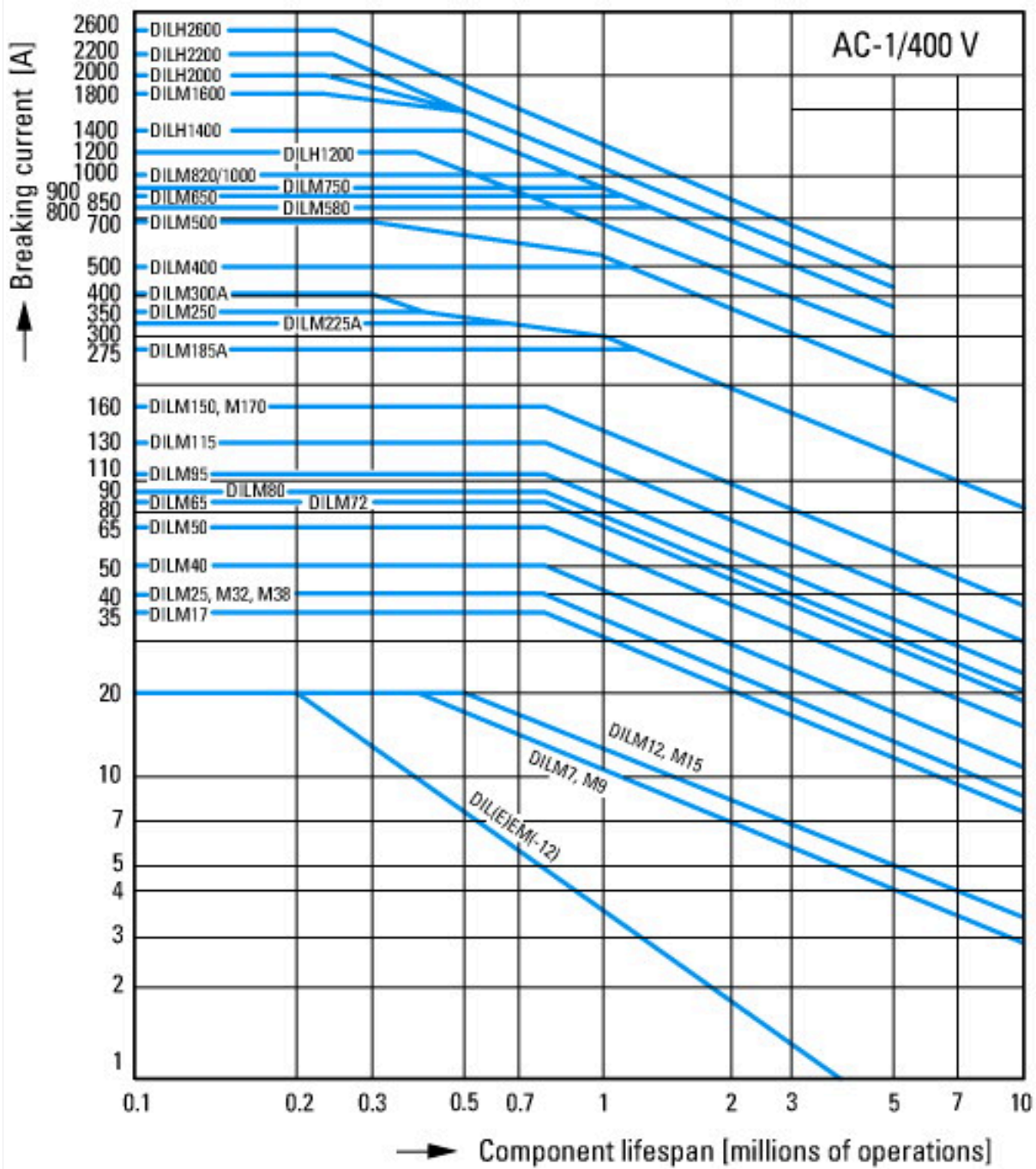

Switching conditions for non-motor consumers, 3 pole, 4 pole
 Operating characteristics
 Non inductive and slightly inductive loads
 Electrical characteristics
 Switch on: 1 x rated operational current
 Switch off: 1 x rated operational current
 Utilization category
 100 % AC-1
 Typical examples of application
 Electric heat

Dimensions

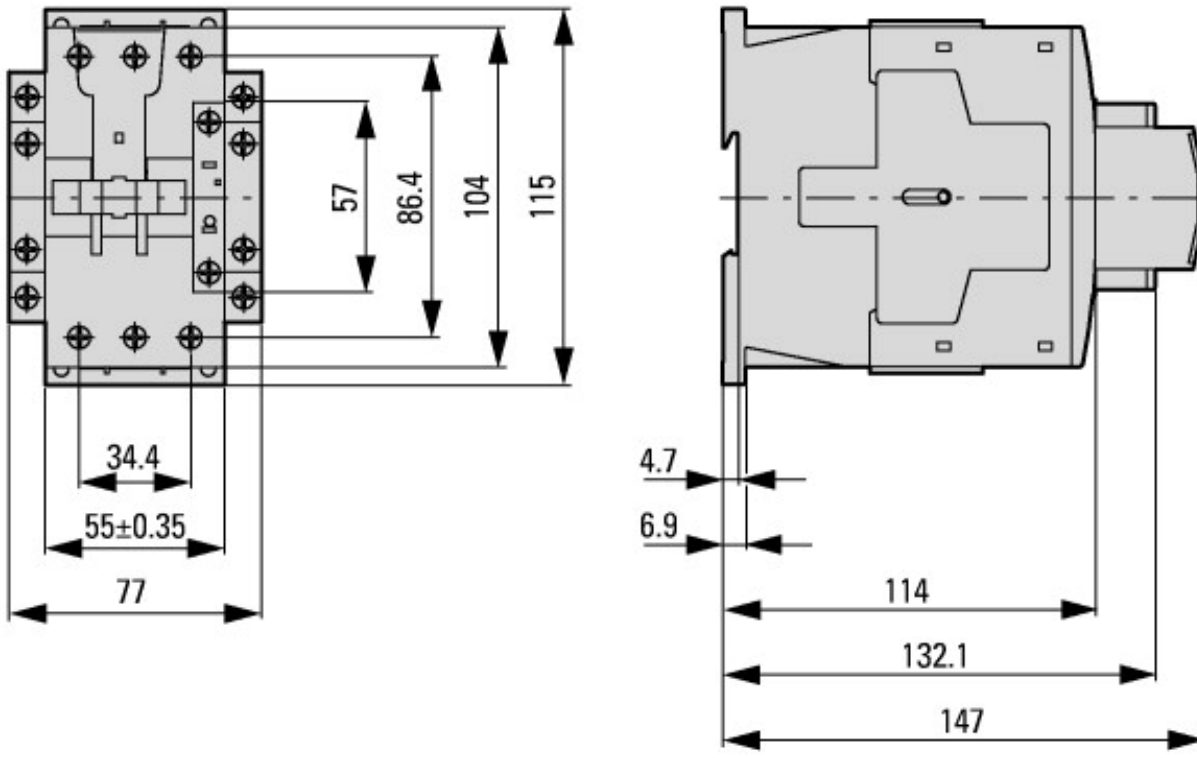

Contacteur with auxiliary contact module

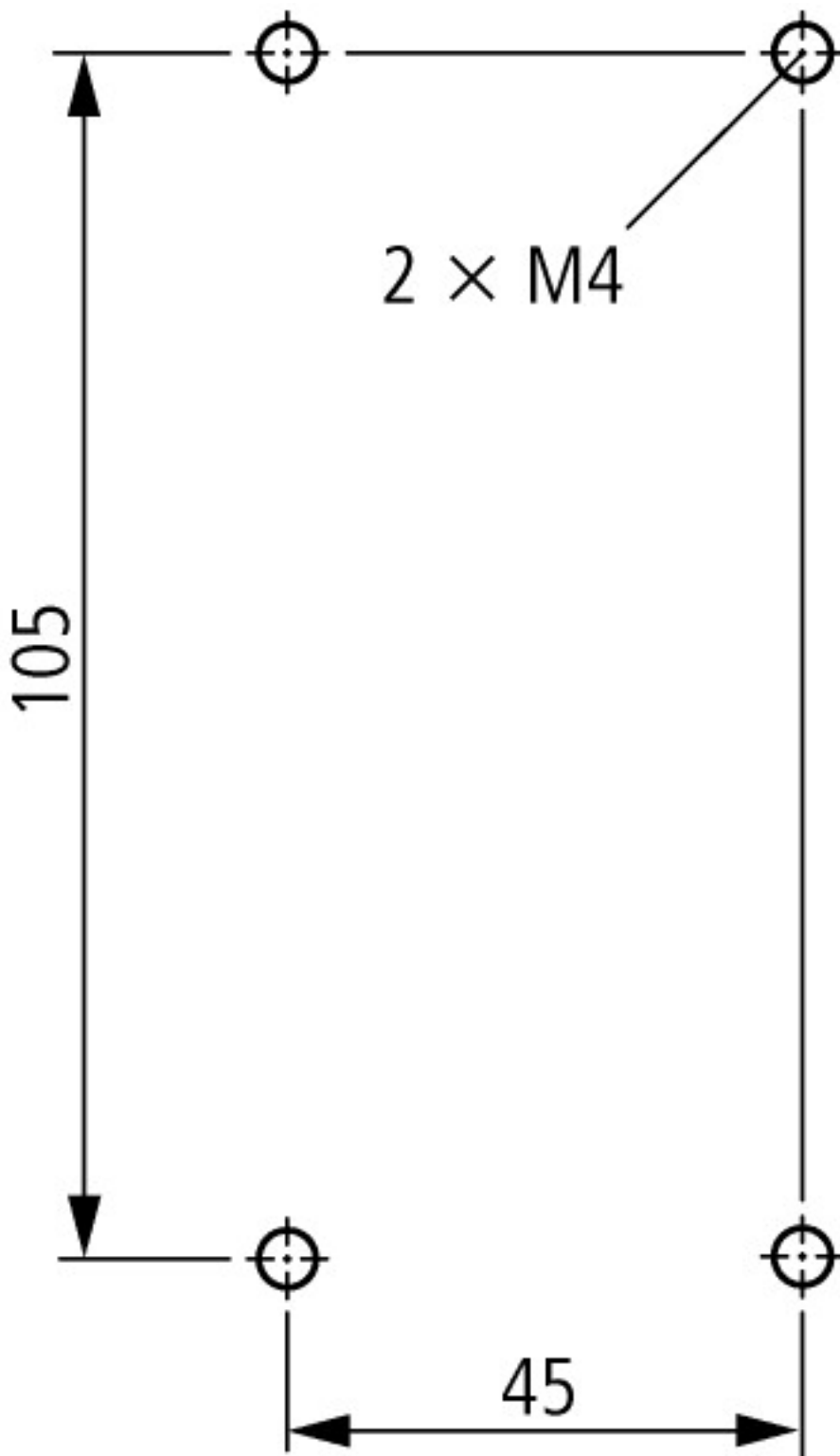

Lateral clearance to earthed parts: 6 mm

DILM40...DILM72
DILMC40...DILMC65
DILMF40...DILMF65

Assets (links)

Declaration of CE Conformity

00003252

Instruction Leaflets

IL03407033Z2018_03

Additional product information (links)

IL03407033Z (AWA2100-2247) DILM contactor, basic device

IL03407033Z (AWA2100-2247) DILM contactor, basic device ftp://ftp.moeller.net/DOCUMENTATION/AWA_INSTRUCTIONS/IL03407033Z2018_03.pdf

Motor starters and "Special Purpose Ratings" for the North American market	http://www.eaton.eu/ecm/groups/public/@pub/@europe/@electrical/documents/content/pct_3258146.pdf
Switchgear of Power Factor Correction Systems	http://www.moeller.net/binary/ver_techpapers/ver934en.pdf
X-Start - Modern Switching Installations Efficiently Fitted and Wired Securely	http://www.moeller.net/binary/ver_techpapers/ver938en.pdf
Mirror Contacts for Highly-Reliable Information Relating to Safety-Related Control Functions	http://www.moeller.net/binary/ver_techpapers/ver944en.pdf
Effect of the Cabel Capacitance of Long Control Cables on the Actuation of Contactors	http://www.moeller.net/binary/ver_techpapers/ver949en.pdf
Switchgear for Luminaires	http://www.moeller.net/binary/ver_techpapers/ver955en.pdf
Standard Compliant and Functionally Safe Engineering Design with Mechanical Auxiliary Contacts	http://www.moeller.net/binary/ver_techpapers/ver956en.pdf
The Interaction of Contactors with PLCs	http://www.moeller.net/binary/ver_techpapers/ver957en.pdf
Busbar Component Adapters for modern Industrial control panels	http://www.moeller.net/binary/ver_techpapers/ver960en.pdf