



Reversing switches, T0, 20 A, surface mounting, 3 contact unit(s),  
 Contacts: 6, 60 °, maintained, With 0 (Off) position, 2-0-1, SOND 30, Design  
 number 123

Part no. T0-3-123/11  
 Catalog No. 222632



Similar to illustration

**Delivery program**

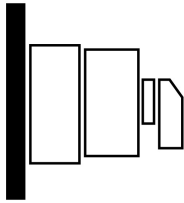
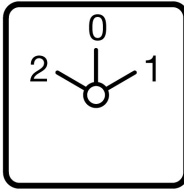
Product range			Control switches
Part group reference			T0
Basic function			Reversing switches with black thumb grip and front plate
Notes			SOND 30
Contacts			6
Degree of Protection			IP65
			<b>totally insulated</b>
Design			surface mounting 
Contact sequence			
Switching angle		°	60
Switching performance			maintained With 0 (Off) position
Design number			123
Front plate no.			 <b>FS 621</b>
front plate			2-0-1
<b>Motor rating AC-23A, 50 - 60 Hz</b>			
400 V	P	kW	5.5
Rated uninterrupted current	I <sub>u</sub>	A	20
Note on rated uninterrupted current I <sub>u</sub>			Rated uninterrupted current I <sub>u</sub> is specified for max. cross-section.
Number of contact units		contact unit(s)	3

## Technical data

### General

Standards			IEC/EN 60947, VDE 0660, IEC/EN 60204 Switch-disconnector according to IEC/EN 60947-3
Climatic proofing			Damp heat, constant, to IEC 60068-2-78 Damp heat, cyclic, to IEC 60068-2-30
Ambient temperature			
Enclosed		°C	-25 - +40
Overtoltage category/pollution degree			III/3
Rated impulse withstand voltage	$U_{imp}$	V AC	6000
Mechanical shock resistance		g	15
Mounting position			As required

### Contacts

Electrical characteristics			
Rated operational voltage	$U_e$	V AC	690
Rated uninterrupted current	$I_u$	A	20
Note on rated uninterrupted current $I_u$			Rated uninterrupted current $I_u$ is specified for max. cross-section.
Load rating with intermittent operation, class 12			
AB 25 % DF		x $I_e$	2
AB 40 % DF		x $I_e$	1.6
AB 60 % DF		x $I_e$	1.3
Short-circuit rating			
Fuse		A gG/gL	20
Rated short-time withstand current (1 s current)	$I_{cw}$	$A_{rms}$	320
Note on rated short-time withstand current $I_{cw}$			Current for a time of 1 second
Rated conditional short-circuit current	$I_q$	kA	6

### Switching capacity

$\cos \varphi$ rated making capacity as per IEC 60947-3		A	130
Rated breaking capacity $\cos \varphi$ to IEC 60947-3		A	
230 V		A	100
400/415 V		A	110
500 V		A	80
690 V		A	60
Safe isolation to EN 61140			
between the contacts		V AC	440
Current heat loss per contact at $I_e$		W	0.6
Current heat loss per auxiliary circuit at $I_e$ (AC-15/230 V)		CO	0.6
Lifespan, mechanical	Operations	x $10^6$	> 0.4
Maximum operating frequency	Operations/h		1200
AC			
AC-3			
Rating, motor load switch	P	kW	
220 V 230 V	P	kW	3
230 V Star-delta	P	kW	5.5
400 V 415 V	P	kW	5.5
400 V Star-delta	P	kW	7.5
500 V	P	kW	5.5
500 V Star-delta	P	kW	7.5
690 V	P	kW	4
690 V Star-delta	P	kW	5.5
Rated operational current motor load switch			
230 V	$I_e$	A	11.5
230 V star-delta	$I_e$	A	20
400V 415 V	$I_e$	A	11.5
400 V star-delta	$I_e$	A	20

500 V	I <sub>e</sub>	A	9
500 V star-delta	I <sub>e</sub>	A	15.6
690 V	I <sub>e</sub>	A	4.9
690 V star-delta	I <sub>e</sub>	A	8.5
AC-21A			
Rated operational current switch			
440 V	I <sub>e</sub>	A	20
AC-23A			
Motor rating AC-23A, 50 - 60 Hz			
230 V	P	kW	3
400 V 415 V	P	kW	5.5
500 V	P	kW	7.5
690 V	P	kW	5.5
Rated operational current motor load switch			
230 V	I <sub>e</sub>	A	13.3
400 V 415 V	I <sub>e</sub>	A	13.3
500 V	I <sub>e</sub>	A	13.3
690 V	I <sub>e</sub>	A	7.6
DC			
DC-1, Load-break switches L/R = 1 ms			
Rated operational current	I <sub>e</sub>	A	10
Voltage per contact pair in series		V	60
DC-21A			
Rated operational current	I <sub>e</sub>	A	1
Contacts		Quantity	1
DC-23A, motor load switch L/R = 15 ms			
24 V			
Rated operational current	I <sub>e</sub>	A	10
Contacts		Quantity	1
48 V			
Rated operational current	I <sub>e</sub>	A	10
Contacts		Quantity	2
60 V			
Rated operational current	I <sub>e</sub>	A	10
Contacts		Quantity	3
120 V			
Rated operational current	I <sub>e</sub>	A	5
Contacts		Quantity	3
240 V			
Rated operational current	I <sub>e</sub>	A	5
Contacts		Quantity	5
DC-13, Control switches L/R = 50 ms			
Rated operational current	I <sub>e</sub>	A	10
Voltage per contact pair in series		V	32
Control circuit reliability at 24 V DC, 10 mA	Fault probability	H <sub>F</sub>	< 10 <sup>-5</sup> , < 1 failure in 100,000 switching operations
<b>Terminal capacities</b>			
Solid or stranded		mm <sup>2</sup>	1 x (1 - 2,5) 2 x (1 - 2,5)
Flexible with ferrules to DIN 46228		mm <sup>2</sup>	1 x (0.75 - 2.5) 2 x (0.75 - 2.5)
Terminal screw			M3.5
Tightening torque for terminal screw		Nm	1
<b>Technical safety parameters:</b>			
<b>Notes</b>			
			B10 <sub>d</sub> values as per EN ISO 13849-1, table C1

## Rating data for approved types

Terminal capacity			
Terminal screw			M3.5

## Design verification as per IEC/EN 61439

Technical data for design verification			
Rated operational current for specified heat dissipation	$I_n$	A	20
Heat dissipation per pole, current-dependent	$P_{vid}$	W	0.6
Equipment heat dissipation, current-dependent	$P_{vid}$	W	0
Static heat dissipation, non-current-dependent	$P_{vs}$	W	0
Heat dissipation capacity	$P_{diss}$	W	0
Operating ambient temperature min.		°C	-25
Operating ambient temperature max.		°C	40
IEC/EN 61439 design verification			
10.2 Strength of materials and parts			
10.2.2 Corrosion resistance			
10.2.2.1 Verification of thermal stability of enclosures			Meets the product standard's requirements.
10.2.2.2 Verification of resistance of insulating materials to normal heat			Meets the product standard's requirements.
10.2.2.3 Verification of resistance of insulating materials to abnormal heat and fire due to internal electric effects			Meets the product standard's requirements.
10.2.4 Resistance to ultra-violet (UV) radiation			UV resistance only in connection with protective shield.
10.2.5 Lifting			Does not apply, since the entire switchgear needs to be evaluated.
10.2.6 Mechanical impact			Does not apply, since the entire switchgear needs to be evaluated.
10.2.7 Inscriptions			Meets the product standard's requirements.
10.3 Degree of protection of ASSEMBLIES			Does not apply, since the entire switchgear needs to be evaluated.
10.4 Clearances and creepage distances			Meets the product standard's requirements.
10.5 Protection against electric shock			Does not apply, since the entire switchgear needs to be evaluated.
10.6 Incorporation of switching devices and components			Does not apply, since the entire switchgear needs to be evaluated.
10.7 Internal electrical circuits and connections			Is the panel builder's responsibility.
10.8 Connections for external conductors			Is the panel builder's responsibility.
10.9 Insulation properties			
10.9.2 Power-frequency electric strength			Is the panel builder's responsibility.
10.9.3 Impulse withstand voltage			Is the panel builder's responsibility.
10.9.4 Testing of enclosures made of insulating material			Is the panel builder's responsibility.
10.10 Temperature rise			The panel builder is responsible for the temperature rise calculation. Eaton will provide heat dissipation data for the devices.
10.11 Short-circuit rating			Is the panel builder's responsibility. The specifications for the switchgear must be observed.
10.12 Electromagnetic compatibility			Is the panel builder's responsibility. The specifications for the switchgear must be observed.
10.13 Mechanical function			The device meets the requirements, provided the information in the instruction leaflet (IL) is observed.

## Technical data ETIM 7.0

Low-voltage industrial components (EG000017) / Off-load switch (EC001105)			
Electric engineering, automation, process control engineering / Low-voltage switch technology / Off-load switch, circuit breaker, control switch / Changeover switch (ecl@ss10.0.1-27-37-14-05 [AKF062013])			
Model			Reversing switch
Number of poles			3
With 0 (off) position			Yes
With retraction in 0-position			No
Rated permanent current $I_u$		A	20
Rated operation current $I_e$ at AC-3, 400 V		A	11.5
Rated operation power at AC-3, 400 V		kW	4
Degree of protection (IP), front side			IP65
Degree of protection (NEMA), front side			Other
Number of auxiliary contacts as normally closed contact			0

Number of auxiliary contacts as normally open contact		0
Number of auxiliary contacts as change-over contact		0
Suitable for ground mounting		Yes
Suitable for front mounting 4-hole		No
Suitable for distribution board installation		No
Suitable for intermediate mounting		No
Complete device in housing		Yes
Material housing		Plastic
Type of control element		Toggle
Type of electrical connection of main circuit		Screw connection

## Dimensions

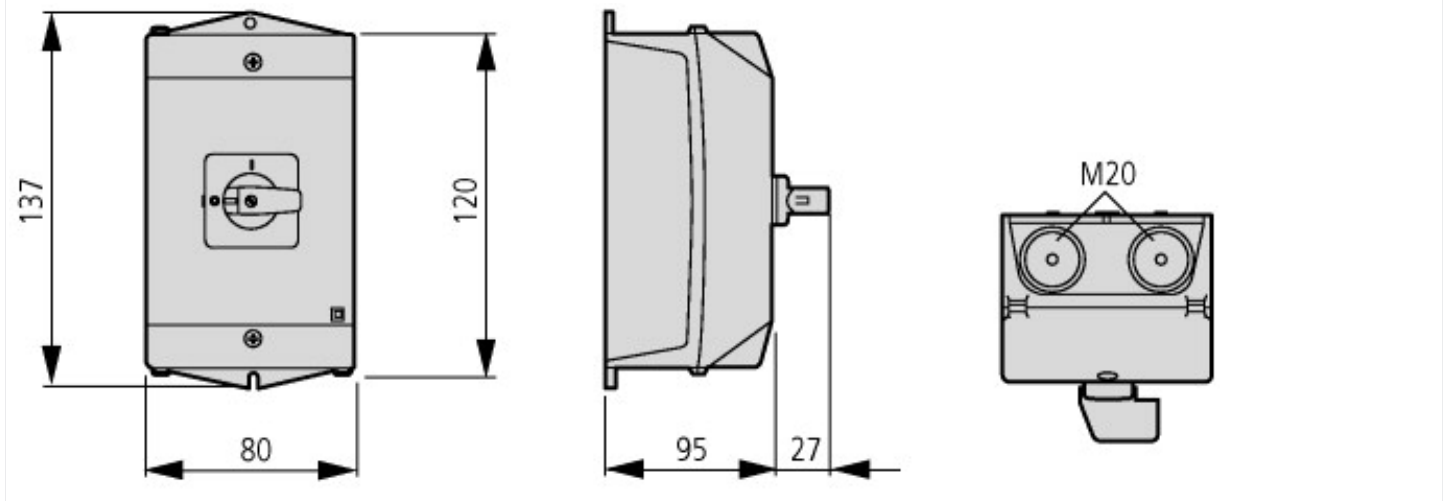

# M4



Drilling dimensions base

## Assets (links)

[Declaration of CE Conformity](#)

00003075

[Instruction Leaflets](#)

IL03801007Z2018\_05

## Additional product information (links)

**IL03801007Z (AWA1150-1687) Cam switches: surface mounting enclosure**

IL03801007Z (AWA1150-1687) Cam switches: surface mounting enclosure [ftp://ftp.moeller.net/DOCUMENTATION/AWA\\_INSTRUCTIONS/IL03801007Z2018\\_05.pdf](ftp://ftp.moeller.net/DOCUMENTATION/AWA_INSTRUCTIONS/IL03801007Z2018_05.pdf)

Display flip catalog page. <http://ecat.moeller.net/flip-cat/?edition=K115A&startpage=48>

Standard interlock SOND27, 28, 29, 30 [ftp://ftp.moeller.net/DOCUMENTATION/AWB\\_MANUALS/MZ008001ZU.pdf](ftp://ftp.moeller.net/DOCUMENTATION/AWB_MANUALS/MZ008001ZU.pdf)

Technical overview cam switch, switch-disconnector <http://de.ecat.moeller.net/flip-cat/?edition=HPLTEv1&startpage=4.2>

System overview cam switch T	<a href="http://de.ecat.moeller.net/flip-cat/?edition=HPLTEv1&amp;startpage=4.4">http://de.ecat.moeller.net/flip-cat/?edition=HPLTEv1&amp;startpage=4.4</a>
System overview switch-disconnector P	<a href="http://de.ecat.moeller.net/flip-cat/?edition=HPLTEv1&amp;startpage=4.6">http://de.ecat.moeller.net/flip-cat/?edition=HPLTEv1&amp;startpage=4.6</a>
Key to part numbers Cam switch	<a href="http://de.ecat.moeller.net/flip-cat/?edition=HPLTEv1&amp;startpage=4.8">http://de.ecat.moeller.net/flip-cat/?edition=HPLTEv1&amp;startpage=4.8</a>
Key to part numbers Switch-disconnector	<a href="http://de.ecat.moeller.net/flip-cat/?edition=HPLTEv1&amp;startpage=4.8">http://de.ecat.moeller.net/flip-cat/?edition=HPLTEv1&amp;startpage=4.8</a>
Switches for ATEX	<a href="http://www.coopercrouse-hinds.eu/en/products/25-ex-safety-and-main-current-switches.html">http://www.coopercrouse-hinds.eu/en/products/25-ex-safety-and-main-current-switches.html</a>
Ordering form for SOND switches and SOND front plates(DE_EN)	<a href="ftp://ftp.moeller.net/DOCUMENTATION/PDF/MZ008005ZU_Orderform_Customized_Switch.pdf">ftp://ftp.moeller.net/DOCUMENTATION/PDF/MZ008005ZU_Orderform_Customized_Switch.pdf</a>
Ordering form for SOND switches and SOND front plates(DE_EN)	<a href="ftp://ftp.moeller.net/DOCUMENTATION/PDF/MZ008006ZU_Orderform_Customized_Switch.pdf">ftp://ftp.moeller.net/DOCUMENTATION/PDF/MZ008006ZU_Orderform_Customized_Switch.pdf</a>