



**Switch-disconnector 4p 200A 1500VDC**

**Part no.** N2-4-200-S15-DC  
**Catalog No.** 167689  
**Alternate Catalog No.** N2-4-200-S15-DC



Similar to illustration

**Delivery program**

Product range			Switch-disconnectors
Protective function			Disconnectors/main switches Photovoltaic applications
Product range			DC switch-disconnectors
Application field			Utility buildings Open areas
Part no.			N...DC
Standard/Approval			IEC
Rated operational voltage			1500
Installation type			Fixed
Construction size			N2
Description			IEC/EN 60947-3 CCC China Compulsory Certificate Main switch characteristics including positive drive to IEC/EN 60204 and VDE 0113. Isolating characteristics to IEC/EN 60947-3 and VDE 0660. N switch-disconnectors can, in addition, be combined with NZM...-XU, NZM...-XA shunt releases and auxiliary contacts as well as with NZM...-XR... remote operator. For DC switching, all 4 contacts must be connected in series. Refer to the information on jumper kit accessories. Supplied as standard: Screw connection; box terminal optional. When working with ungrounded systems (e.g., IT), the installation must ensure that a double ground fault will be impossible. Switch can not be combined with plug-in/withdrawable units and/or connection on rear.
Connection options			
Number of poles			4-pole basic device, usable in a 1-pole or 2-pole configuration depending on the type of connection
Standard equipment			Screw connection
Switch positions			I, +, 0
Rated current = rated uninterrupted current	$I_n = I_u$	A	200
Remotely control / trip			Remote operation with shunt releases / remote operator
Rated operating frequency			DC

## Technical data

### Switch-disconnectors

Rated operational voltage, max.	U <sub>e</sub>	V DC	1500
Rated uninterrupted current with terminal jumpers			
at 40°			200
at 65°			200
			Values for rated uninterrupted current at 65 °C include jumpers.
Utilization category			DC-22A
Rated operational current	I <sub>e</sub>	A	
DC 22-A	I <sub>e</sub>	A	200
Overvoltage category/pollution degree			III/2
Rated insulation voltage	U <sub>i</sub>	V	1500
Ambient temperature			
Ambient temperature, storage		°C	- 40 - + 70
Operation		°C	-25 - +70

### Rated short-time withstand current

t = 1 s	I <sub>cw</sub>	kA	3.6
---------	-----------------	----	-----

### Lifespan, mechanical

Max. operating frequency		Ops/h	120
Lifespan, mechanical	Operations		20000
			Lifespan, mechanical: of which max. 50 % trip by shunt/undervoltage release

### Terminal capacity

Standard equipment			Screw connection
Round copper conductor			
Box terminal			
Solid		mm <sup>2</sup>	1 x (4 - 16) 2 x (4 - 16)
Stranded		mm <sup>2</sup>	1 x (25 - 185) 2 x (25 - 70)
Tunnel terminal			
Solid		mm <sup>2</sup>	1 x 16
Stranded			
Stranded		mm <sup>2</sup>	1 x (25 - 185)
Bolt terminals			
Direct on the switch			
Solid		mm <sup>2</sup>	1 x (10 - 16) 2 x (4 - 16)
Stranded		mm <sup>2</sup>	1 x (25 - 185) 2 x (25 - 70)
Al conductors, Cu cable			
Tunnel terminal			
Solid		mm <sup>2</sup>	1 x 16
Stranded			
Stranded		mm <sup>2</sup>	1 x (25 - 185)
Bolt terminal and rear-side connection			
Flat copper strip, with holes	min.	mm	2 x 16 x 0.8
Flat copper strip, with holes	max.	mm	10 x 24 x 0.8
Cu strip (number of segments x width x segment thickness)			
Box terminal			
	min.	mm	2 x 9 x 0,8
	max.	mm	10 x 16 x 0,8 (2 x) 8 x 15,5 x 0,8
Bolt terminal and rear-side connection			
Flat copper strip, with holes	min.	mm	2 x 16 x 0.8
Flat copper strip, with holes	max.	mm	10 x 24 x 0.8
Copper busbar (width x thickness)	mm		
Bolt terminal and rear-side connection			

Screw connection			M8
Direct on the switch			
	min.	mm	16 x 5
	max.	mm	24 x 8

## Design verification as per IEC/EN 61439

Technical data for design verification			
Rated operational current for specified heat dissipation	$I_n$	A	200
Equipment heat dissipation, current-dependent	$P_{vid}$	W	42
Operating ambient temperature min.		°C	-25
Operating ambient temperature max.		°C	70
IEC/EN 61439 design verification			
10.2 Strength of materials and parts			
10.2.2 Corrosion resistance			Meets the product standard's requirements.
10.2.3.1 Verification of thermal stability of enclosures			Meets the product standard's requirements.
10.2.3.2 Verification of resistance of insulating materials to normal heat			Meets the product standard's requirements.
10.2.3.3 Verification of resistance of insulating materials to abnormal heat and fire due to internal electric effects			Meets the product standard's requirements.
10.2.4 Resistance to ultra-violet (UV) radiation			Meets the product standard's requirements.
10.2.5 Lifting			Does not apply, since the entire switchgear needs to be evaluated.
10.2.6 Mechanical impact			Does not apply, since the entire switchgear needs to be evaluated.
10.2.7 Inscriptions			Meets the product standard's requirements.
10.3 Degree of protection of ASSEMBLIES			Does not apply, since the entire switchgear needs to be evaluated.
10.4 Clearances and creepage distances			Meets the product standard's requirements.
10.5 Protection against electric shock			Does not apply, since the entire switchgear needs to be evaluated.
10.6 Incorporation of switching devices and components			Does not apply, since the entire switchgear needs to be evaluated.
10.7 Internal electrical circuits and connections			Is the panel builder's responsibility.
10.8 Connections for external conductors			Is the panel builder's responsibility.
10.9 Insulation properties			
10.9.2 Power-frequency electric strength			Is the panel builder's responsibility.
10.9.3 Impulse withstand voltage			Is the panel builder's responsibility.
10.9.4 Testing of enclosures made of insulating material			Is the panel builder's responsibility.
10.10 Temperature rise			The panel builder is responsible for the temperature rise calculation. Eaton will provide heat dissipation data for the devices.
10.11 Short-circuit rating			Is the panel builder's responsibility. The specifications for the switchgear must be observed.
10.12 Electromagnetic compatibility			Is the panel builder's responsibility. The specifications for the switchgear must be observed.
10.13 Mechanical function			The device meets the requirements, provided the information in the instruction leaflet (IL) is observed.

## Technical data ETIM 7.0

Low-voltage industrial components (EG000017) / Switch disconnecter (EC000216)			
Electric engineering, automation, process control engineering / Low-voltage switch technology / Off-load switch, circuit breaker, control switch / Switch disconnecter (ecl@ss10.0.1-27-37-14-03 [AKF060013])			
Version as main switch			Yes
Version as maintenance-/service switch			Yes
Version as safety switch			No
Version as emergency stop installation			Yes
Version as reversing switch			No
Number of switches			1
Max. rated operation voltage $U_e$ AC		V	0
Rated operating voltage		V	1500 - 1500
Rated permanent current $I_u$		A	200
Rated permanent current at AC-23, 400 V		A	0
Rated permanent current at AC-21, 400 V		A	0
Rated operation power at AC-3, 400 V		kW	0

Rated short-time withstand current I <sub>cs</sub>	kA	3.6
Rated operation power at AC-23, 400 V	kW	0
Switching power at 400 V	kW	0
Conditioned rated short-circuit current I <sub>c</sub>	kA	0
Number of poles		4
Number of auxiliary contacts as normally closed contact		0
Number of auxiliary contacts as normally open contact		0
Number of auxiliary contacts as change-over contact		0
Motor drive optional		Yes
Motor drive integrated		No
Voltage release optional		Yes
Device construction		Built-in device fixed built-in technique
Suitable for ground mounting		Yes
Suitable for front mounting 4-hole		No
Suitable for front mounting centre		No
Suitable for distribution board installation		Yes
Suitable for intermediate mounting		Yes
Colour control element		Black
Type of control element		Rocker lever
Interlockable		Yes
Type of electrical connection of main circuit		Screw connection
Degree of protection (IP), front side		IP20
Degree of protection (NEMA)		

## Dimensions

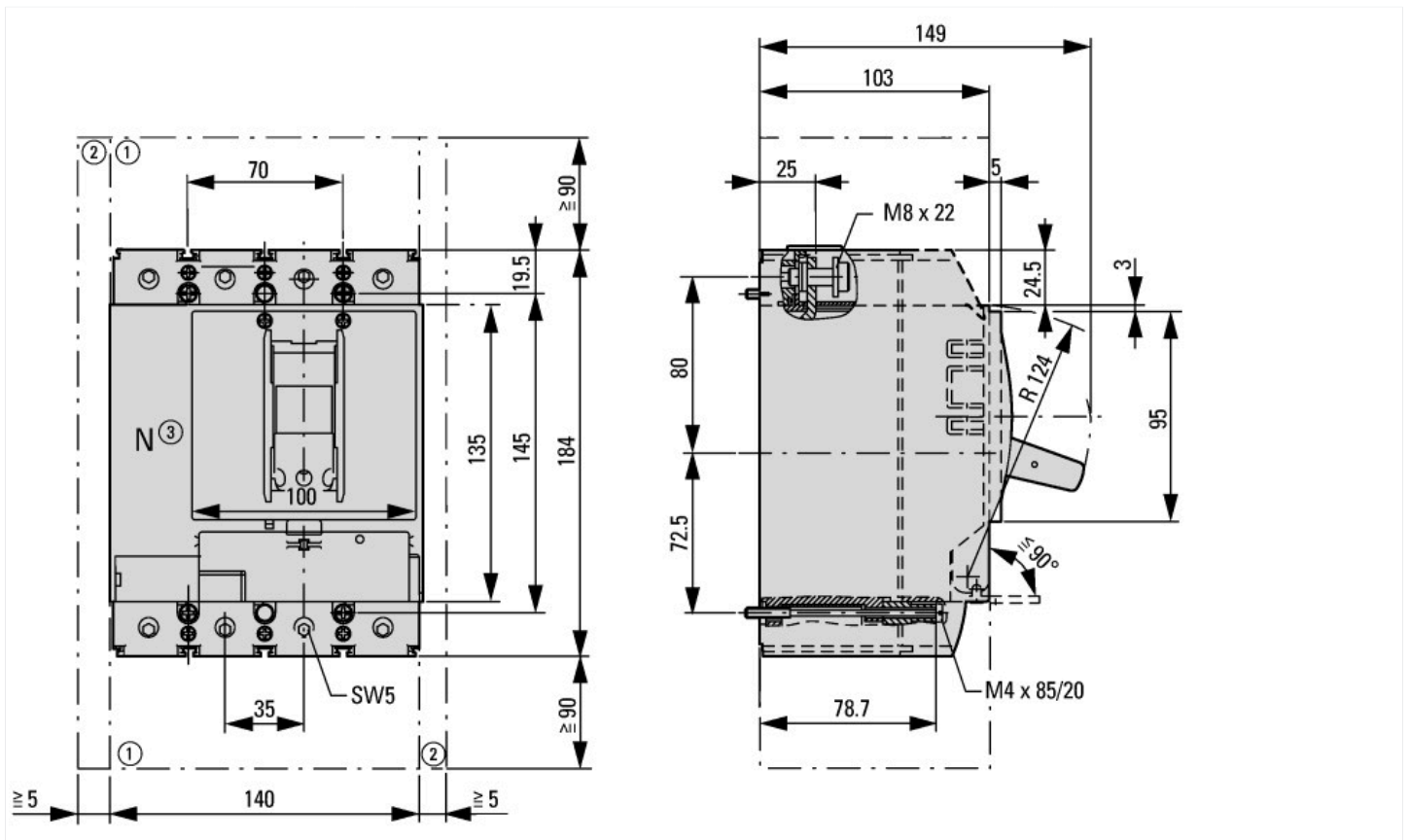

- ① Blow out area, minimum clearance to other parts  $\geq 90$  mm
- ② Minimum clearance to adjacent parts  $\geq 5$  mm
- ③ Does not apply to DC applications

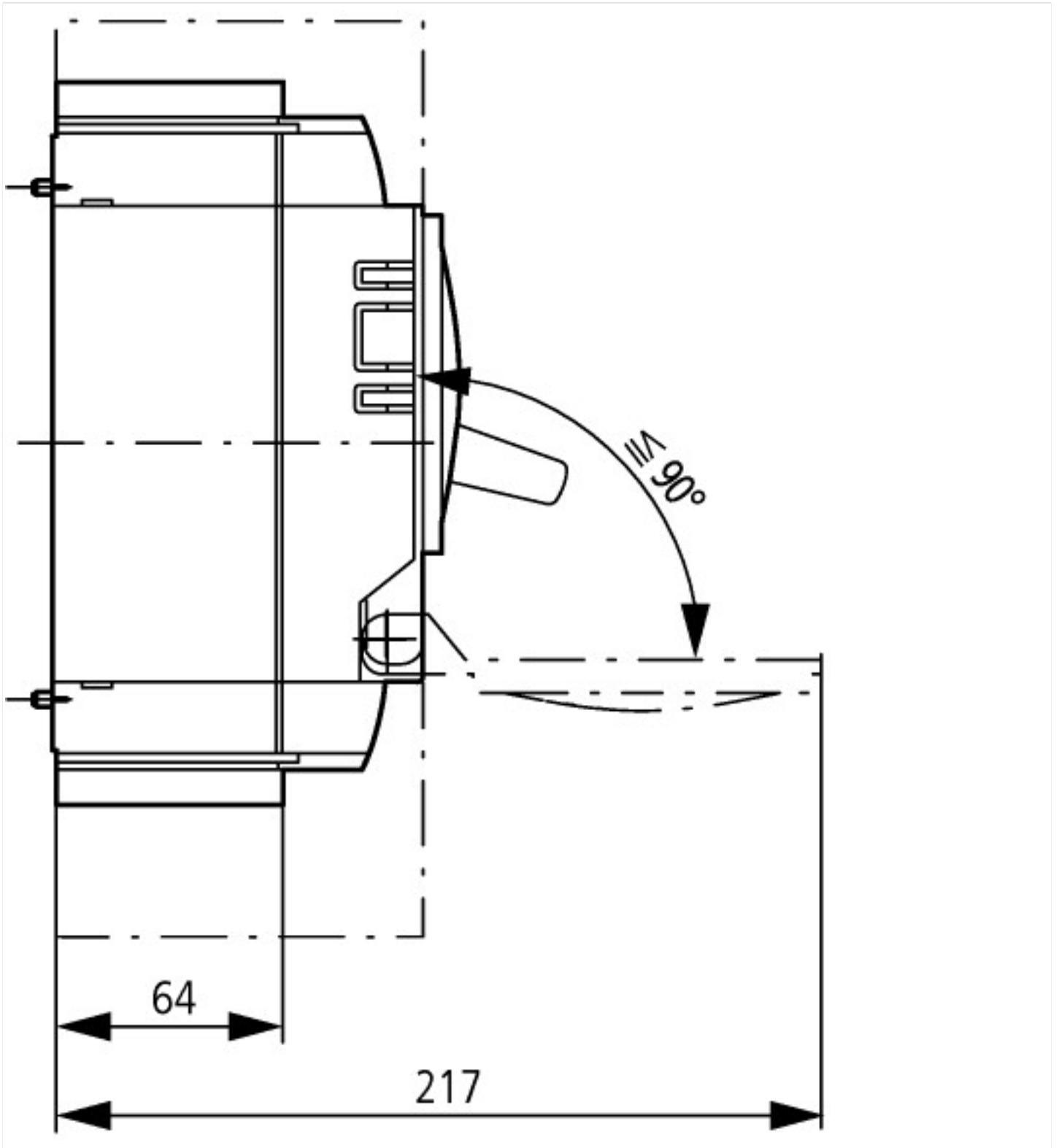

### Additional product information (links)

CurveSelect characteristics program	<a href="http://www.eaton.eu/DE/Europe/Electrical/CustomersSupport/ConfigurationTools/CharacteristicsProgram/index.htm">http://www.eaton.eu/DE/Europe/Electrical/CustomersSupport/ConfigurationTools/CharacteristicsProgram/index.htm</a>
Eaton configurator	<a href="http://www.eaton.eu/DE/Europe/Electrical/CustomersSupport/ConfigurationTools/ConfiguratorCircuitBreaker/index.htm">http://www.eaton.eu/DE/Europe/Electrical/CustomersSupport/ConfigurationTools/ConfiguratorCircuitBreaker/index.htm</a>
Additional technical data: Photovoltaics catalog (starting on page 35)	<a href="http://www.moeller.net/binary/pdf_kat/br01601001z_en.pdf">http://www.moeller.net/binary/pdf_kat/br01601001z_en.pdf</a>