

**Side mounted handle, kit, type 4X 48z, size 3, UL**

**Part no.** NZM3-XSH-4X-48-NA  
**Catalog No.** 155501  
**Alternate Catalog No.** NZM3-XSH-4X-48-NA

**Delivery program**

Product range		Accessories
Accessories		side mounted handle
Standard/Approval		UL/CSA (keine Zulassung im Geltungsbereich der IEC/EN 60947)
Construction size		NZM3
Description		For mounting outside the control panel door Used to operate a switch with a toggle lever using a Bowden cable and a mechanical system that needs to be mounted on the front end of the switch. For switch with toggle lever
Equipment supplied		Complete kit Includes handle, mechanical system, and Bowden cable
Function		For 1 door on an American-style control panel (door plus wide bar next to door)
Protection class		UL/CSA Type 4X
Door interlock		Lockable in the 0 position using up to 3 padlocks on the handle
For use with		NZM3...-NA, NS3...-NA
<b>Notes</b>		
Caution! Intended exclusively for use outside the scope of application of IEC/EN 60947!		

**Design verification as per IEC/EN 61439**

IEC/EN 61439 design verification		
10.2 Strength of materials and parts		
10.2.2 Corrosion resistance		Meets the product standard's requirements.
10.2.3.1 Verification of thermal stability of enclosures		Meets the product standard's requirements.
10.2.3.2 Verification of resistance of insulating materials to normal heat		Meets the product standard's requirements.
10.2.3.3 Verification of resistance of insulating materials to abnormal heat and fire due to internal electric effects		Meets the product standard's requirements.
10.2.4 Resistance to ultra-violet (UV) radiation		Meets the product standard's requirements.
10.2.5 Lifting		Does not apply, since the entire switchgear needs to be evaluated.
10.2.6 Mechanical impact		Does not apply, since the entire switchgear needs to be evaluated.
10.2.7 Inscriptions		Meets the product standard's requirements.
10.3 Degree of protection of ASSEMBLIES		Does not apply, since the entire switchgear needs to be evaluated.
10.4 Clearances and creepage distances		Meets the product standard's requirements.
10.5 Protection against electric shock		Does not apply, since the entire switchgear needs to be evaluated.
10.6 Incorporation of switching devices and components		Does not apply, since the entire switchgear needs to be evaluated.
10.7 Internal electrical circuits and connections		Is the panel builder's responsibility.
10.8 Connections for external conductors		Is the panel builder's responsibility.
10.9 Insulation properties		
10.9.2 Power-frequency electric strength		Is the panel builder's responsibility.
10.9.3 Impulse withstand voltage		Is the panel builder's responsibility.
10.9.4 Testing of enclosures made of insulating material		Is the panel builder's responsibility.
10.10 Temperature rise		The panel builder is responsible for the temperature rise calculation. Eaton will provide heat dissipation data for the devices.
10.11 Short-circuit rating		Is the panel builder's responsibility. The specifications for the switchgear must be observed.
10.12 Electromagnetic compatibility		Is the panel builder's responsibility. The specifications for the switchgear must be observed.
10.13 Mechanical function		The device meets the requirements, provided the information in the instruction leaflet (IL) is observed.

**Technical data ETIM 7.0**

Lockable		Yes
Colour		Black
Suitable for emergency stop		No
With extension shaft		Yes
Suitable for power circuit breaker		Yes
Suitable for switch disconnecter		Yes

## Dimensions

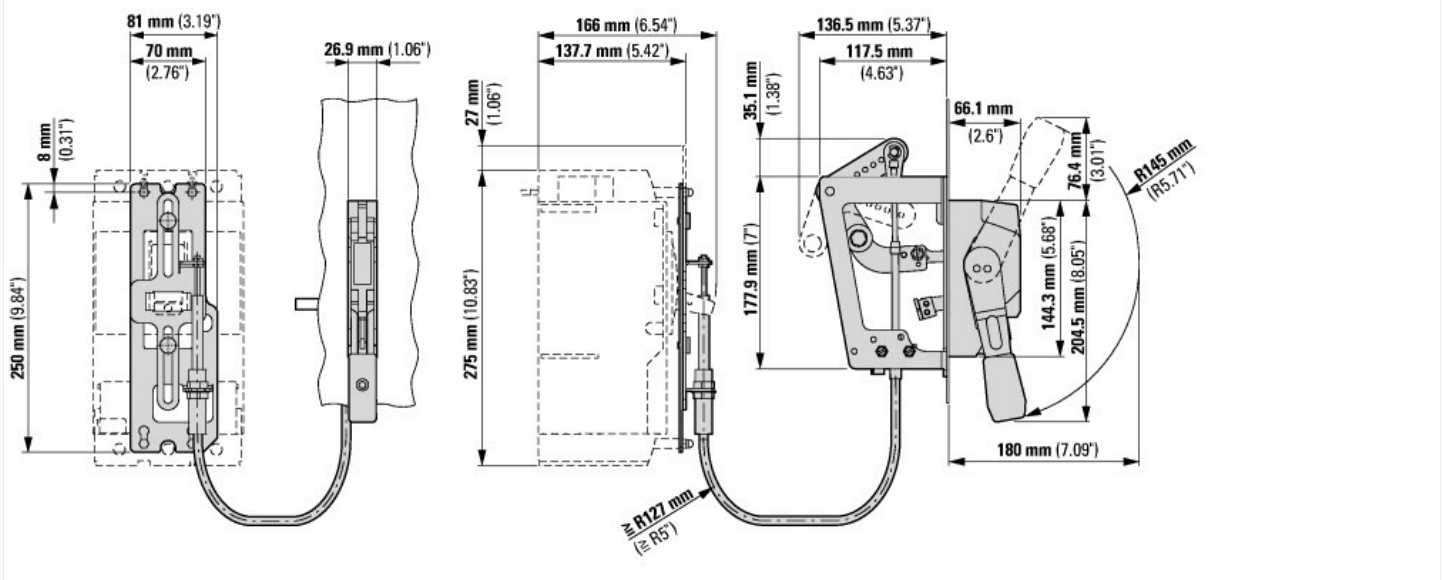

Flange mounted handle kit Type 4X 48°