



Main switch, +steel enclosure, 3p, 32A, handle red yellow, lockable

Part no. P1-32/ST/SVB
Catalog No. 025522

Similar to illustration

Dimensions

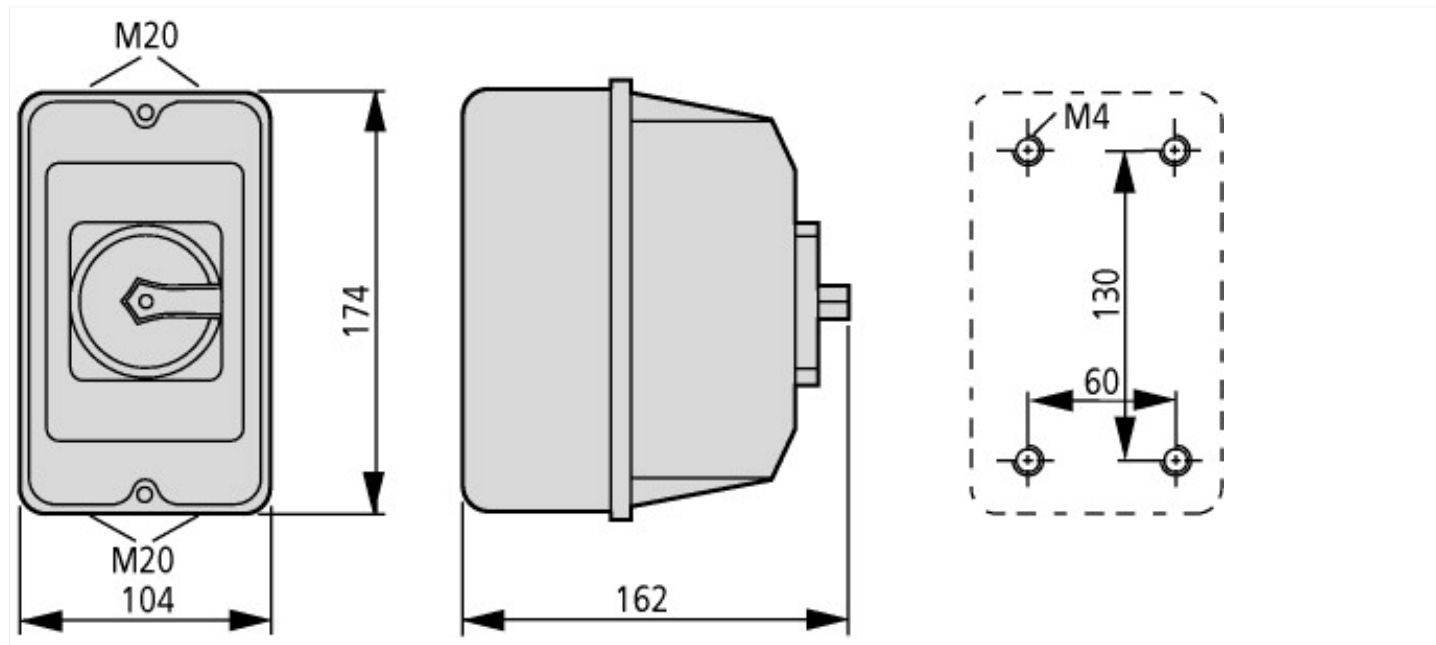

Assets (links)

Declaration of CE Conformity

00003102

Instruction Leaflets

IL03802007Z2018_05