

Overview Brochure | ADAP-KOOL® Pack Controllers

Smart, reliable and efficient pack controllers, based on Danfoss expertise, and for expanding opportunities



ADAP-KOOL® pack controllers ensure accurate control and operational reliability for advanced solutions

Danfoss offers a range of pack controllers for use in compact systems, as well as in large power packs. The ADAP-KOOL® pack controllers ensure efficient control and operational reliability for advanced solutions for controlling up to 22 compressors. The intelligent controllers optimize the suction and condensing pressure according to load and outdoor temperatures. Additional energy savings and low maintenance costs can be achieved by using variable speed control of condenser fans and compressors and other advanced features such as suction pressure optimization, self-diagnosis and automatic fault detection. The AK-ST 500 provide a good diagnostic tool for remote management.

Features and benefits:

- Full range of compressor and condenser controllers for small and large food retail applications
- Accurate control and great reliability for high energy efficiency and low maintenance costs
- Leading control technology for the Multi Ejector Solution™
- Heat recovery for tap water and space heating
- Remote management

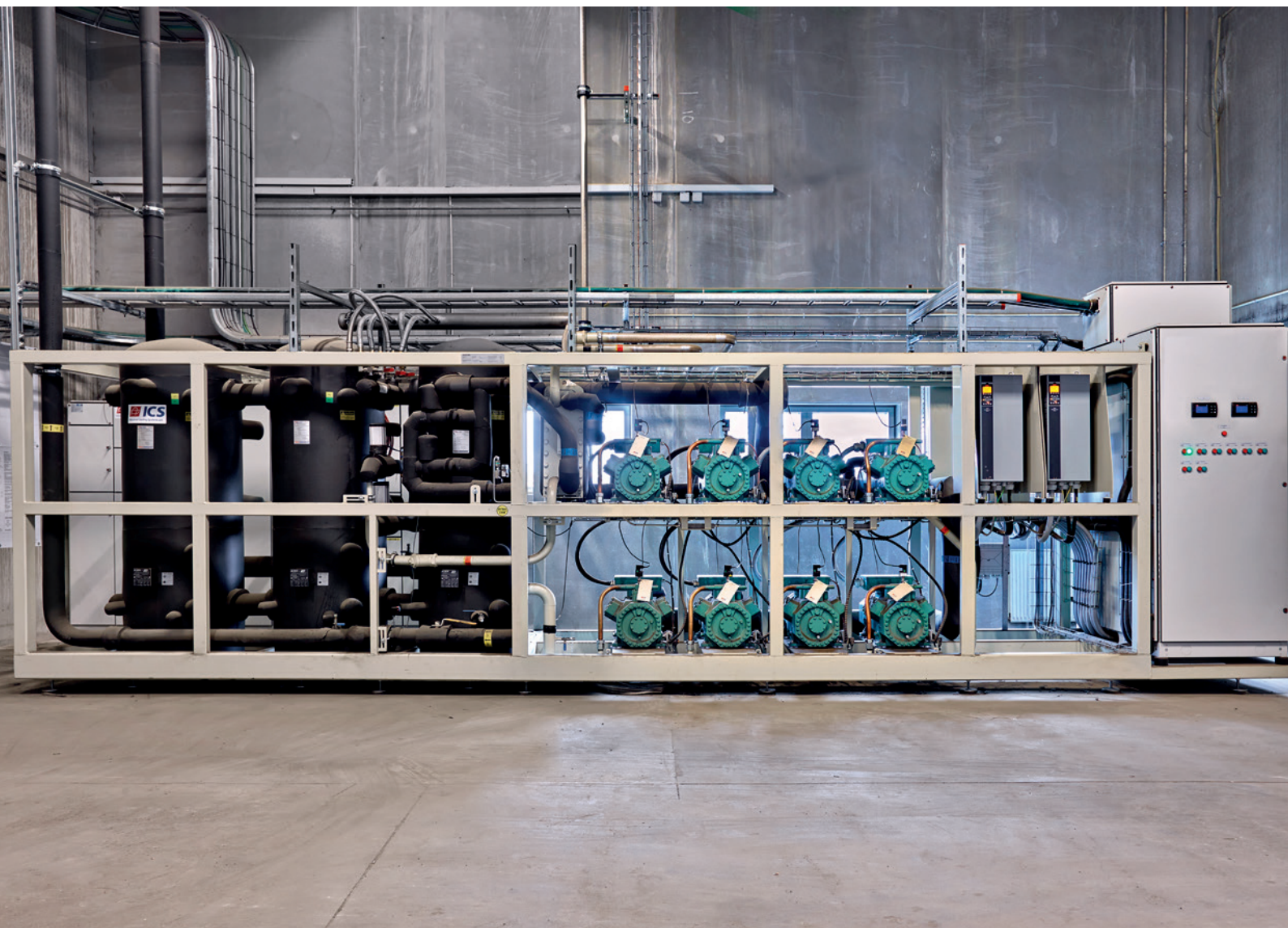

Pack Controller **product portfolio**

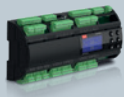
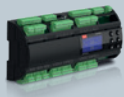
									
	AK-PC 351 Small Pack Controller	AK-PC 551 Medium Pack Controller	AK-PC 572 MiniPack Controller	AK-PC 651A Large Pack Controller	AK-PC 772A Transcritical CO ₂ Mini-Booster Controller	AK-PC 781A Multi purpose HFC or CO ₂ Pack Controller	AK-PC 782A Transcritical CO ₂ Booster Pack controller	AK-PC 782B Transcritical CO ₂ Booster Pack controller	AK-PC 783A HFC/CO ₂ Cascade Controller
Application	Single Suction Condenser	Dual Suction Condenser	CO ₂ MiniPack Controller	Single Suction Condenser	Transcritical Mini Booster	Universal Pack ¹⁾	Booster Transcritical	Booster Transcritical	Cascade Condenser
HFC	✓	✓	-	✓	-	✓	-	-	✓
CO ₂	-	-	✓	-	✓	✓	✓	✓	✓
Suction Groups									
No. of suction groups	1	2	2	1	3	1	3	3	2
No. of compressors	4	8 / 4+4	3+2	10	3 (MT+IT) + 2	10	18 (MT+IT) + 4	18 (MT+IT) + 4	4+4 / 5+3
Compressor control	Variable + step	Variable + step	Variable + step	Variable + step	Variable + step	Variable + step	Variable + step	Variable + step	Variable + step
Control sensor	P/T	P/T	P	P/T	P	P/T	P	P	P/T
Cascade injection control	-	-	-	-	-	-	-	-	✓
Condenser									
Fan control	Step or Speed	Step or Speed	Speed	Step or Speed	Step and/or Speed	Step and/or Speed	Step and/or Speed	Step and/or Speed	Step and/or Speed
No. of steps	4	8	-	8	4	8	8	8	8
Control sensor	P/T	P/T	P/T	P/T	P/T	P/T	P/T	P/T	P/T
CO ₂ high pressure valve and receiver control	-	-	✓	-	✓	✓	✓	✓	-
Heat recovery	-	Standard	Standard	Standard	Standard	Advanced	Advanced	Advanced	Standard
Data Communication									
Protocol	Modbus	Modbus	Modbus	Modbus	LON	LON	LON	IP	LON
Front-end support	AK-SM 8xxA ²⁾	AK-SM 8xxA ²⁾	AK-SM 8xxA	AK-SM 8xxA ²⁾	AK-SM 8xxA AK-SM 350/ 720 ³⁾	AK-SM 8xxA AK-SM 350/ 720 ³⁾	AK-SM 8xxA AK-SM 350/ 720	AK-SM 8xxA ⁴⁾	AK-SM 8xxA AK-SM 350/ 720 ³⁾
No. of digital outputs	6	8	10	15	Flexible via I/O	Flexible via I/O	Flexible via I/O	Flexible via I/O	Flexible via I/O
Total number of IO	20	27	35	47	120	120	220	220	160
Graphical display	Built in	Built in/ External	Built in/ External	Built in/ External	External	External	External	External	External

¹⁾ AK-PC 781A can be used in a hybrid CO₂ cascade solution by using 2x AK-PC 781A and and EKE1A/B/C for the cascade

AK-PC 781A can be used in a transcritical CO₂ booster application by using 2x AK-PC 781A or 3x AK-PC 781A

²⁾ Limited support for selected legacy front ends (AK-SC 355)

³⁾ Limited support for selected legacy front ends (AKA245, AK-SC 255, AK-SC 355)

⁴⁾ All System Managers AK-SM 8xxA with SW Ver. 3.1 and onwards

Mid-end Pack Controllers

AK-PC 351 • AK-PC 551 • AK-PC 572 • AK-PC 651A

The mid-end pack controller range is very compact and available in different sizes optimized for small, medium and large pack. Despite the small form factor, the product range offers advanced features:

- 4, 5, 8 or 10 compressor outputs
- Optimized factory settings and control algorithms for HFC and CO₂ packs
- Energy saving features
- Graphical user interface with Wizard Setup
- ADAP-KOOL® system integration



AK-PC 572 MiniPack – CO₂ made easy

The new AK-PC 572 MiniPack controller provides a complete pack solution for small store retailers wanting to benefit from using CO₂ as a refrigerant. While compact and cost-effective, it includes much of the technology contained with the AK-PC781A pack controller – a product known for over a decade of proven reliability in CO₂ applications. The AK-PC 572 MiniPack also makes the use of CO₂ much more approachable, even for those who have little-to-no experience with CO₂. It contains all the essential functionality of a dedicated CO₂ controller, but with unique ease of use and minimal complexity.

Features and benefits:

- Full CO₂ booster solution with up to 5 compressors
- Reduced operational costs with proven technology from flexible pack controllers
- CO₂ made easy, requiring little CO₂ knowhow and offering efficient interfaces for OEM's as well as installers
- Cost effective hardware solution based on a compact design requiring limited space in the electrical panel
- Ease of use with few parameter settings, wizard based set-up and graphical daily use screens
- Integrated pack design supporting multiple compressor technologies and simple interfaces to external systems like heating
- Flexible solution with optional features like heat recovery, oil management, liquid injection, de-superheater, hot gas dump etc.

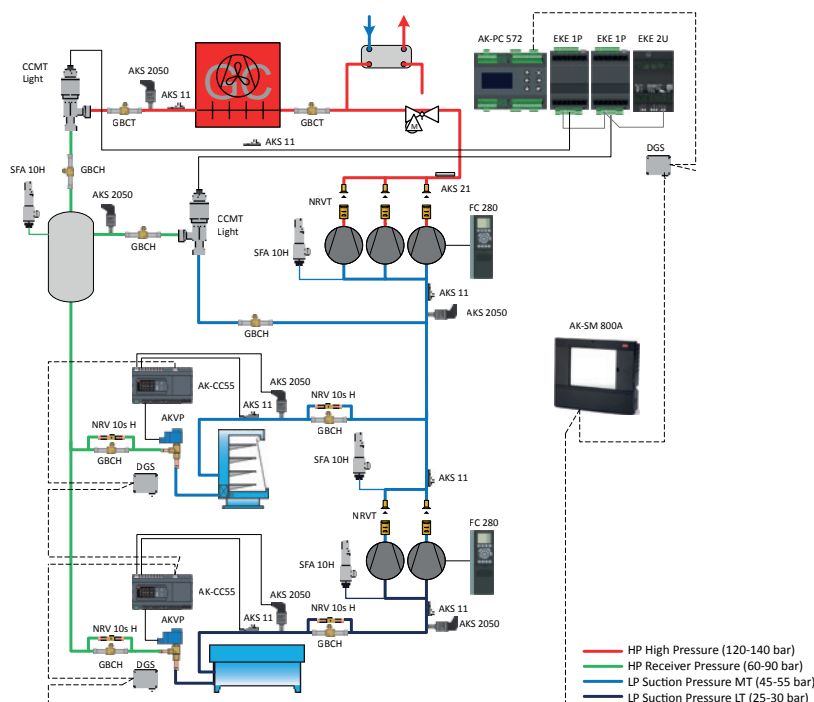

High-end Pack Controllers

AK-PC 772A • AK-PC 781A • AK-PC 782A/B • AK-PC 783A

The flexible pack controller range is scalable and offers high customization both in terms of the pack design as well as control algorithms. The high-end pack controllers offer highest safety and efficiency with:

- Up to 22 compressor outputs
- Controls HFC systems, HFC/CO₂ cascades or CO₂ transcritical systems
- Parallel compressor support
- Enables Multi Ejector Solution™ and CALM™
- Advanced Heat Recovery
- High pressure CO₂ and receiver valve control
- Setpoint Management function



AK-PC 782B for integrated and optimized CO₂ pack control

The AK-PC 782B is designed for integrated pack control in transcritical CO₂ booster packs and offers precise regulation, improved efficiency and enhanced user-friendliness. Handling up to 3 suction groups, AK-PC 782B performs all necessary control functions as one, integrated solution. The integrated control leads to precise regulation and high efficiency even in challenging operational conditions. The highest possible flexibility matching the specific application needs is achieved by adding IO-modules to the pack controller.

Features and benefits:

- Scalable to control large booster packs with up to 22 compressors
- Handles mixed compressor sizes and speed control of 2 compressors per suction group
- Robust algorithms ensure safe initial start-up and reliable operation
- Setpoint Management function for easier setup and more control on floating references
- World class refrigeration system efficiency with Danfoss Multi Ejector Solution™
- Receiver pressure and suction pressure optimization for maximum utilization of all compressor groups
- Gas Cooler control for maximum efficiency at all times (summer, winter, heat recovery etc.)
- General functions like thermostats and PI controllers are available for auxiliary application control
- Remote communication towards AK-SM 8xxA over IP

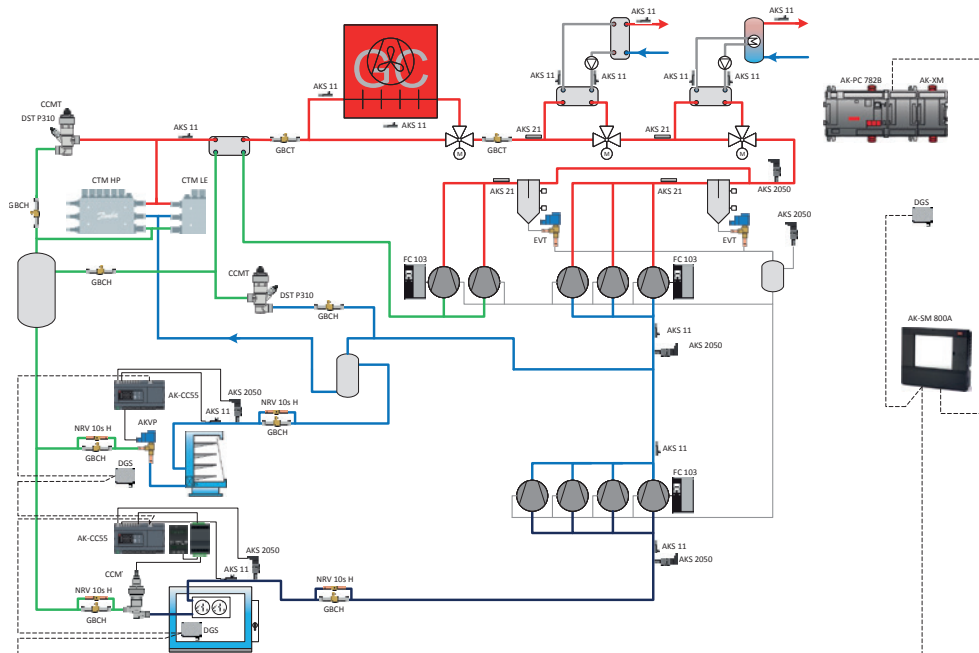

Efficient and user-friendly interfaces



Graphical control panel (MMIGRS2) for ease of service and maintenance:

Pack controllers benefit from an optional graphical display, available for both panel and wall mounting. Used for both service and commissioning purposes, it offers the following features:

- Full graphic LCD display for intuitive navigation
- Easy connection to pack controller through plug connection
- Panel (IP64) or wall mount
- Status information and parameter access in local language
 - Daily use screens with graphical representation of the application
 - 3 password protected user levels

PC based tools for fast pack set-up and configuration

Separate tools are available for the Mid-end and the High-end pack controllers, offering safe and efficient programming and analysis of the pack controller. The tools, which can be downloaded at no cost, include the following features:

- Full configuration of the pack, with access to all the parameters
- General overview of the pack and operational status in real-time
- Multi language support
- Offline preparation of backup files and online operation
- Manual control, test and calibration of inputs and outputs
- Backup and download of the configured settings
- General purpose I/O, useful for creating customized logic and applications

Read more about AK-ST 500 software application tool



AK-PT 50 for Mid-end Pack Controllers

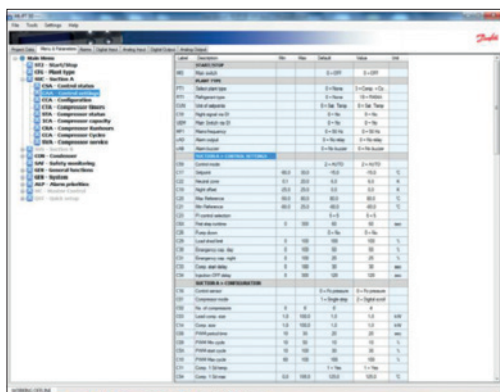

Read more about AK-PT 50 software application tool

AK-ST 500 for High-end Pack Controllers

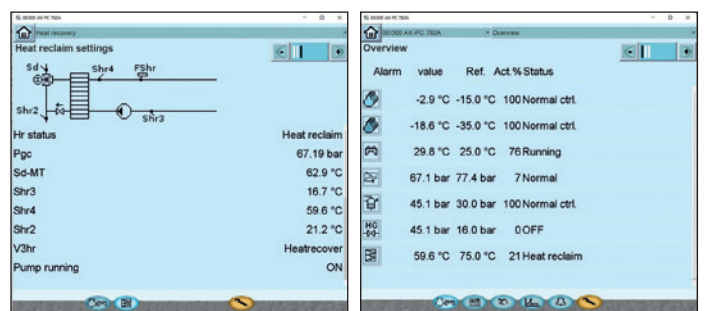

Intelligent and adaptive control in transcritical CO₂ refrigeration

Intelligent control solutions are important for achieving reliable, optimized operation and realizing financial savings and environmental benefits in your transcritical CO₂ refrigeration solution. Using controllers that constantly monitor system status and respond intelligently to condition changes is crucial. Danfoss has long been the industry standard for CO₂ pack and case controllers, and we are continuously updating our offering with new software that allows them to control and optimize CO₂ refrigeration solutions.



Read the full article here

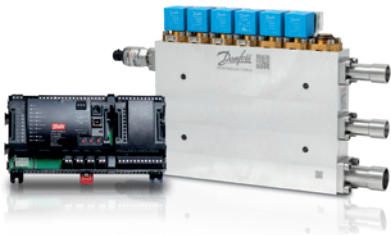

Learn more about the Multi Ejector Solution™

The Danfoss Multi Ejector Solution™ takes CO₂ to a higher level

Danfoss offers a complete portfolio of gas and liquid ejectors that provide significant benefits in CO₂ refrigeration applications.

The portfolio include:

- the Multi Ejector Low Pressure (LP)
- the Multi Ejector High Pressure (HP)
- the Liquid Ejector (LE)
- the Combi Ejector (HP/LE)























All 4 types - and 14 models to choose from ejector products are available as a complete Multi Ejector Solution™ where the ejector is controlled with the AK-PC 782B pack controller to provide the robust system controls necessary for efficient and reliable operation. The Ejector Solution™ has moved CO₂ technology into warm climates as well as improving efficiency in cold climates. In summary the Multi Ejector portfolio increases system performance for all store sizes, CO₂ systems and climates.

CO₂ Adaptive Liquid Management™ (CALM)

The new CO₂ Adaptive Liquid Management (CALM) solution allows full use of the evaporator surface in display cases and cold rooms, improving energy savings with CO₂ refrigeration in any store. CALM is a complete solution; in addition to intelligent pack and case controllers and a system manager, it includes two ground-breaking Danfoss innovations: The Liquid Ejector and the Adaptive Liquid Controls (ALC) case controller algorithm.

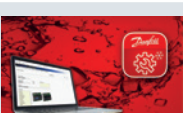

Read more about CO₂ Adaptive Liquid Management

	<p>AK-PC 351 is used for capacity control of compressors and condensers in small sized HFC refrigeration systems and covers applications with one suction group and a condenser.</p>	
	<p>AK-PC 551 is used for capacity control of compressors and condensers in medium sized HFC refrigeration systems and covers applications with one or two suction groups and a condenser.</p>	
	<p>AK-PC 572 is a complete regulating unit for capacity control of compressors and gas cooler in a small CO₂ booster systems.</p>	
	<p>The AK-PC 651A controller is used for capacity regulation of compressors and condensers in small sized HFC refrigeration applications. A maximum of 10 compressors and one condenser can be regulated.</p>	
	<p>AK-PC 772A is complete regulating units for capacity control of compressors and gas cooler in a small CO₂ booster systems.</p>	
	<p>AK-PC 781A is complete regulating units for capacity control of compressors and condensers in both HFC and CO₂ refrigeration systems.</p>	
	<p>AK-PC 782A is complete regulating units for capacity control of compressors and condensers in a transcritical CO₂ booster system with parallel compressor.</p>	
	<p>AK-PC 782B is complete regulating units for capacity control of compressors and condensers in a transcritical CO₂ booster system with parallel compressor. Remote communication towards AK-SM 8xxA over IP.</p>	
	<p>AK-PC 783A is complete regulating units for capacity control of compressors and condensers in both HFC and CO₂ refrigeration plants with cascade function.</p>	
	<p>AK-ST 500 is a software application specifically designed to support ADAP-KOOL® controllers during commissioning, configuration, and service.</p>	
	<p>AK-PT 50 Service Tool. The AK-PT 50 Programming Tool enables you to program the software on AK-PC 351, AK-PC 551, AK-PC 572, AK-PCA and more to come.</p>	

Any information, including, but not limited to information on selection of product, its application or use, product design, weight, dimensions, capacity or any other technical data in product manuals, catalogues descriptions, advertisements, etc. and whether made available in writing, orally, electronically, online or via download, shall be considered informative, and is only binding if and to the extent, explicit reference is made in a quotation or order confirmation. Danfoss cannot accept any responsibility for possible errors in catalogues, brochures, videos and other material. Danfoss reserves the right to alter its products without notice. This also applies to products ordered but not delivered provided that such alterations can be made without changes to form, fit or function of the product. All trademarks in this material are property of Danfoss A/S or Danfoss group companies. Danfoss and the Danfoss logo are trademarks of Danfoss A/S. All rights reserved.