



080R9222



RS8ES602

Danfoss can accept no responsibility for possible errors in catalogues, brochures and other printed material. Danfoss reserves the right to alter its products without notice. This also applies to products already on order provided that such alternations can be made without subsequential changes being necessary in specifications already agreed.

All trademarks in this material are property of the respective companies. Danfoss and Danfoss logotype are trademarks of Danfoss A/S. All rights reserved.

RS8ES602

2015-10

24

ADAP-KOOL®





Introduction

AK Service Tool is an advanced tool for operating ADAP-KOOL® refrigeration controllers in a network. The Service Tool can be used on all EKC and AK refrigeration controllers. Some AK controllers have a plug for direct connection to the Service Tool. All controllers can be operated when they are connected to an AK System Manager. Individual controllers contain information about the presentation of settings and measured values. This information is read by the Service Tool the first time it registers a controller of this type. This information is saved in the Service Tool so that start-up is faster on subsequent occasions.

In this booklet you are given a brief explanation of the possibilities offered you by AK, both in daily use and in connection with service calls. The aim is that you are to become familiarised with screen displays and navigation principles on a general level – so we will not give you an in-depth description of individual system types or applications.

When you have read the booklet you will be able to derive full benefit of AK-ST 500 as a control and service tool in your refrigerating plant.

Please note that this booklet is a general introduction to the AK Service Tool. Each controller for a specific system will furthermore be provided with a separate manual.

Contents

Principle	3	Alarms.....	13
Prior to installation.....	4	Log function	14
How to install the programme	5	Connection to an external system	16
Before you start the programme	6	Backup.....	17
How to start the programme	7	Off line settings	18
General navigation	8	Languages.....	19
Configuration of a controller.....	10	Customer defined texts.....	20
Authorisation of users	12	Plant overview.....	21
		Update software	23

Update software

If the software in a controller requires an upgrade, use the following procedure:

1. Connect the Service Tool directly to the controller
2. Start the update function in the Service Tool - configuration
3. The update display is shown here

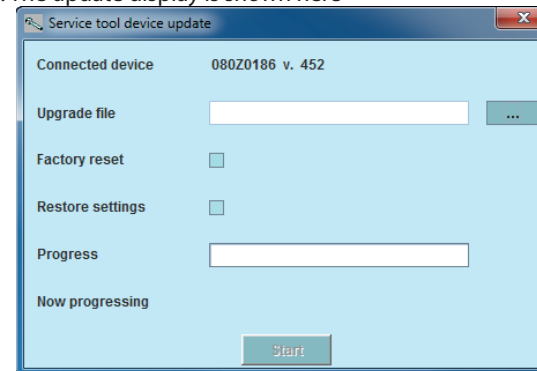

4. Find the file containing the new software
5. Tick the "Restore settings" box (after the update, the previous settings will be reused).
6. Press "Start".



3. Press "Select".

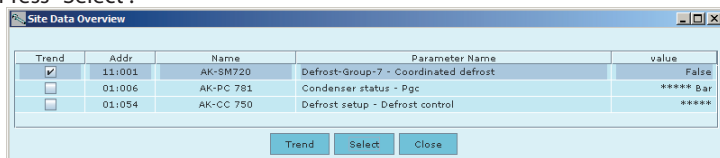

4. Select controller and parameter

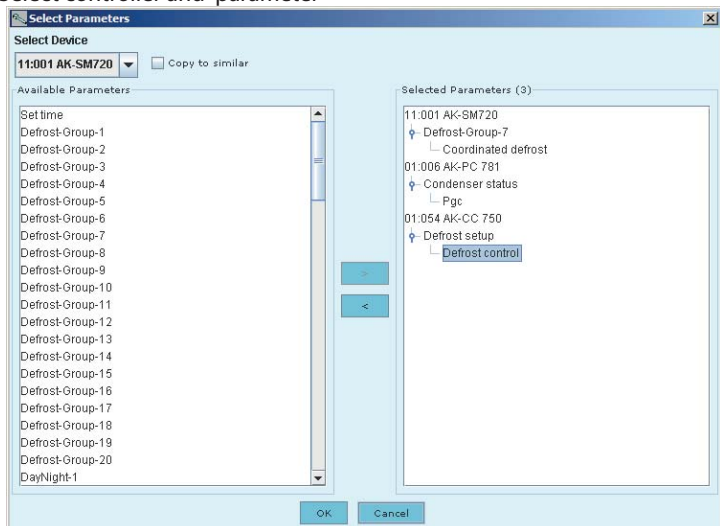

5. Finish by pressing "OK"

Principle

The AK controller is connected to the PC tool where the programme is installed. All settings are subsequently made via Windows menus.

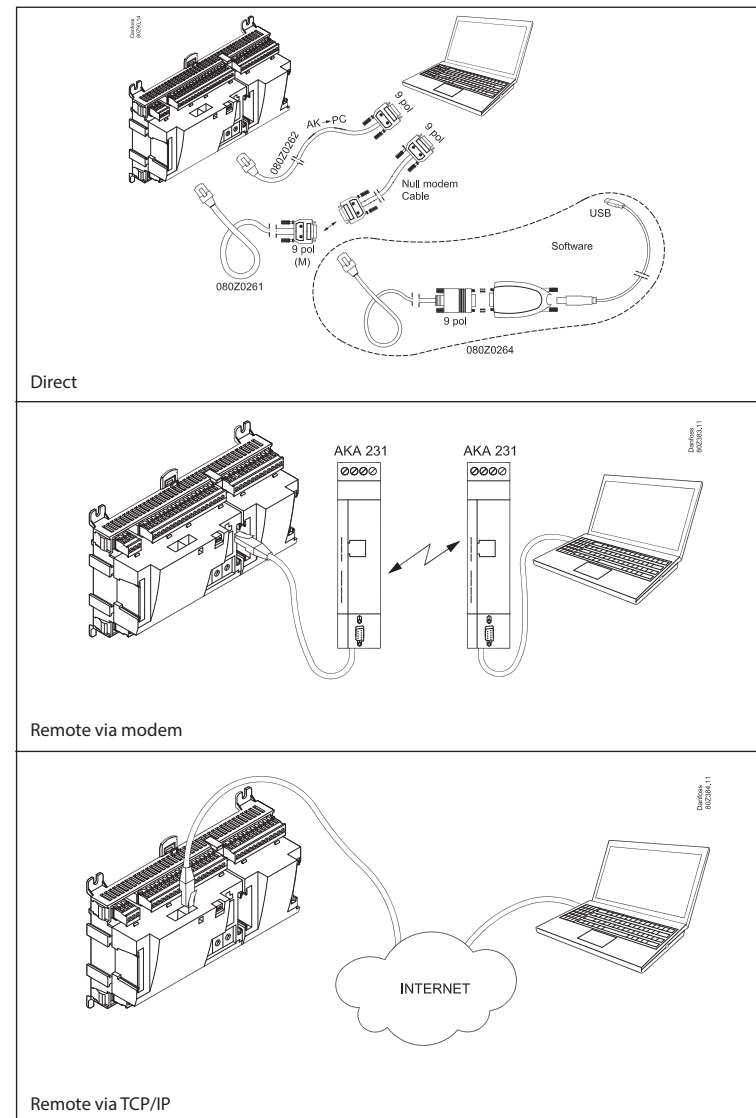



Prior to installation

Pc requirements: Pentium 4, 2.4 GHz, Serial port or USB+converter*
2 GB RAM, 80 GB Harddisk
CD-ROM with activated auto run.

Software requirements: Windows XP SP2 /
Windows 7, 32 bit / 64 bit
Windows 8, 64 bit

Cable: Cable for connection of AK controller.
Order number: 080Z0261 or 080Z0262.
See the illustrations on previous page.

If a longer cable is required between the controller and the PC a standard RS 232 extension cable can be inserted. The distance between controller and PC must however not exceed 15 m.

*) Converter: Order no. = 080Z0264

Plant overview

With this function you can create an overview over a range of data from the plant.

This will contain:

Address, Name of controller, Parameter, Value.

Up to 99 parameters can be gathered, but only those that can be logged.

Example:

Trend	Addr	Name	Parameter Name	value
<input type="checkbox"/>	11:001	AK-SM720	Defrost-Group-7 - Coordinated defrost	False
<input type="checkbox"/>	01:006	AK-PC 781	Condenser status - Pgc	***** Bar
<input type="checkbox"/>	01:054	AK-CC 750	Defrost setup - Defrost control	*****

This is how you define the overview:

1. Press "Home"



2. Press "Site functions" and then "Site overview"

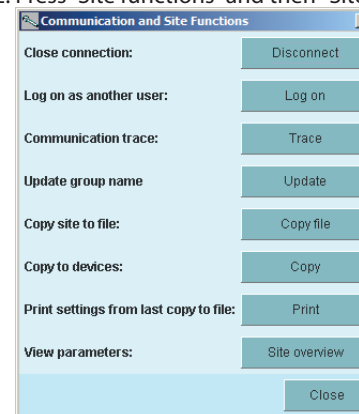

Modem info

Change controller name on plant

You can only access this function in a System Manager.

Customer defined texts

If you wish to change some of the texts that are used in the Service Tool, you can do so in the following way:

1. Select the start screen in configuration

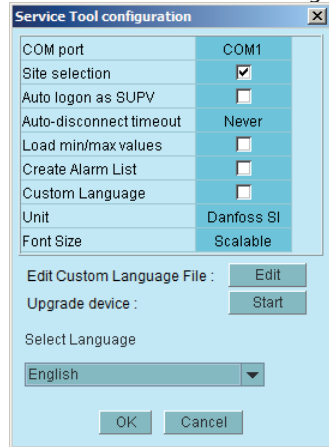

2. Press Edit
3. Type in the original text as you see it. Capital letters and spaces **must** be included.
4. Type in an equal sign “=”
5. Type in your new text.
6. Save the file.
7. Mark the field “Custom Language”
8. Restart the Service Tool

Example:

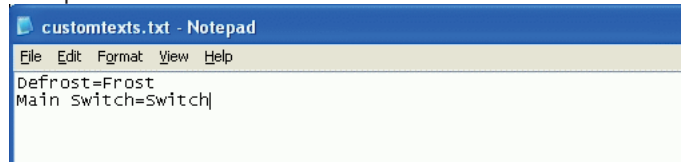

(This setting does not apply to alarm texts).

How to install the programme

1. Place the CD-ROM in the PC drive
2. Installation starts automatically. Follow the instructions on the screen
The drive is optional, but the path **must** be: C:\ADAP-KOOL\ServiceTool
3. After the installation a configuration of the program must be made.

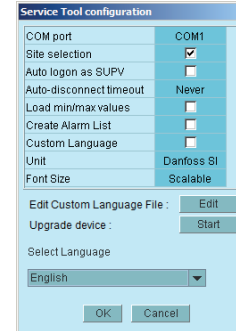

- **COM port:** Indicate the COM port to be used for the direct connection.
- **Site selection:** If you want the option of connecting to the system via a modem or TCP/IP, this must be selected. This means that “site selection” will appear so that you can select system.
- **Auto logon as SUPV:** Select this option if you want automatic login with the “SUPV” user profile.
- **Auto disconnect:** Service Tool closes automatically if idle for the set time. Service Tool closes automatically if idle for the set time.
- **Load min/max values:** Should only be selected if you expect to use offline programming. Uploading takes time. The Service Tool will read and save setting limits for the controllers you connect to.
- **Create alarm list: Generates an alarm list for later use. Name = Alarms.XML**
- **Custom Language:** By marking this function, the program will use texts that are written in the file “Custom Language”. See later on in the text.
- **Unit:** Select unit. (Bar and °C, or Psi and °F)
- **Font size: Choose size or let it be scalable**
- **Edit Custom Language file:** This function gives you access to change texts for selected functions. Read more on page 20.
- **Upgrade device: Use only if the software in the connected controller needs to be updated. Read more on page 23.**
- **Select language:** Must be set for the language you wish to use. If the controllers contain the selected language, this language will be dominant on the operating controllers. If not, English will be shown.



Before you start the programme

1. Connect controller and PC

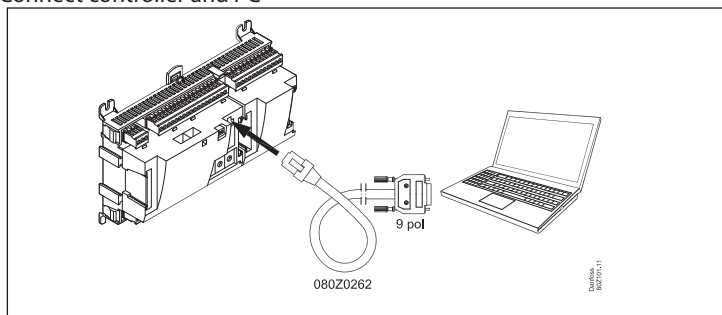

Or to the network via the System Manager, if applicable.

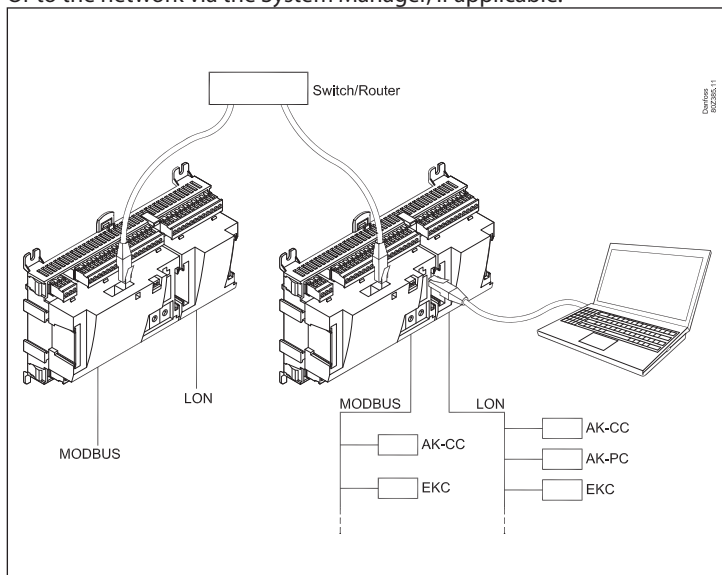

2. Switch on the controller if it is not already switched on.

Languages

The individual controllers operated by the Service Tool contain one or more language selections. English texts are available in all controllers. On those controllers where it is possible to select a language, the desired language will be shown in the display. However the controller will return to English in cases where the translation is incomplete.

A number of controllers only have English (primarily the EKC series). In these cases the Service Tool downloads a translation from a file supplied with the tool. The language selection is carried out in the display where the Service Tool can be configured. If the selected language is not found in the supplied file, the controller will return to English.

Alarm texts

The language for alarm texts has to be set in the System Manager AK-SM 720 and the connected controllers.

In this function, the System Manager will show the desired language, if it exists in the System Manager. If not, the alarm text will return to English. The alarm texts from the EKC controllers will also be shown in the desired language.

Off line settings

Here you can work on a file which you can then later transfer to a controller.

It is required that you have a basic file to work from. This must be a file with the same order number and software version as the controller.

The file is a backup file from a system.

It is possible to change settings. Measured values will of course not be displayed. Likewise, functions requiring online connections are omitted.

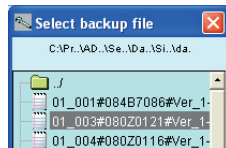
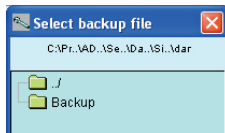
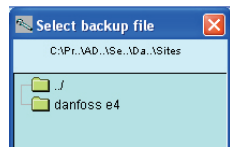
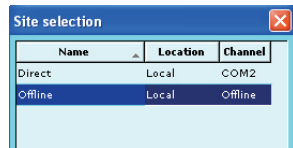

1. Select site , Offline, Press Connect

2. Select backup folder

3. Select file. The file is named in the following way: "network address" # "order number" # "software version" # "controller name".

If min/max values do not exist in the file, a dialogue will appear.

The decision to download min/max values must be set under the Service Tool setup (see above)."

The set values will be saved automatically along the way.

How to start the programme

1. Via the Start menu move to "Service Tool"

(In the PC the application is found in the "ADAP-KOOL" folder)

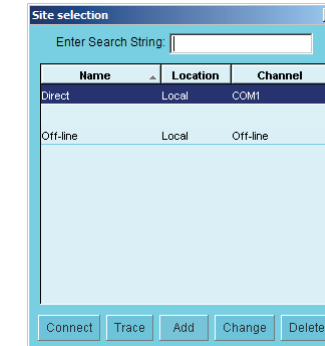

2. Select "Direct" when the PC is connected directly to a controller.

(Later there may be several lines where you can select connections to other systems, e.g. via modem or TCP/IP connection.)

3. Press "Connect"

When the programme encounters a new controller for the first time, a file will be downloaded to the PC. This transaction will take a couple of minutes. You can follow the transfer on the bar at the bottom of the screen.

4. Select user level

The various user levels range from "seeing only" to carrying out installation and setup of the plant. There is an overview on page 11.

The user name with the greatest powers is from the "SUPV" factory (super user).

5. Logon

The first time you start the programme, use the "123" pass- code. This code has been put in by the factory and can be used on all user levels until it is changed.

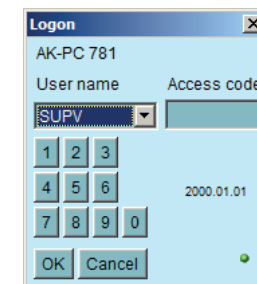

When you are in contact with the controller it is the relevant controller's data and setting options that have to be operated. They are described in separate manuals.



General navigation

Here you will get an impression of what a controller's control panel looks like. The icons vary according to the controller switched on. But generally the operating blocks are as shown here:

Communication and system functions

You have the following options:

- Disconnecting
- Changing user profile
- Viewing communication log
- Update group name (see page 21)

And if you are connected to a System Manager:

- Backing up all units on the network
- Copying set-up from a file to a unit
- Printing settings for all or selected units on the network
- Network overview

One of the controllers functions

Each key gives access to data concerning the regulation and possibility of adjusting it. When you have received the required information/ adjusted the parameters, you can click your way down to another level and obtain a similar access.

Back to survey

The key at the button left takes you right back to the shown overview display.

Day/night schedule

Here you can read and set the individual controller's operating performance on a weekly basis. You can also consider deviations in connection with Sundays and holidays.

Manual operation

Here you start and stop the automatic regulation.



Backup

When setting a controller, all of its settings are saved in a backup file. This file can then be saved for security purposes, or it can be used to copy and import settings in a similar controller.

Furthermore, you can use the file for "Offline programming", in which you prepare all settings in order to copy the file onto a controller at a later time.

This function can be found below in the controller's Configuration menu.

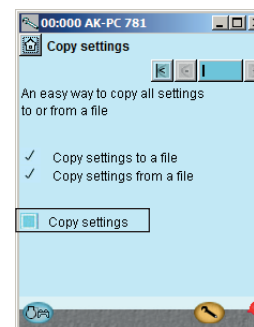
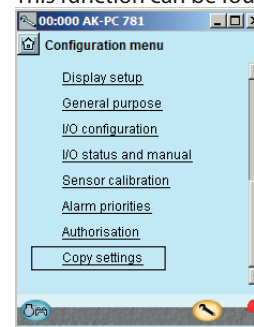

Press "Copy settings"

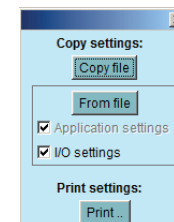

Press "Copy file"

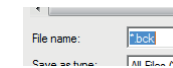

Give the file a name xxx.bck

Connection to an external system

If you need to set up a connection to an external system, this must be done from the "Site selection" screen you see when you start the programme.

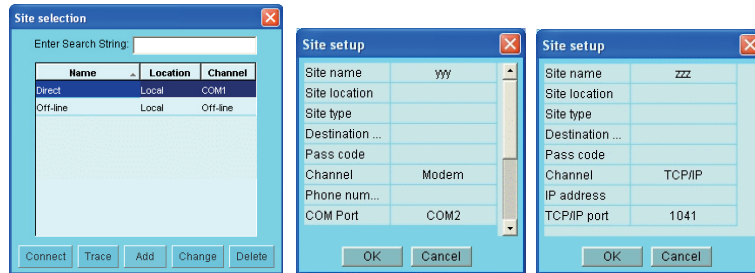

Here the following are shown:

Direct: Used when the controller is connected directly to the PC.

Off line: Used when programming takes place without a controller (see next page).

In addition, it is possible to define external connections, e.g. via modem and TCP/IP.

When the selected connection has been defined, it can be selected just like any other.

Generally about Site Setup

- Site name/location/type are free text fields. Connections are sorted by "Site name"
- Destination name: Must correspond 100% to the destination set up in the recipient's System Manager
- Pass code: Must correspond 100% to the password entered in the recipient's System Manager.

Modem:

- Phone number: Number of recipient.
- Com PORT: Number where the local modem is connected
- Baud: Baudrate to local modem (default is 38400)
- AT1 command: Initiation string to local modem
- Modem type: Free text for modem type.

TCP/IP:

- IP address: IP address of recipient
- TCP port: Must be 1041

DNS name: Use if the recipient uses a DNS address.

Network address

Here you can see the controller's address and name on the network. You can also connect to one of the other controllers on the network.

Regulation navigation

Having selected a controller you can via the "drop down" select from which part of the regulating range you wish to download/adjust data.

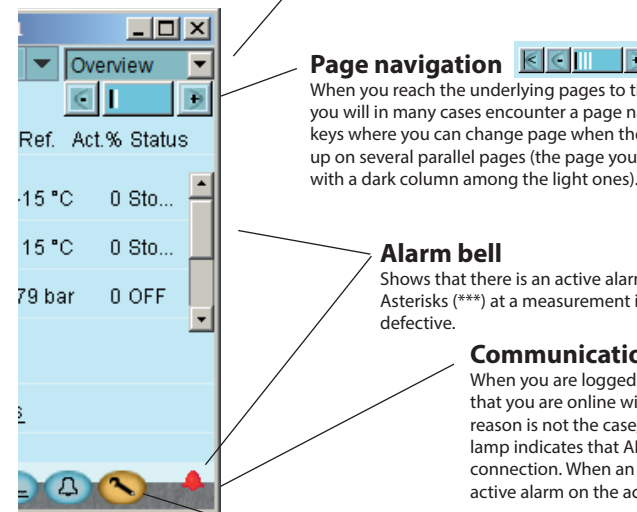

Page navigation

When you reach the underlying pages to the overview display you will in many cases encounter a page navigation option: +/- keys where you can change page when the settings are divided up on several parallel pages (the page you are on is marked with a dark column among the light ones).

Alarm bell

Shows that there is an active alarm that needs handling. Asterisks (***) at a measurement indicates that the signal is defective.

Communication

When you are logged on, a green "lamp" indicates that you are online with the controller. If this for some reason is not the case, the lamp will be red. A yellow lamp indicates that AK2 is trying to establish the connection. When an alarm bell is shown, there is an active alarm on the actual controller.

Configuration

Gives you access to the configuration element – See next page.



(System unit only)

Setting for plant controls (Master control functions)

Alarms

Here you have a list of active and cancelled alarms, respectively. See also page 13

Log function

Here you obtain an overview of the operation viewed from two angles:

- Historically: What has transpired in a given period for selected parameters.
- Trends: shows how the plant is operating here and now – useful data, for example, for tuning of the system to energy-optimal operation or change of application.

Configuration of a controller

»Screw spanner«

Via the function key to the extreme right (with screw spanner icon) you leave the Daily User section of the controller. Instead you now move into the Service User section reserved for installers/ service engineers who either have to configure a controller or carry out basic changes of the existing configuration.

The “screw spanner” leads you to a menu with regulation-specific items for configuration of the application to be controlled.

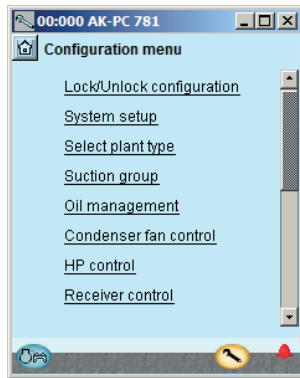

The number of menu items will adapt itself to the application, so that only the relevant menus are visible.

The following items of the menu are always shown, whatever the plant type:

Lock/unlock configuration

Here you lock important settings so that the setup will not be changed by a mistake. Unlock if you want to change in the configuration.

System setup

Here you set the clock and name the controller.

Select plant type

Here you find all the functions and setups that define the plant. There are usually several input angles to the different regulating functions.

Measurement

1. Select a parameter in the field left
2. Lead it into the right field by pressing the arrow button (or double click on the parameter)
3. Finish by pressing “OK”

Data collection starts when the set-up is locked and the controller is started, the clock is set and start is activated.

The Graphic

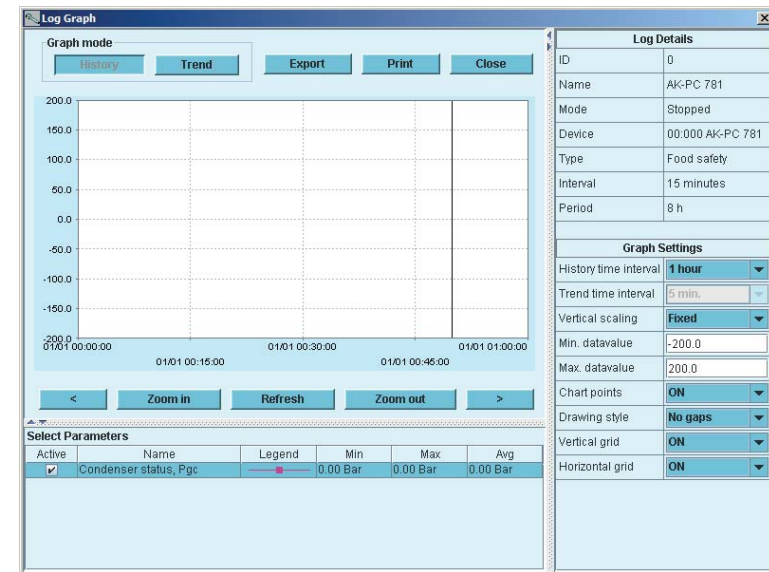

History = Log data, i.e. accumulated data.

Trend = Trend data, that is to say data that are collected and displayed here and now.

Export = Export the collected values to a file.

The file can be opened in Excel.

Print = Print out the accumulated values on a printer.

= Moves back and forth in time.



Log function



Here you can collect measured values and have them presented as curves.

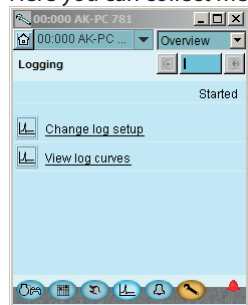

Measurements are defined here.

Graphics are shown and defined here.

Definition of measurements. Here is Pgc selected.

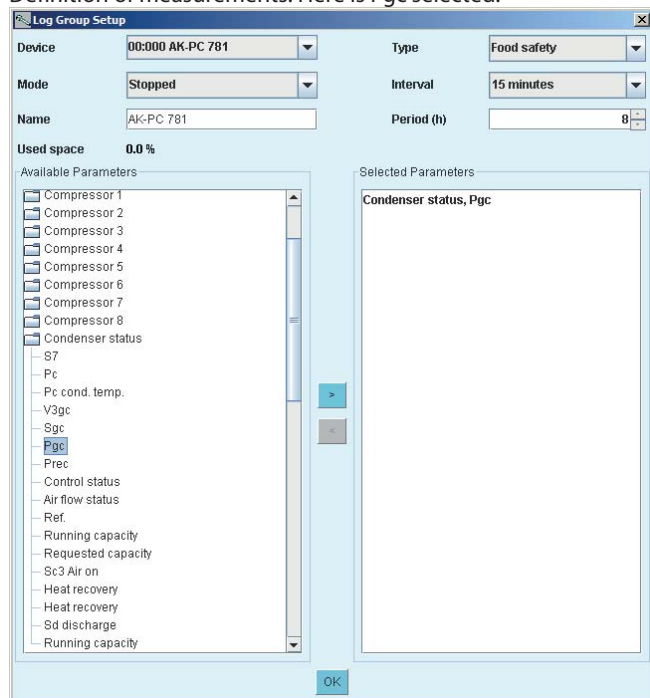

Type = General registration or a collection for service use
Interval = How often to save a value
Period = Time when the measurement is saved. Then overwritten.

I/O configuration

With this function you define the signals there have to be on the different inputs and outputs.

I/O status and manual

Here you can see status and values of the individual inputs and you can carry out manual override of the output signals.

Authorisation

Here users and passwords are defined. The factory settings are as follows:

Profile	User	Read	Write	Password
Dail	Daily	All	No	123
Serv	Service	All	Adjust values	123
Supv	Super user	All	All	123

Backup/restore

Enables you to make a backup of a controller's settings, either with a view to transferring them from a replaced controller to a new one or to making "copy paste" of a controller's settings to new/other controllers with the same code number and software version.

Authorisation of users

New users are established here and existing users can change their access code. To get access to the menu you must be logged on as super user. Only with this user type can you authorise other users and change their access codes.

You can establish four different profiles:

Default (DFLT). Lowest level which only displays elementary operating data.

Daily user (DAIL). Second lowest. Typically for the person responsible for refrigeration in a shop. He/she can read alarms and set operating data and cancel alarms.

Service user (SERV). An installer/service engineer who partly installs and runs in the plant, partly performs more radical settings/adjustments, overriding the automatic controls in connection with a service call.

Super user (SUPV). A plant builder/person responsible for monitoring of it with top-level responsibility. He/she has as the only one the right to authorise other users.

Start by becoming authorised for configuration. You do this by selecting "Supervisor" in the log-in display followed by an access code. You can now set up/authorise new users.

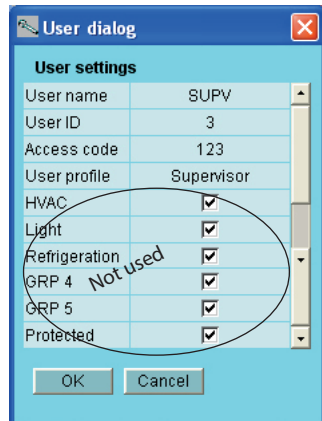

Procedure

1. Give the user a short "name" of max. four characters
2. Supplement with an ID number which is not known/used already
3. Write an access code (a number) which is not higher than 9999
4. Assign the required profile to the new user
5. If it is a large plant and the user needs access to, say, heating and ventilation, the final field must also be checked.
6. Finish with OK.

Alarms

The two alarm displays show the active alarms and earlier alarms, respectively. If you want to know more about one of the alarms you can click on the alarm and in this way download an info display on the screen.

If you wish to confirm that you have seen an alarm, you can check it in the square field. Remember that the error may still be there and has to be corrected.

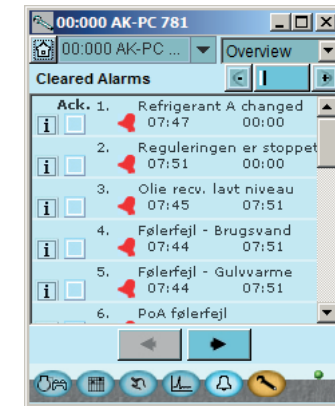
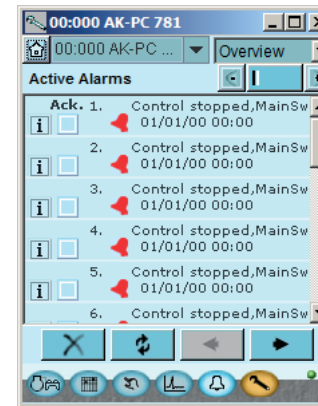

The four keys have the following functions:

- With the first key you sort out the alarms, so that only the active ones will remain
- The second key will update the display (checks whether more alarms have been added while the display was shown).
- With the third and fourth keys you can turn over the pages with alarms. Each page represents 20 alarms