



## Instructions for Placement of Main and Sub Controller

The main and sub controller have an on-board antenna. If one of the modules is incorrectly installed, it might reduce the operating distance between main and sub controller. Consider the guidelines below for best wireless distance:

1. Main and sub controller should be in line of sight.
2. Main and sub controller should be vertically aligned if possible. Height >1 m.
3. Main and sub controller should be pointing front to front if possible.
4. Minimum 1 m between main controllers (if more than one is used).

In general, wireless transmission issues concern terms which can disturb transmission, such as reflection, absorption, multiple paths, interference (Wi-Fi) etc. In order to find the best location for main and sub modules, perform initial operational tests before final attachment. The main controller should not be placed close to a Wi-Fi access point, since Wi-Fi uses the same frequency band as the system.

## Sub Controller Battery Recommendation

If the sub controller operates in temperatures below 0°C or if *Fast Response* option is used, apply 4 batteries.

## Channel Setup (Main and Sub Controller)

In order to set the radio channel on main and sub controller, use DIP sw 1, 2, 3 and 4. There are 16 different channels from 1 to 16. **NOTE:** It is not recommended to use Channel 16.

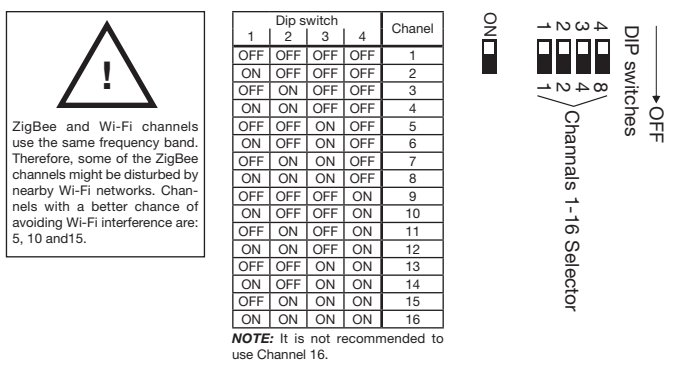

**Best free channel**  
The device communicates in the 2.4 GHz ISM band which is shared with, among others, the Wi-Fi network. For optimum stability, it is very important to select a channel where interference from Wi-Fi networks, USB wireless mice, DECT mobile phones etc. is at a minimum.

When the main controller is in *in Not Associated* mode (red and green LEDs toggle), press the push button briefly (1/2 s) to show best free channel for 10 seconds. Green LED corresponds to DIP sw.1 etc. LED ON=DIP switch ON.  
**NOTE:** *Best Free channel* is a brief energy scan and can only serve as a guideline. A good starting point is a Wi-Fi channel overview. Use for instance a free mobile phone application, such as "Wi-Fi Analyzer" (or similar), which graphically depicts the location of present Wi-Fi networks. Choose a free channel or, alternatively, a channel with a minimum of signal activity.

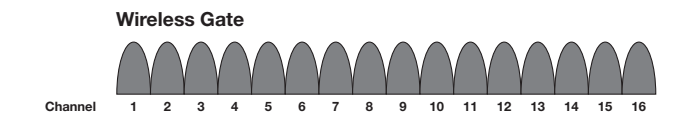
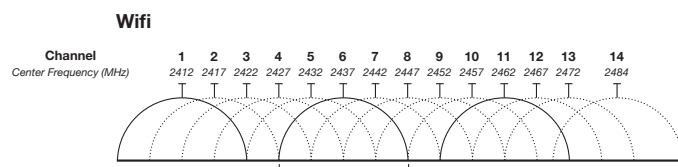

## Active vs. Idle mode (Main and Sub controller)

In general, the system can work in two modes: *Active* and *Idle* mode. Active mode is the "safe" mode. Safe mode is necessary when the gate is opened or closed and needs protection. The system monitors the protection edge and reflects edge status on safety edge relays. Idle mode is a "comfort" function where Edge1-2 status is reflected on safety relays. Response time is slow.

## Test input High/Low (Main Controller)

The test input on the main controller is used to start *Active Time* of the wireless system. The test input can be activated by a high or low signal level, dependent on the DIP switch 5 setting.

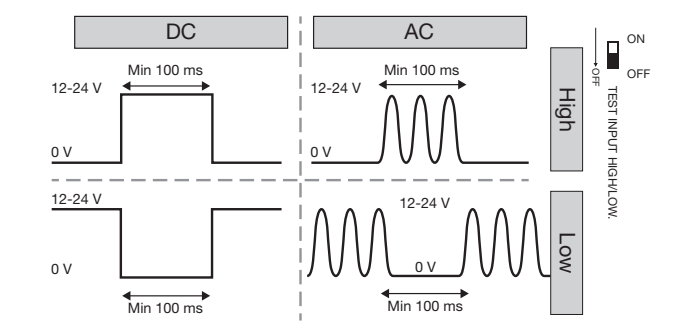

## Active Time (Main Controller)

Dependent on DIP switch 6, 7, 8 settings, *Active time* can be *Fixed* or *Manual*.

**Fixed active time (15-105 s):**  
Active time will according to a fixed time which is set via DIP switch. To start Active time, the test input must be activated and then deactivated. When the test input is deactivated, Active time starts and safety relays will reflect status of the safety edges. When the Active time ends, the safety relays will go briefly into Safe position to indicate end of Active time.

**Manual Active time:**  
Active time will run as long as the test input is activated. When Active time starts and ends, the safety relays will go briefly into Safe position to indicate start and end of Active time.

		A	B	C	Active time
EPD1	Inactive	ON	ON	OFF	15 Sec.
	N.C. ESPE	OFF	OFF	ON	30 Sec.
	N.O 8k2 Ω ESPE	OFF	ON	OFF	45 Sec.
	Photoelectric	ON	OFF	OFF	60 Sec.
EPD2	Inactive	ON	ON	OFF	75 Sec.
	N.C. ESPE	OFF	OFF	ON	90 Sec.
	N.O 8k2 Ω ESPE	OFF	ON	ON	105 Sec.
	Photoelectric	ON	ON	ON	Manual Active Time

## Protection Edge (Sub Controller)

The sub controller can be configured for either N.C. ESPE\*, N.O. 8.2 kΩ ESPE or the low consumption photoelectric ESPE N.C. sensors. **Note:** Unused edges MUST be set to "Inactive".

		Dip 5	Dip 6	Dip 7	Dip 8		
EPD1	Inactive	ON	ON	OFF	OFF	8	EPD2: 8K2/NC
	N.C. ESPE	OFF	OFF	ON	OFF	7	EPD2: PES/MEC
	N.O 8k2 Ω ESPE	OFF	ON	OFF	OFF	6	EPD1: 8K2/NC
	Photoelectric	ON	OFF	OFF	OFF	5	EPD1: PES/MEC
EPD2	Inactive	ON	ON	OFF	OFF	8	EPD2: 8K2/NC
	N.C. ESPE	OFF	OFF	ON	OFF	7	EPD2: PES/MEC
	N.O 8k2 Ω ESPE	OFF	ON	ON	OFF	6	EPD1: 8K2/NC
	Photoelectric	ON	ON	ON	OFF	5	EPD1: PES/MEC

## Fast / Normal Response Time (Sub Controller)

Normal response time (Default) : Limit sw +/- terminals connected  
Fast response time : Limit sw +/- terminals open  
Fast / Normal response option must be selected before association!  
**Note:** Fast mode supports only one sub controller.

## Procedure for installation and wiring

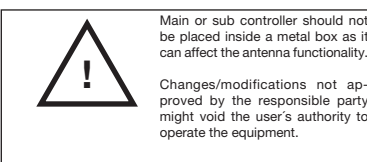

## Main Controller WSM6GA00D24, WSM6GACCD24

Main controller DIP switch: Set the desired radio channel number (1-15) and the required Test Input mode.

(Active High/Low). In addition, set the desired active time (15-105 s or Manual Active Time). The Test input can be connected directly to the door controller or connected to a contact, if no door controller is used.

In case of no door controller, use the following wiring in order to send test input to the main controller by means of a contact:

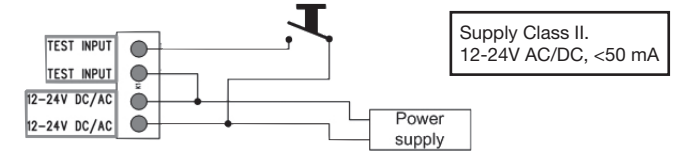

In this case, DIP sw 5 must be in ON position (Active High).

**Power ON**  
Apply power to the main controller. On the main controller, the power and low-batt LEDs should toggle on and off in order to indicate that the device is not associated with any sub controllers.

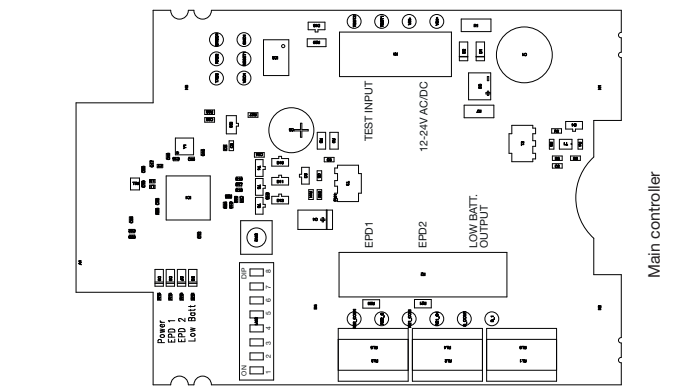

**Power ON**  
Apply power to the main controller. On the main controller, the power and low-batt LEDs should toggle on and off in order to indicate that the device is not associated with any sub controllers.

## Sub Controller WSS2GA2BAT

Sub controller DIP switch: Set the desired radio channel number (1-15) (same as main controller), and the desired entrapment protection device safety edge type(s). Set/remove Normal/Fast response jumper. **Note:** Fast/Normal response option is read only during association.

Connect safety edge (ESPE\*):  
Mechanical (N.C. or N.O. 8.2 kΩ):  
TX+ and TX- terminals.  
Photoelectric low consumption ESPE N.C.:  
See text on PCB.

\*ESPE (electro-sensitive protective equipment)

**Verification/Test**  
Edge1/2 status can be verified on LED1/2.

Activate the push button on the sub controller with a short push (½ s). Now the safety edge1 and safety edge2 LEDs show status of the entrapment protection for the next 30 seconds. LED EPD1 ON=Edge1 not interrupted etc.

## Final Verification

Inspect the installation before putting it into service. Check that the system works as intended.

## Association Procedure (Main and Sub controller)

1. Press the push button on the main controller for more than 3 seconds, until the green LED is continuously lit and safety LED EPD2 starts flashing. The main controller is now in association mode, ready to be connected to the sub controller(s).
2. Go to the sub controller and press the push button for more than 3 seconds. The sub controller now enters association mode and LED EPD2 starts flashing. (Step 2 to be repeated until all sub controllers have been associated).
3. When the association procedure is finished, the sub controller automatically leaves association mode and the LEDs on the sub controller stop flashing. The LEDs flash a number of times corresponding to the respective sub controllers' assigned number in the line.
4. Press the push button on the main controller for more than 3 seconds in order to exit the association mode. The association procedure is now finished and you can start using the system. If no sub controller has been associated to the main controller, the main controller remains in *Not associated* mode (red and green LEDs toggle).

## Low Battery Indication

**Main Controller**  
In case of low battery on one of the connected sub controllers, the *Low Batt* LED turns on and the *Low Batt* relay will be turned off.

**Sub Controller**  
LED EPD1 on the sub controller that has a low battery gives a short flash every second.

## Specifications Main Controller (WSM6GAxxD24)

<b>Rated operational volt. (U<sub>o</sub>)</b>	12 to 24 VAC/DC (-10 +15%) Class II
<b>Ripple (U<sub>r</sub>)</b>	≤ 10%
<b>Supply current</b>	≤ 50 mA
<b>Communication Frequency</b>	2.4 GHz duplex
<b>Channel number</b>	16 selectable via DIP switch
<b>Active time</b>	15 - 105 s, fixed time or manual set

<b>Relay</b>	SPST 2 x ESPE NC or 2 x ESPE NO 8.2 kΩ Low Battery
	1 A / 30 VDC 0.5 A / 30 VAC >100,000 AC11 or DC11

<b>Protection</b>	Reverse polarity, transients
<b>Indications Main Controller</b>	
Power supply	Green LED
ESPE 1 or 2 active	2 x yellow LEDs
Low Battery	Red LED

**Test input**  
(active high or active low)  
Active high  
Active low  
0 V

**Test impulse time**  
Minimum pulse width  
Maximum pulse width

**Relay response on Active time begin/end**  
Start Active Time  
End of Active Time

<b>Response time</b>	t <sub>rise</sub> Fast mode t <sub>rise</sub> Normal mode (1 sub) t <sub>rise</sub> Normal mode (2 sub) t <sub>rise</sub> Normal mode (3 sub)	< 15 ms < 42 ms < 42 ms < 56 ms
----------------------	--	--

t <sub>rise</sub> Normal mode (4 sub)	< 70 ms
t <sub>rise</sub> Normal mode (5 sub)	< 85 ms
t <sub>rise</sub> Normal mode (6 sub)	< 100 ms
t <sub>rise</sub> Idle mode	< 5000 ms

<b>Environmental</b>	
Installation category	III (IEC 60664/60664A; 60947-1)
Pollution degree	3 (IEC 60664/60664A; 60947-1)
Degree of protection	IP66

<b>Rated insulation voltage</b>	50 VDC
---------------------------------	--------

<b>Temperature</b>	
Operating Temperature	-25° to +55°C (-13° to +131°F)
Storage Temperature	-40° to +70°C (-40° to +158°F)

<b>Size</b>	75 x 35 x 125 mm
-------------	------------------

<b>Material</b>	
Housing	Light Grey ABS
Top	Light Grey ABS

<b>Weight</b>	230 g
---------------	-------

<b>Approvals</b>	cULus FCC IC
	UL508, UL325, CE FCC port 15 B.C FCC-ID: Y55WSM0001 RSS210, RSS GEN, RSS-102 IC-ID: 7188C-WSM0001

## Specifications Sub Controller (WSS2GA2BAT)

<b>Rated operational volt. (U<sub>o</sub>)</b>	1 to 4 Lithium 3.6 VDC size AA batteries, >2700 mAh
<b>Supply current</b>	< 40 mA
<b>Communication Frequency</b>	2.4 GHz duplex
<b>Channel number</b>	16 selectable on DIP switch

**ESPE inputs**  
ESPE NC  
ESPE NO 8.2 kΩ  
Photoelectric ESPE  
Mechanical (Normal/Fast)  
Model selector (Normal/Fast)

**Protection**  
Reverse polarity

**Indications Sub Controller**  
ESPE 1  
ESPE 2

**Environmental**  
Installation category  
Pollution degree  
Degree of protection

**Temperature**  
Operating Temperature  
Storage Temperature

**Size**  
22 x 45 x 214 mm

**Material**  
Housing  
Bottom

**Weight**  
220 g

**Approvals**  
cULus  
FCC  
IC

UL508, UL325, CE  
FCC port 15 B.C  
FCC-ID: Y55WSM0001  
RSS210, RSS GEN, RSS-102  
IC-ID: 7188C-WSM0001

## Frequently Asked Questions

- Main Controller**
1. **Why do the green and red LEDs toggle?**  
The main controller is not associated with a sub controller.
  2. **Why do the safety relays remain in safe position?**
    - a. Make sure that the wiring is correct and check that the correct type is selected on the subcontrollers.
    - b. Check if communication with sub controllers is OK. The channel might be wrong or association might have failed
    - c. Make sure that the subcontroller batteries are not drained.
  3. **The protection device is disturbed by another radio frequency. What do I do?**  
You simply switch the main and sub controllers to another channel (you do not need to associate the system again).
- Sub Controller**
4. **Safety edge 1 LED flashes every 1 s. What is wrong?**  
Batteries should be replaced.
  5. **Why do the LEDs EPD1 and EPD2 toggle on and off during the association process?**  
Association timeout. Sub controller did not manage to establish connection with the main controller after 5 seconds. Try again. Alternatively, the RF channel might be noisy. Try to change channel on both main and sub controller.
  6. **How do I change batteries?**  
Remove batteries, wait for 30 seconds and insert new batteries.
  7. **What does ESPE stands for?**  
ESPE stands for Electro Sensitive Protective Equipment.
  8. **The protection device is disturbed by another radio frequency. What do I do?**  
You simply switch the main and sub controllers to another channel (you do not need to associate the system again).

## Safety parameters according to EN ISO 13849-1

MTTFd: 91.89 Jahre  
DCAVG: 97.73%  
Category: 2  
Performance Level: d

## EC Declaration of Conformity

Carlo Gavazzi Industri A/S, Over Hadstenvej 40, DK-8370 Hadsten, Denmark, declare that the product Wireless Safety Edge System for Gates  
**Main controllers: WSM6GA00D24 & WSM6GACCD24,**  
**Sub module: WSS2GA2BAT** is in conformity with  
**The Low-Voltage Directive 2006/95/EC**  
EN60947-5-2 Control circuit devices and switching elements - Proximity switches EN60947-1  
Low-voltage switchgear and controlgear - General rules  
**Electromagnetic Compatibility Directive 2004/108/EC**  
EN61000-6-3 Emission standard for residential, commercial and light-industrial environments  
EN61000-6-2 Immunity for industrial environments  
EN60947-5-2 Control circuit devices and switching elements - Proximity switches  
**(R&TE) Directive 1999/5/EC**  
EN50328 ERM - Data transm. equipm. (2.4 GHz ISM band) using WB modulation techniques  
**Machinery Directive 2006/42/EC,** amended by Directive 98/79/EC  
EN ISO 13849-1:2008  
EN 12978:2003-A1:2009, clause 4.1 b  
For industrial doors only See EN13241-1 EN61496-2  
Electro-sensitive protective equipment  
**EU Construction Products Directive (89/106/EEC)**  
EN13241-1, EN12445, EN12453, EN 12978

Person authorized to compile the technical file:  
K. Soerensen, Carlo Gavazzi Industri A/S, Over hadstenvej 40, DK-8370 Hadsten, Denmark  
EC type examination No. 44 205 14 087601, Notified body 0044  
**TUV Nord Cert GmbH,** Langemarckstr. 20, 45141 Essen, Germany  
Hadsten, 16 June 2014, K. Soerensen (R&D Manager)

## Hinweise zur Platzierung des Haupt- und Nebencontrollers

Der Haupt- und der Nebencontroller sind mit einer integrierten Antenne ausgestattet. Eine unsachgemäße Installation des Haupt- oder Nebencontrollers kann die Betriebsreichweite zwischen Haupt- und Nebencontroller beeinträchtigen. Für optimale Funkreichweite beachten Sie bitte die folgenden Empfehlungen:

1. Zwischen Haupt- und Nebencontroller muss eine direkte Sichtverbindung bestehen.
2. Der Haupt- und der Nebencontroller sollten sich möglichst auf gleicher Höhe befinden. Höhe > 1 m.
3. Haupt- und Nebencontroller sollten mit der Vorderseite zueinander zeigen, falls möglich.
4. Mindestabstand von 1 m zwischen Hauptcontroller (falls mehrere eingesetzt werden).

Generell betreffen die Fragen zur drahtlosen Übertragung Aspekte, welche die Übertragung stören können, zum Beispiel Reflexion, Absorption, mehrere Ausbreitungswege, Interferenzen (Wi-Fi) usw. Führen Sie daher vor der endgültigen Befestigung der Haupt- und Nebencontroller zunächst Funktionstests durch, um die optimale Position für Haupt- und Nebencontroller zu bestimmen. Der Hauptcontroller darf nicht in der Nähe eines Wi-Fi-Access-Points platziert werden, da Wi-Fi auf dem gleichen Frequenzband wie die Schließkantsicherung arbeitet.

## Batterieempfehlung für Nebencontroller

Setzen Sie 4 Batterien ein, wenn der Nebencontroller bei Temperaturen unter 0 °C arbeitet oder die Option für die schnelle Reaktionszeit („Fast Response“) genutzt wird.

## Kanalwahl (Haupt- und Nebencontroller)

Der Funkkanal der Haupt- und Nebencontroller wird mithilfe der DIP-Schalter 1, 2, 3 und 4 festgelegt. Es stehen 16 verschiedene Kanäle mit den Nummern 1 bis 16 zur Verfügung.  
**HINWEIS:** Es wird empfohlen, Kanal 16 nicht zu verwenden.

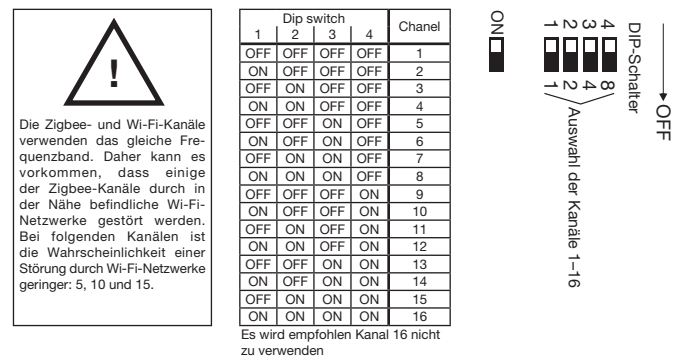

**Beste freie Kanal**  
Das Gerät arbeitet im 2.4-GHz-ISM-Band, das unter anderem von Wi-Fi-Netzwerken genutzt wird. Für optimale Stabilität der Verbindung ist es sehr wichtig, einen Kanal auszuwählen, bei dem die Störungen durch Wi-Fi-Netzwerke, drahtlose USB-Mäuse, schnurlose DECT-Telefone usw. möglichst gering sind.

Wenn der Hauptcontroller mit keinem Nebencontroller verbunden ist (rote und grüne LED leuchten abwechselnd auf), wird bei einem kurzen Tastendruck (1/2 S) für einen Zeitraum von 10 Sekunden der beste freie Kanal angezeigt. Die grüne LED entspricht DIP-Schalter 1 usw. LED Leuchtet = DIP-Schalter ON.

**HINWEIS:** Der beste freie Kanal wird durch einen kurzen Scan der Signalstärke ermittelt und stellt lediglich eine Orientierung dar. Ein guter Ausgangspunkt ist eine Übersicht über die Wi-Fi-Kanäle. Diese kann zum Beispiel mit einer kostenlosen Anwendung für Mobiltelefone wie „Wi-Fi Analyzer“ (o. ä.) erstellt werden, welche die Positionen vorhandener Wi-Fi-Netzwerke grafisch darstellt. Wählen Sie einen freien Kanal oder alternativ einen Kanal mit möglichst geringer Signalaktivität.

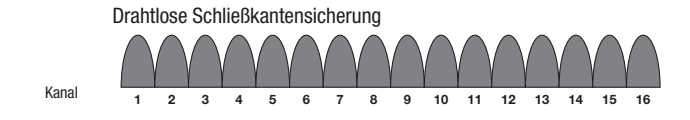
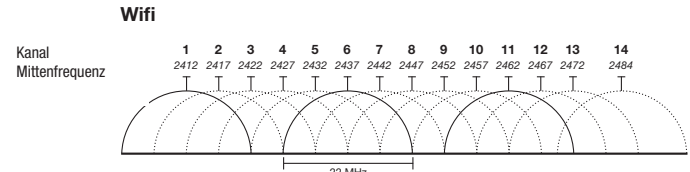

## Active mode und idle mode

Das System kann generell in 2 Betriebsarten arbeiten. Die Betriebsart active mode ist der Sicherheitsmodus. In dieser Betriebsart werden die Schließkanten am Tor beim Öffnen oder Schließen überwacht und deren Status (Schließkante aktiviert bzw. nicht aktiviert) an die entsprechenden Sicherheitsrelais ausgegeben. Die Betriebsart idle mode ist ein Art Komfortfunktion bei der der Status der Schließkanten 1-2 an die entsprechenden Sicherheitsrelais ausgegeben wird.

## Testeingang HIGH/LOW Pegel (Hauptcontroller)

Der Testeingang am Hauptcontroller dient dazu, die Aktivierungsdauer des drahtlosen Systems zu starten. Je nach Einstellung des DIP-Schalters 5 wird der Testeingang durch einen hohen oder einen niedrigen Signalpegel ausgelöst.

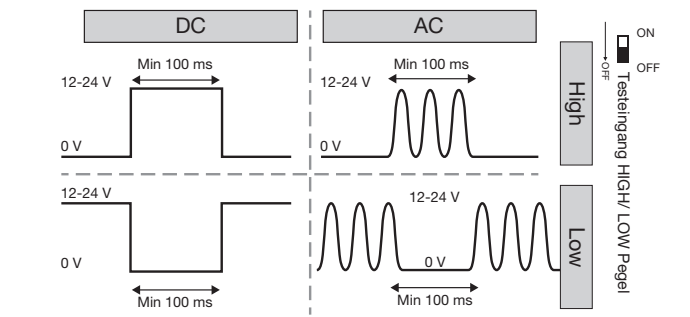

## Aktivierungsdauer (Hauptcontroller)

Je nach Einstellungen der DIP-Schalter 6, 7 und 8 kann die Aktivierungsdauer auf einen festen Wert eingestellt oder manuell gesteuert werden.

**Feste Aktivierungsdauer (15-105 s):**  
Die Aktivierungsdauer umfasst einen festen Zeitraum, der mithilfe der DIP-Schalter festgelegt wird. Zum Starten der Aktivierungsdauer muss der Testeingang ausgelöst und dann wieder deaktiviert werden. Wenn der Testeingang deaktiviert wird, startet die Aktivierungsdauer, und der Status der Schließkanten wird an die Sicherheitsrelais ausgegeben. Nach Ablauf der Aktivierungsdauer wechseln die Sicherheitsrelais kurz zur Sicherheitsposition, um das Ende der Aktivierungsdauer zu signalisieren.

**Manuelle Aktivierungsdauer:**  
Die Aktivierungsdauer läuft, so lange der Testeingang aktiviert ist. Zu Beginn und nach Ablauf der Aktivierungsdauer wechseln die Sicherheitsrelais kurz zur Sicherheitsposition, um den Start oder das Ende der Aktivierungsdauer zu signalisieren.

		A	B	C	Aktivierungsdauer
EPD1	Inactive	ON	ON	OFF	15 Sec.
	N.C. ESPE	OFF	OFF	ON	30 Sec.
	N.O 8k2 Ω ESPE	OFF	ON	OFF	45 Sec.
	Photoelectric	ON	OFF	OFF	60 Sec.
EPD2	Inactive	ON	ON	OFF	75 Sec.
	N.C. ESPE	OFF	OFF	ON	90 Sec.
	N.O 8k2 Ω ESPE	OFF	ON	ON	105 Sec.
	Photoelectric	ON	ON	ON	Manuelle Aktivierungs-dauer

## Schließkante (Nebencontroller)

Der Nebencontroller hat Eingänge für ESPE Schließkanten in NC Ausführung, NO 8.2 kΩhm und die für die Ereignislogschranken mit niedrigem Stromverbrauch der Serie PB11 Hinweis: Nicht verwendete Leitern MÜSSEN auf „Inaktiv“ eingestellt werden!  
\*ESPE (berührungslös wirkende Schutzeinrichtung [Electro Sensitive Protective Equipment])

		Dip 5	Dip 6	Dip 7	Dip 8		
EPD1	Inactive	ON	ON	OFF	OFF	8	EPD2: 8K2/NC
	N.C. ESPE	OFF	OFF	ON	OFF	7	EPD2: PES/MEC
	N.O 8k2 Ω ESPE	OFF	ON	OFF	OFF	6	EPD1: 8K2/NC
	Photoelectric	ON	OFF	OFF	OFF	5	EPD1: PES/MEC
EPD2	Inactive	ON	ON	OFF	OFF	8	EPD2: 8K2/NC
	N.C. ESPE	OFF	OFF	ON	OFF	7	EPD2: PES/MEC
	N.O 8k2 Ω ESPE	OFF	ON	ON	OFF	6	EPD1: 8K2/NC
	Photoelectric	ON	ON	ON	OFF	5	EPD1: PES/MEC

## Schnelle/normale Reaktionszeit (Nebencontroller)

Normale Reaktionszeit (Werkseinstellung) : Anschlussklemmen LIMIT SWITCH - und LIMIT SWITCH + sind gedrückt.  
Schnelle Reaktionszeit: Anschlussklemmen LIMIT SWITCH - und LIMIT SWITCH + sind nicht gedrückt.

Die Wahl zwischen schneller und normaler Reaktionszeit muss vor der Anmeldung erfolgen! Hinweis: Bei der Option schnelle Reaktionszeit kann nur ein Nebencontroller angeschlossen werden.

## Vorgehensweise bei Installation und Verkabelung

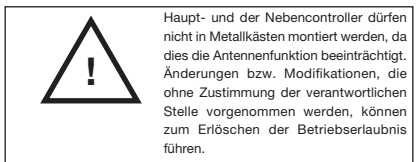

## Hauptcontroller WSM6GA00D24, WSM6GACCD24

DIP-Schalter des Hauptcontrollers: Legen Sie den gewünschten Funkkanal (1-15) und den erforderlichen Testeingangsmodus fest (Aktiv hoch/niedrig).  
Stellen Sie außerdem die gewünschte Aktivierungsdauer ein (15-80 s oder manuelle Aktivierungsdauer).

Der Testeingang kann direkt mit dem Türcontroller oder mit einem Kontakt verbunden werden, falls kein Türcontroller verwendet wird.  
Wenn kein Türcontroller eingesetzt wird, führen Sie die Verkabelung folgendermaßen aus, um den Testeingang mithilfe eines Schalters an den Hauptcontroller zu senden: