

Smart Dupline® Aurora line, Temperature Controller Type SHA4XTEMDIS



- smart-house temperature controller with display
- Developed to fit into wall socket from Fuga, NICO and Bticino
- Shows current room temperature, floor temperature, shows outdoor temperature
- Turns on/off heating and cooling
- Sets wanted room/floor temperature
- Energy Saving through 3 heating setpoints and 3 cooling setpoints
- Delivered with 2 white and 1 black pushbutton covers
- White LEDs: programmable guidelight functions/display backlight
- Blu LEDs: each LED will give a feedback, when the relevant push button is pressed

Product Description

SHA4XTEMDIS is a temperature display with 4 buttons and 4 LEDs. It is developed to be mounted into a 44 x XX wall socket from Fuga, NIKO and Bticino. The TEMDIS display can manage 6 automatic setpoints (3 for heating and 3 for cooling)

and one manual setpoint to let the user manage in the most comfortable way the temperature in his home. The TEMDIS is part of the smart-house concept for building automation applications.

Ordering Key

SH A 4X TEMDIS

smart-house _____
Aurora line _____
Housing 44 x 44 mm _____
Temperature display _____

Type Selection

| Housing | Colour | LEDs | Bus supplied |
|------------|---------------|------------------|--------------|
| 44 x 44 mm | White/Black * | 4 white / 4 blue | SHA4XTEMDIS |

*Delivered with white and black pushbutton covers

Input Specifications

| | |
|------------------------------------|--|
| Sensor | 1 integrated temperature sensor |
| Range | -10 to +50°C (32 to 122°F) |
| Accuracy | ± 1°C |
| Floor sensor (not included) | |
| Temperature range | -10 to +50°C (32 to 122°F) |
| Cable length | 4 m |
| Cable consists of 4 wires: | |
| Brown | Connect to “+” on Temperature controller |
| Yellow | Connect to “C” on Temperature controller |
| White | Connect to “d” on Temperature controller |
| Green | Connect to “1” on Temperature controller |

See wiring diagram

The floor sensor is an active 4-wire sensor and must be ordered separately: the part number is BSO-TEMDIG.

Output Specifications

| | |
|-------------|------------------|
| LEDs | 4 white / 4 blue |
|-------------|------------------|

Dupline® Specifications

| | |
|---------------------------------|-------|
| Voltage | 8.2 V |
| Maximum Dupline® voltage | 10 V |
| Minimum Dupline® voltage | 5.5 V |
| Maximum Dupline® current | 13 mA |

Supply Specifications

| | |
|---------------------|--------------------------|
| Power supply | Supplied by Dupline® bus |
|---------------------|--------------------------|

General Specifications

| | | | |
|---|--|---|--|
| Address assignment | Automatic: the controller recognises the module through the SIN (Specific Identification Number) that has to be fitted in the Sx Tool. | Weight | 50 g |
| Environment Degree of protection Pollution degree Operating temperature Storage temperature Humidity (non-condensing) | IP 20 3 (IEC 60664) -10° to +50°C (14° to 122°F) -20° to +70°C (-4° to 158°F) 20 to 80% RH | Approvals | cULus, according to UL60950 UL notes: Max room temperature: 40°C |
| Connection Screwless detachable D+ D- | 0.2 to 1.5 mm ² Signal GND | CE Marking | Yes |
| Housing Back part dimensions Back part + front dimensions Back part material Push button covers Accessories | 44 x 44 x 25.2 mm 44 x 44 x 28.6 mm Plastic, transparent Plastic, white (RAL 9010) Plastic, clear white (RAL 9016) Plastic, black Transparent plastic ring for Bticino frame | EMC Immunity - Electrostatic discharge - Radiated radiofrequency - Burst immunity - Surge - Conducted radio frequency - Power frequency magnetic fields - Voltage dips, variations, interruptions Emission - Conducted and radiated emissions - Conducted emissions - Radiated emissions | EN 61000-6-2 EN 61000-4-2 EN 61000-4-3 EN 61000-4-4 EN 61000-4-5 EN 61000-4-6 EN 61000-4-8 EN 61000-4-11 EN 61000-6-3 CISPR 22 (EN55022), cl. B CISPR 16-2-1 (EN55016-2-1) CISPR 16-2-3 (EN55016-2-3) |

Mode of Operation

Symbol description:

On the display the following five symbols are used:

 Temperature symbol 1: it indicates that the regulating temperature is currently shown on the display.

 Temperature symbol 2: when steady, it indicates that the second probe is shown (floor if the TEMDIS is regulating according to room temperature, or room probe if TEMDIS is regulating according to floor temperature). When flashing, it indicates the external probe if configured.

 Heat symbol, indicating that a heat application is currently selected. When the symbol is blinking, the unit is heating. When the symbol is steady, Heat mode is selected.

 Frost symbol, indicating

that a cooling application is currently selected. When the symbol is blinking, the unit is cooling. When the symbol is steady, Cooling mode is selected.

 T1 symbol, indicating that the current application is regulated according to setpoint1.

 T2 symbol, indicating that the current application is regulated according to setpoint2.

 T3 symbol, indicating that the current application is regulated according to setpoint3.

 Manual symbol, indicating that the current application is regulated according to a manual setpoint

 The temperature is shown in degrees Celsius.

 The temperature is

shown in degrees Fahrenheit.





Starting Up

When the temperature controller is connected to the smart-house bus, the display digits will start flashing. The display will continue to flash until a complete status has been received from the smart-house controller. This will take approximately 1 min. When the temperature controller has received a complete status, the display will stop flashing and will show the current application status and room or floor temperature.

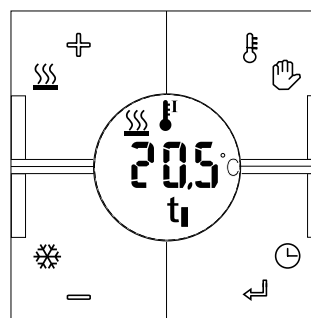
Function Description



After the start-up has finished, normal operation will begin. The user has the following options.







| Button | Name | Description |
|---|-------|---|
|  | HOME | Shows the different probes and enters hand mode |
|  | ENTER | Shows clock and enters setpoint modification status |
|  | DOWN | Enters adjust cooling temperature setpoint |
|  | UP | Enters adjust heating temperature setpoint |

Mode of Operation (cont.)

Temperature option ⁽¹⁾

When the HOME key () is pressed briefly, the current floor temperature is shown (or room temperature if the system is regulated according to the floor temperature) for 10 seconds and the symbol  (not flashing) will be seen. If HOME key is pressed again within 10 seconds, it displays the external temperature (symbol  flashing). If it is pressed again within 10 seconds it returns to the probe control. If the floor probe or the external probe are not connected, the display will show ---.





Heating setpoints visualization ⁽¹⁾

By pressing the UP () key briefly, the current heating setpoint is shown. If pressed again within 10 seconds, the other heating setpoints (T1, T2, T3, OFF) are displayed with the relevant symbols  ,  ,  . If no keys are pressed, after 10 seconds the display will again show the current probe value.

Selecting a different heating setpoint

Once the required setpoint is selected using the UP key, press ENTER () key to confirm it.



Cooling setpoints visualization ⁽¹⁾

By pressing the DOWN () key briefly, the current cooling setpoint is shown. If pressed again within the 10 seconds the other cooling setpoints (T1, T2, T3, OFF) are displayed with the relevant symbols  ,  ,  . If no keys are pressed, after 10 seconds the display will show again the current probe value.

Selecting a different cooling setpoint

Once the required setpoint is selected using the DOWN key, press ENTER () key to confirm it.

Entering hand mode ⁽¹⁾

When the HOME key () is kept pressed for 3 seconds, you enter hand mode and a manual setpoint can be chosen: the hand symbol () will be shown. To exit from hand mode, keep the HOME key pressed for 3 seconds. In hand mode, if UP or DOWN key are pressed, only the hand set is displayed and you do not access the three automatic sets.

Changing the value of a setpoint

From the setpoint visualization, whether manually or automatically, if the ENTER key is kept pressed for 3 seconds, the setpoint value will start flashing: with the keys UP and DOWN it is possible to modify the setpoint in steps of 0.5°C. By keeping pressed UP and DOWN pressed you have double speed. To confirm press ENTER key: the setpoint value will be modified.

Entering the Temporary Mode ⁽¹⁾

Once the required setpoint is selected, press the ENTER key to activate the Temporary Mode temperature control according to the setpoint selected; after this change the main page and the hand symbol will flash to indicate that the Temporary Mode has been chosen.

Exiting from the Temporary Mode

When the main page is shown, press and hold

the UP or DOWN key for 3 seconds to exit from Temporary Mode and return to normal operation mode.

Automatic exit from the Temporary Mode ⁽¹⁾

This setpoint remains active until the expiry time at midnight.

Time clock visualization

If the ENTER key is pressed briefly in home status (when the value of the current probe is shown), the clock is displayed. You should return to the display of the probe for timeout (10 seconds) or after having pressed ENTER key briefly. The ENTER key pressed briefly in any other status functions only confirms and does not display the hour.

Deadband ⁽¹⁾

If deadband is used, TEMDIS shows the setpoints with no deadband, but regulates the temperature according to (setpoint-deadband) for heating, (setpoint+deadband) for cooling.

Addressing

If the light switch module is connected to the Sx2WEB24 controller, no addressing is needed since the module is provided with a specific identification number (SIN): the user has only to insert the SIN number in the Sx Tool when creating the system configuration.

LED programming

The LEDs are also configurable via the Sx Tool:

- White LEDs. The 4 white LEDs can be individually programmed as guide lights.
- Blue LEDs: The 4 blue LEDs will be ON when the relevant push-button is

pressed.

Wall Socket and frame compatible with the Aurora line

The Aurora 44x44 light switch can fit into the frames and wall sockets listed below: for any other model not included here below, Carlo Gavazzi does not guarantee any compatibility.

- Niko
- Fuga
- Bticino: Light, Living, Luna series (the transparent ring has to be used).

The SHA4XTEMDIS is compatible with all the 44 x XX Biticino socket just adding a plastic cap by Biticino.

⁽¹⁾ If programmed by software.

Dimensions

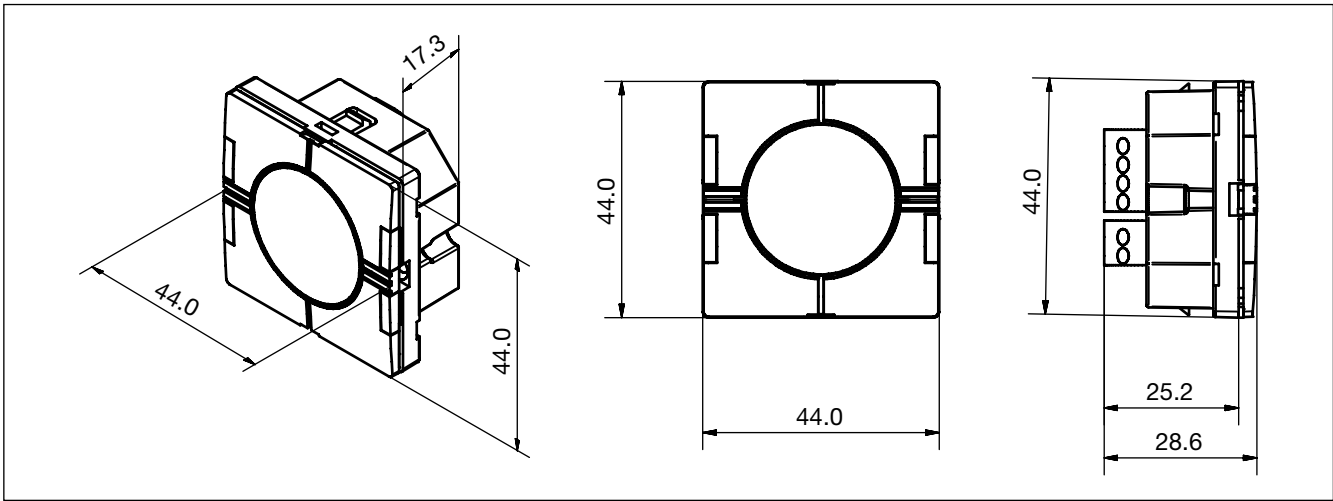

Wiring Diagram

