

PD30ETD02xxWE



Photoelectrics, Extreme wide angle - Diffuse reflective



Main features

- Miniature sensor range
- Sensing range: 200 mm
- Sensitivity adjustment by potentiometer
- Modulated, infrared light 850 nm
- Supply voltage: 10 to 30 VDC
- Output: 100 mA, NPN or PNP preset
- Make and break switching function
- LED indication for output, stability and power ON
- Protection: reverse polarity, short circuit and transients
- Cable and plug versions
- Excellent EMC performance
- The extremely wide-angled light beam eliminates false detection due to e.g. large holes in a PCB
- Ecolab

Main functions

- Detects presence or absence of objects by detecting reflected light energy from the object

Description

The PD30ET... stainless steel sensors are built with high-quality materials and designed for harsh environments.

They are designed for use in environments where high-pressure cleaning, cleaning agents and disinfectants are used on a daily basis.

The strong stainless steel (AISI316L) together with high-quality plastic materials like PEEK, PPSU, and PES sealings of FKM ensure a safe and excellent mechanical resistance.

The sensor housing has the IP69K rating as well as approval by ECOLAB for cleaning and disinfection agents.

The compact sensor design is ideally suited to confined spaces.

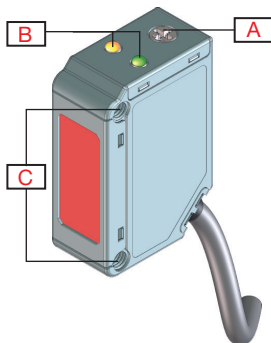

Fig. 1 Cable

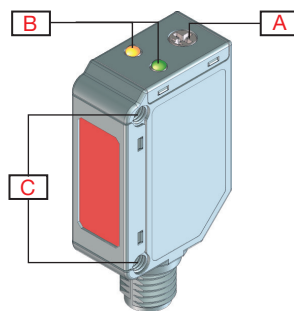

Fig. 2 Plug

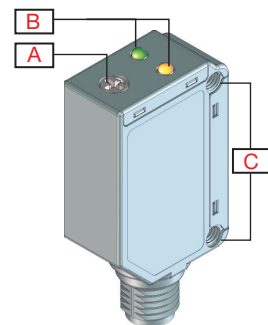

Fig. 3 Back

PD30ETD02xxWE



Element	Component	Function
A	Potentiometer	Adjustment
B	2 LEDs	Green LED: Power ON / Signal stability. Yellow LED: Output
C	2 M3	Fixing holes for sensor mounting

Sensing

Detection

Rated operating distance (S_n)	≤ 200 mm	Reference target, white paper with 90 % reflectivity, Size 200x200 mm
Sensitivity adjustment	20 mm ... 200 mm	Single-turn potentiometer
	210°	Electrical adjustment
	240°	Mechanical adjustment
Blind zone	≤ 0 mm @ S _n max	Reference target, white paper with 90 % reflectivity, Size 200x200 mm
Hysteresis	5% ... 20%	
Light source	850 nm	Infrared
Light type	Infrared modulated	
Detection angle	± 20°	@ 100 mm (half sensing distance)
Light spot size	85 mm	@ 100 mm (half sensing distance)
Emitter beam angle	± 23.0°	@ 100 mm (half sensing distance)

Accuracy

Temperature drift	≤ 0.2%/°C
--------------------------	-----------

Detection diagram

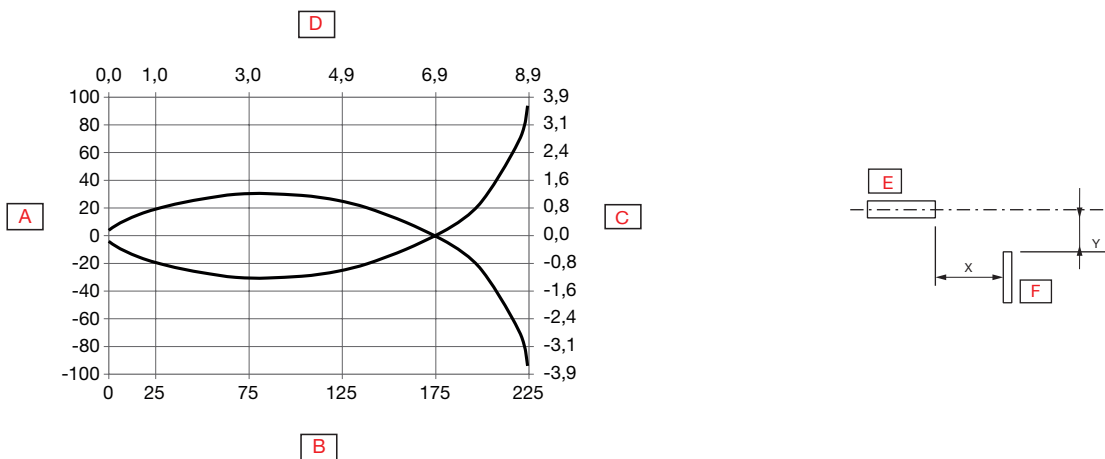

A	Detection width (mm)	E	Sensor
B	Distance (mm)	F	Object
C	Detection width (inches)		
D	Distance (inches)		



Excess gain

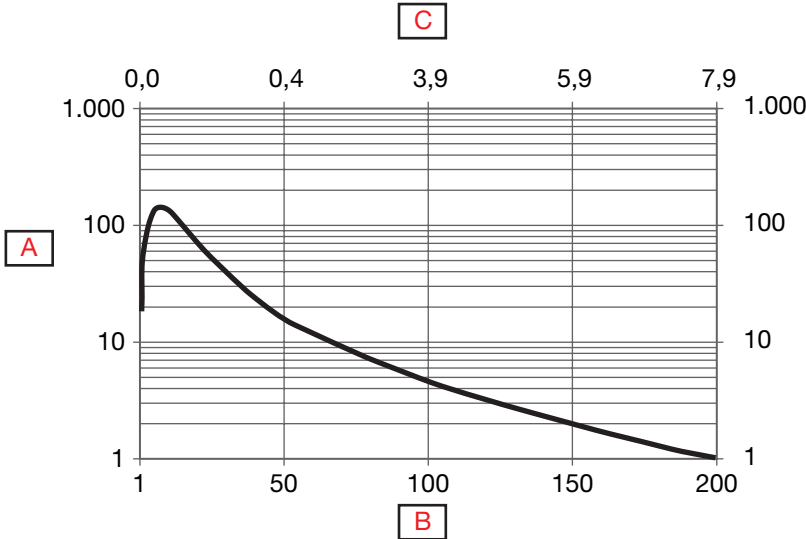

A	Excess gain	C	Distance (inches)
B	Distance (mm)		



Features

Power Supply

Rated operational voltage (U_B)	10 ... 30 VDC (ripple included)
Ripple (U_{rpp})	$\leq 10\%$
No load supply current (I_o)	≤ 25 mA @ U_B max
Power-ON delay (t_v)	≤ 30 ms

Outputs

Output functions	NPN or PNP by sensor type	Open collector
Output switching function	N.O. and N.C.	
Output current	< 100 mA	Continuous(I_o)
	≤ 100 mA @ Load: 100 nF	Short-time (I)
Minimum operational current (I_m)	0.5 mA	
OFF-state current(I_r)	100 μ A	
Voltage drop (U_d)	2 VDC @ (I_o) max.	
Protection	Short circuit, reverse polarity and transients	
Utilization category	DC-12	Control of resistive loads and solid-state loads with optical isolation
	DC-13	Control of electromagnets

Operation diagram

T_v = Power-ON delay



Response times

Operating frequency (f)	≤ 1000 Hz	
Response times	≤ 0.5 ms	OFF-ON (t_{ON})
	≤ 0.5 ms	ON-OFF (t_{ON})



Indication

Green LED	Yellow LED	Power	Output
ON	OFF	ON	OFF (stable)*
OFF	OFF	ON or OFF	OFF
OFF	ON	ON	ON
ON	ON	ON	ON (stable)*

*See signal stability curve

Signal stability indication

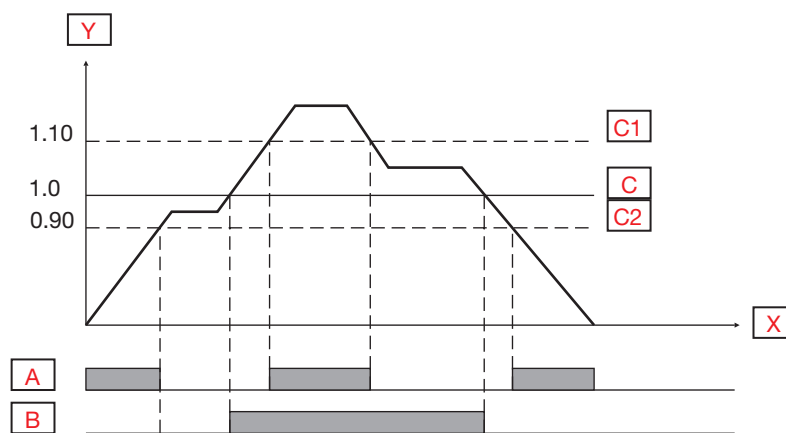

A	Green LED ON	C1	Operation level x 1.10
B	Yellow LED OFF	C	Operation level
X	Time	C2	Operation level x 0.90
Y	Excess gain		

Environmental

Ambient temperature	-25° ... +60°C (-13° ... +140°F)	Operating, Cable version ¹⁾
	-40° ... +60°C (-40° ... +140°F)	Storage Plug version ¹⁾
	-40° ... +70°C (-40° ... +158°F)	Storage
Ambient light	≤ 10 000 lux	@ 3000 ... 3200 °K
Vibration	10 ...150 Hz, 1.0 mm/15 g	EN 60068-2-6
Shock	30 g _n / 11ms, 6 pos, 6 neg per axis	EN60068-2-27
Drop test	2 x 1 m and 100 x 0.5 m	EN 60068-2-31
Rated insulation voltage (U_i)	50 VDC	
Dielectric insulation voltage	≥ 500 VAC rms	50/60 Hz for 1 min.
Rated impulse withstand voltage	≥1 kV	1.2/50 μs
Pollution degree	3	EN60947-1
Overvoltage category	III	IEC60664; EN60947-1
Degree of protection	IP68 @ 2m and 20 h	IEC60539; EN60947-1
	IP69K	DIN 40050-9
NEMA Enclosure Types	1, 2, 4, 4X, 5, 6, 6P	NEMA 250
Ambient humidity range	35% ... 95%	Operating ²⁾
	35% ... 95%	Storage ²⁾



- 1) Do not bend the cable in temperatures below -10°C
 2) With no icing or condensation

EMC

Electrostatic discharge immunity test	$\pm 8 \text{ kV @ air discharge or}$ $\pm 4 \text{ kV @ contact discharge}$	IEC 61000-4-2
Radiated radio-frequency electromagnetic field immunity test (80 MHz ... 1 GHz and 1.4 GHz ... 2 GHz)	10 V/m	IEC 61000-4-3
Electrical fast transient/Burst immunity test	2 kV / 5 kHz using the capacitive coupling clamp	IEC 61000-4-4
Conducted disturbances induced by radio-frequency fields immunity test (150 kHz ... 80 MHz)	10 Vrms	IEC 61000-4-6
Power frequency magnetic field immunity test	30 A/m 38 μT	IEC 61000-4-8

Mechanics/electronics

▶ Connection

Cable	2 m, 4-wire 4 x 0.14 mm ² , Ø = 3.3 mm, PVC, Black
Plug	M8, 4-pin, male

▶ Wiring

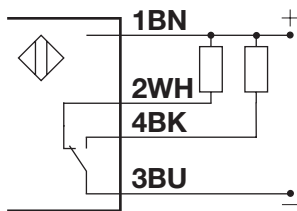

Fig. 4 NPN

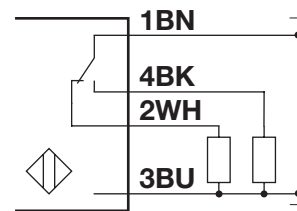

Fig. 5 PNP

BN	WH	BK	BU
Brown	White	Black	Blue

▶ Housing

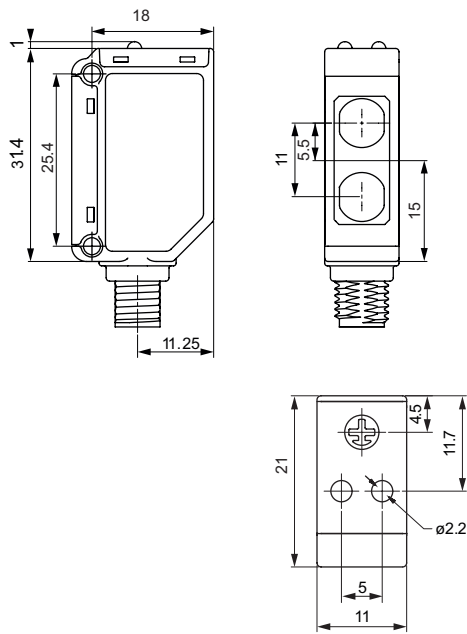
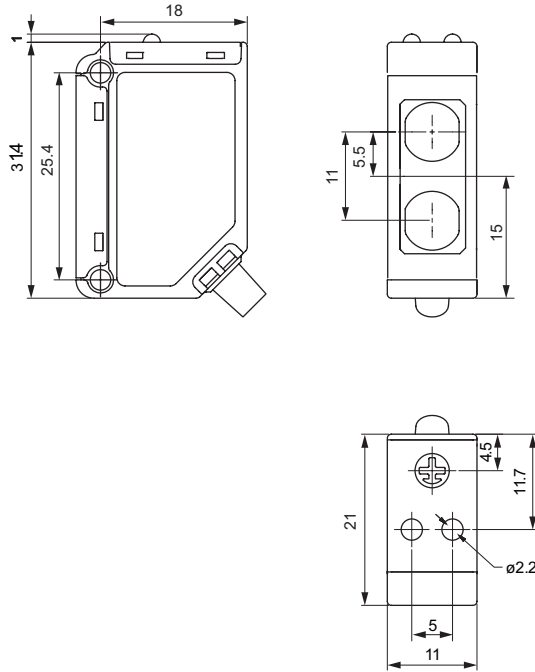

Body	Stainless steel, AISI316L	
Front glass	PPSU, Red	
Trimmer shaft	PEEK, Light grey	
Indication	PES, Transparent	Polyethersulfone
Sealing	FKM	Fluoroelastomer
Cable gland	FKM	Fluoroelastomer
Dimensions	11 x 31.5 x 21 mm	
Weight	≤ 100 g	Cable version
	≤ 65 g	Plug version

Dimensions



Compatibility and conformity

Approvals and markings

General reference	Sensor designed according to EN60947-5-2	
MTTF_d	176.5 years @ 40°C (+104°F)	ISO 13849-1, SN 29500
CE-marking		
Approvals	 (UL508 + C22.2)	
Other Approvals		Topax 56, Topaz AC1, Topaz MD3, Topaz CL1, Topactiv OKTO, P3-hypochloran



References

Product selection key

PD30ETD02 A WE

Enter the code option instead of

Code	Option	Description
P	-	Photoelectric sensor
D	-	Rectangular housing
30	-	Length of housing
E	-	Stainless steel
T	-	Top trimmer
D	-	Diffuse reflective
02	-	Distance [dm]
<input type="checkbox"/>	N	NPN
	P	PNP
A	-	Output: N.O. and N.C.
<input type="checkbox"/>	-	Cable, 2 m
	M5	Connector M8
WE	-	Extreme wide angle

Type selection

Conne- ction	Output	Code
Cable	NPN	PD30ETD02NAWE
	PNP	PD30ETD02PAWE
Plug	NPN	PD30ETD02NAM5WE
	PNP	PD30ETD02PAM5WE



Delivery contents and accessories



Delivery contents

- Photoelectric switch: PD30ETD02...
- Screwdriver
- Packaging: Carton box
- Mounting bracket: APD30-MB1

Accessories

- Mounting bracket: APD30-MB2 to be purchased separately
- Connector type: CON.54NF..W series to be purchased separately

Further information

Information	Where to find it	QR
Mounting brackets	http://cga.pub/?6fa29a	
Connectors	http://cga.pub/?3abadc	



COPYRIGHT ©2022
 Content subject to change. Download the PDF: www.gavazziautomation.com