

BEW-TEMDIS

- Smart-house temperature controller with display
- Display current room temperature
- Display outdoor temperature
- Turn on/off heating and cooling
- Set wanted room/floor temperature
- Energy Save through night setback temperature
- Channel Programming using BGP-COD-BAT
- The use of floorsensor is optional
- Delivered with pre-programmed address on I/O 2



GENERAL SPECIFICATIONS

Channel programming	By BGP-COD-BAT
No. of channels	2 needed + 3 Optional
Channel assignment	I/O 1: Not programmed I/O 2: Pre-programmed to address B2 I/O 3: Not programmed I/O 4: Not programmed I/O 5: Not programmed
Housing	ELKO

Environment	
Degree of protection	IP 20
Operating temperature	0° to +50°C (32° to +122°F)
Storage temperature	-20° to +70°C (-4° to +158°F)
Humidity (Non condensing)	20 - 80%
Weight	50 g
Dimensions	
ELKO	86 x 86 x 24 mm
Max. wire in terminals	Max. 2 x 0.75 mm ²

SUPPLY SPECIFICATIONS

Power supply	Supplied by smart-house
Consumption	
LED OFF	< 0.5 mA
LED ON	< 1.2 mA

INPUT SPECIFICATIONS

Sensor	1 integrated temperature sensor
Range	0 - 50°C (32 - 122°F)
Precision	± 1°C
Floor sensor	
Temperature range	0 - 50°C (32 - 122°F)
Cable length	4 m
Cable consists of 4 wires:	
Brown	Connect to "+" on Temperature controller
White	Connect to "c" on Temperature controller
Yellow	Connect to "d" on Temperature controller
Green	Connect to "L" on Temperature controller
"See wiring diagram"	

TYPE SELECTION

Supply	Colour	Ordering no.
By smart-house	White	BEW-TEMDIS
	Grey	BEG-TEMDIS
	Antrasit	BEA-TEMDIS

The sensor is an electrical sensor and will only work together with the temperature controller unit.

WIRING DIAGRAM

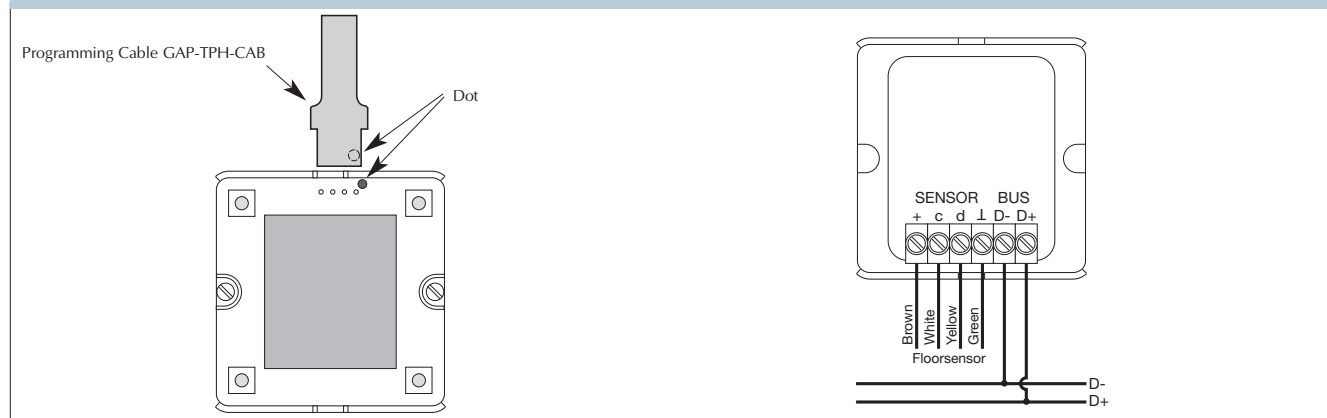

Mode of Operation

Channel Programming

Using the BGP-COD-BAT programming unit, each of the 5 channels on the temperature controller can be assigned any address between A1 and P8. The programming socket can be accessed by removing the front of the housing. The allocation of the channels are as follows:

I/O	Description
/ Needed I/Os	
1	Temperature Control / Split I/O
2	DataLink Synchronization input
Optional I/Os	
3	Room temperature Analink output
4	Floor temperature Analink output
5	Floor temperature Alarm. High temperature output

*** Note:** If a description of the heating/cooling outputs is required, please consult the manual for the smart-house controller BH8-CTRLZx-230. See paragraph 2.3.5

Please note that the unit can be programmed to both cooling and heating, but the mode required has to be selected on the display. For instance, cooling control can be selected during the summer and heating control during the winter.

The temperature controller works with both floor sensor and Room sensor. It is possible to enter the smart-house controller software to change / program which sensor is used (or both), together with the Temperature controller.

Symbol Description:

On the display the following **six** symbols are used:



– Temperature symbol 2 indicates that the outdoor temperature is currently shown on the display.



– Heat symbol, indicating that a heat application is currently selected. When the symbol is blinking, the unit is heating. When the symbol is steady, Heat mode is selected.



– Frost symbol, indicating that a cooling application is currently selected. When the symbol is blinking, the unit is cooling. When the symbol is steady, Cooling mode is selected.



– Sun symbol, indicating that the current application is running in normal mode.



– Moon symbol, indicating that the current application is running in night setback mode.

Note: When the temperature controller is in “normal” mode, the user is able to override this mode by selecting “night setback ☾” in the option menu.





– Frost protection

Starting Up



When the temperature controller is connected to the smart-house bus, the display digits will start flashing. The display will continue to flash until a complete status have been received from the smart-house controller. This will take approximately 1 min. When the temperature controller has received a complete status, the display will stop flashing and show the current application status and room or floor temperature.

Function Description

After the starting up has finished, normal operation will commence. In normal operation (Normal mode) the user has the following options:

Button	Description
	Show outdoor temperature
	Enter turn on/off menu
+	Enter adjust temperature set point menu
–	Enter adjust temperature set point menu

Outdoor temperature option

When pressing the  button the current outdoor temperature is shown in the display. A  symbol is also shown on the display to indicate outdoor temperature. The temperature controller will automatically go back to show the current room temperature (Normal mode) after the buttons have all been idle for approximately 5 seconds, or the user can single press the  button to exit.

***Note:** For this option to work correctly, an outdoor temperature sensor, BSI-TEMANA, must be connected to the smart-house bus and the option must be set up in the smart-house controller. If this is not done, the display will show 60.0 when this option is selected.

Option Menu

When pressing and holding the  button for ½ sec., the option menu for turning on/off heat, cooling etc. is selected. In this menu there are four possibilities:

1. Turn on/off Heating (heat symbol in the display).
2. Turn on/off Night setback for Heating applications (sun and moon symbols in the display).
3. Turn on/off Cooling (frost symbol in the display).
4. Turn on/off Night setback for Cooling applications (sun and moon symbols in the display)

When entering the option menu, the display will show with text what can be changed:

Nr.	Text in display	Description
1	HEAT	Heating can be turned on/off.
2	HES (Heat energy save/night setback)	Heat night setback can be turned on/off.
3	COOL	Cooling can be turned on/off.
4	CES (Cool energy save/night setback)	Cool night setback can be turned on/off.

To step through the four above possibilities single press the  button.

ELKO Temperature Controller



Option Menu (cont.)

Step 3:
+ or - used for selecting or de-selecting (see response in the form of symbols at the bottom of the display).

Step 2:
Single press the button for one of the four options.

Step 1:
Press the button 1 second to select the "option menu".

Symbols emerging at the top and bottom of the display.

Any changes made will take effect when all buttons have been idle for approximately 10 seconds or when the user single presses the power button.

Before any selection in the option mode can be made, a corresponding program in the smart-house controller must be programmed first.

* **Note:** If a heating application is selected in the smart-house controller, it is only possible to turn on/off heat and night setback for heat. The same applies if a cooling application is selected. In this case it is only possible to turn on/off cool and night setback for cooling.

* **Note:** When a cooling application is running, cool will not be turned on automatically. The user must turn on the cooling by entering the turn on/off menu.

Setpoint Menu

Step 1:
Press + or - to enter "Set point menu"

Step 2:
Single press the button to the option required.

Step 3:
Press + or - to select the required setpoint value. Press power or wait for 5 seconds and the values will be stored.

The symbols at the display will confirm entering set-point menu by blinking.

The symbols at the bottom of the display indicate which set-point that has been selected:

- setpoint for heating
- setpoint for night setback heating
- setpoint for cooling
- setpoint for night setback cooling

* **Note:** If only a heating application is configured in the smart-house controller, it is possible to select only heating and night setback in the temperature controller. If both heating and cooling is configured in the smart-house controller, both modes can be accessed in the temperature controller.

DIMENSIONS

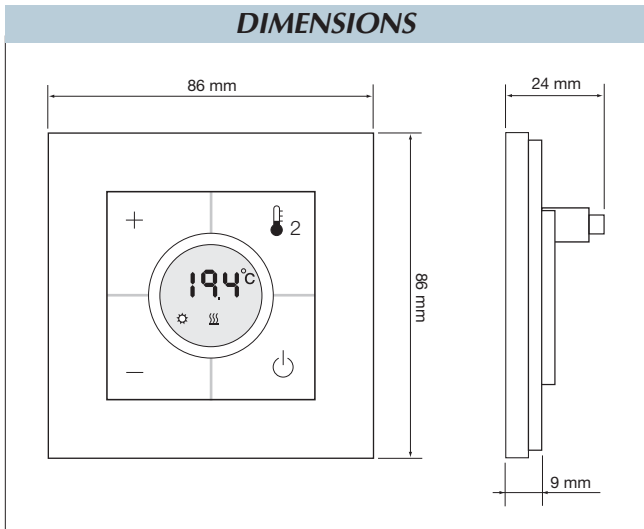

ACCESSORIES

- | | |
|----------------------------------|-------------|
| Programming cable to BGP-COD-BAT | GAP-TPH-CAB |
| Floor sensor | BSO-TEMDIG |