



Electric Automation
Automation specialists

Riferimento: AW 55 21 VA4571
Codice: 6418557

Supporto a muro e supporto con piastra di testa saldata, B210mm, acciaio inossidabile, grado 316 Ti, VA, 1.4571

Acquista da [Electric Automation Network](#)

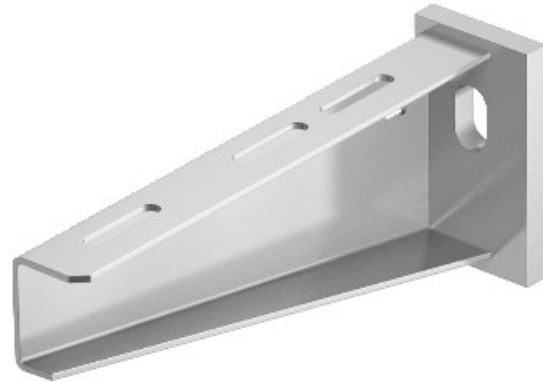

Heavy-duty a parete e staffa di supporto con saldato piastra di testa.