



**Electric Automation**  
Automation specialists

Riferimento: RBM 90 160 FT  
Codice: 6041870

Curva 90 °, con connessione veloce,  
110x600, zincatura a caldo, DIN EN ISO  
1461 Acciaio St

Acquista da [Electric Automation Network](#)

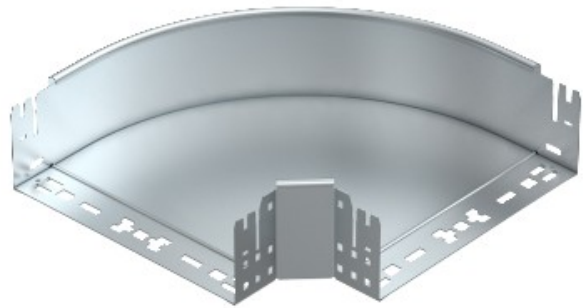

Curva a 90° con attacco rapido del sistema. Per tutti i tipi di supporti per cavi di 110 mm altezza laterale.