



**Electric Automation**  
Automation specialists

Riferimento: RBM 90 150 FS  
Codice: 6041848

Curva 90 °, con connessione veloce,  
110x500, banda zincato, DIN EN 10147,  
Acciaio, St

Acquista da [Electric Automation Network](#)

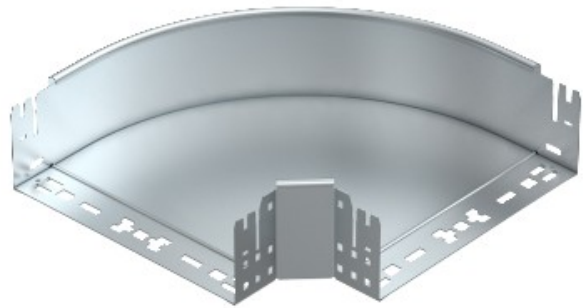

Curva a 90° con attacco rapido del sistema. Per tutti i tipi di supporti per cavi di 110 mm altezza laterale.