



Electric Automation
Automation specialists

Riferimento: RBM 90 115 FS
Codice: 6041841

Curva 90 °, con connessione veloce,
110x150, banda zincato, DIN EN 10147,
Acciaio, St

Acquista da [Electric Automation Network](#)

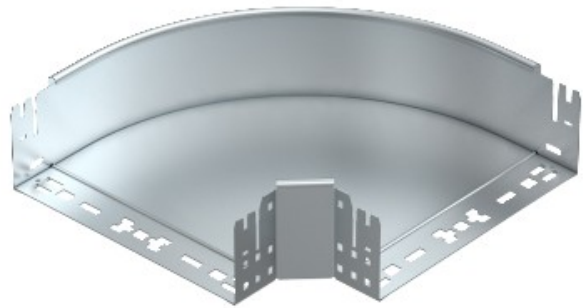

Curva a 90° con attacco rapido del sistema. Per tutti i tipi di supporti per cavi di 110 mm altezza laterale.