



Electric Automation
Automation specialists

Artikel-Nr.: GRM 35 300 G
Code: 6000066

Gitterrinne GRM, 35x300x3000,
galvanisch, DIN 50961, Stahl, St

[Kaufen von Electric Automation Network](#)

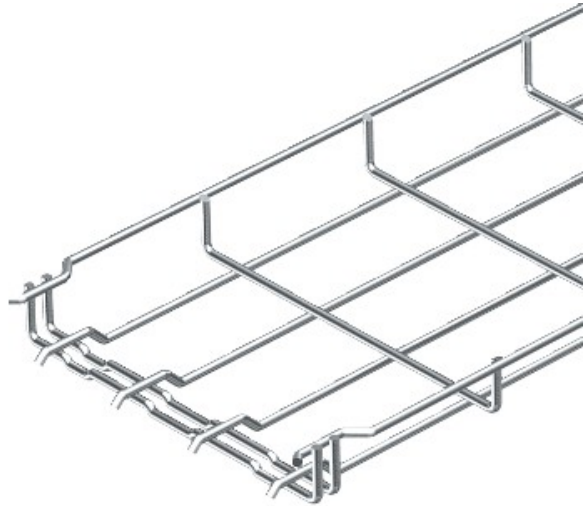

Magnetische Abschirmung Isolierung ohne Deckel 15 dB, mit Deckel 25 dB.