



Automatización Eléctrica
Especialistas en Automatización

At the end of this document you will find links to products related to this catalog. You can go directly to our shop by clicking [HERE](#). [HERE](#)

Plug - PP-H 4/ 4 - 3212029

Please be informed that the data shown in this PDF Document is generated from our Online Catalog. Please find the complete data in the user's documentation. Our General Terms of Use for Downloads are valid (<http://phoenixcontact.com/download>)



Plug, Connection method: Push-in / plug connection, Number of positions: 4, Cross section: 0.2 mm² - 6 mm², AWG: 24 - 10, Width: 24.8 mm, Height: 42.3 mm, Color: gray

The figure shows a version of the article

Why buy this product

- Large-surface labeling option
- The Push-in technology COMBI plugs for self-assembly provide solutions that users can implement themselves
- Tested for railway applications

Key Commercial Data

Packing unit	50 STK
GTIN	 4 046356 483087

Technical data

General

Number of levels	1
Number of connections	4
Nominal cross section	4 mm ²
Color	gray
Insulating material	PA
Flammability rating according to UL 94	V0
Area of application	Railway industry
	Mechanical engineering
	Plant engineering
Rated surge voltage	8 kV
Degree of pollution	3
Overvoltage category	III
Insulating material group	I
Connection in acc. with standard	IEC 61984
Maximum load current	32 A (with 6 mm ² conductor cross section)
Nominal current I _N	32 A

Plug - PP-H 4/ 4 - 3212029

Technical data

General

Nominal voltage U_N	800 V
Open side panel	No
Number of positions	4

Dimensions

Width	24.8 mm
Length	21 mm
Height	42.3 mm
	24.00 mm

Connection data

Connection method	Push-in / plug connection
Connection in acc. with standard	IEC 61984
Conductor cross section solid min.	0.2 mm ²
Conductor cross section solid max.	6 mm ²
Conductor cross section AWG min.	24
Conductor cross section AWG max.	10
Conductor cross section flexible min.	0.2 mm ²
Conductor cross section flexible max.	4 mm ²
Min. AWG conductor cross section, flexible	24
Max. AWG conductor cross section, flexible	12
Conductor cross section flexible, with ferrule without plastic sleeve min.	0.25 mm ²
Conductor cross section flexible, with ferrule without plastic sleeve max.	4 mm ²
Conductor cross section flexible, with ferrule with plastic sleeve min.	0.25 mm ²
Conductor cross section flexible, with ferrule with plastic sleeve max.	4 mm ²
2 conductors with same cross section, stranded, TWIN ferrules with plastic sleeve, min.	0.5 mm ²
2 conductors with same cross section, stranded, TWIN ferrules with plastic sleeve, max.	1 mm ²
Stripping length	10 mm ... 12 mm
Internal cylindrical gage	A4

Standards and Regulations

Connection in acc. with standard	CUL
	IEC 61984
Flammability rating according to UL 94	V0

Classifications

eCl@ss

eCl@ss 4.0	272607xx
eCl@ss 4.1	27260701
eCl@ss 5.0	27260701

Plug - PP-H 4/ 4 - 3212029

Classifications

eCl@ss

eCl@ss 5.1	27260701
eCl@ss 6.0	27141151
eCl@ss 7.0	27141151
eCl@ss 8.0	27141151

ETIM

ETIM 4.0	EC002021
ETIM 5.0	EC002021

UNSPSC

UNSPSC 6.01	30211802
UNSPSC 7.0901	39121402
UNSPSC 11	39121402
UNSPSC 12.01	39121402
UNSPSC 13.2	39121402

Approvals

Approvals

Approvals

UL Recognized / cUL Recognized / GL / LR / EAC / BV / cULus Recognized

Ex Approvals

Approvals submitted

Approval details

UL Recognized 		
	B	C
mm ² /AWG/kcmil	24-10	24-10
Nominal current I _N	28 A	28 A
Nominal voltage U _N	600 V	600 V

Plug - PP-H 4/ 4 - 3212029

Approvals

cUL Recognized		
	B	C
mm ² /AWG/kcmil	24-10	24-10
Nominal current I _N	28 A	28 A
Nominal voltage U _N	600 V	600 V
GL		
LR		
EAC		
BV		
cULus Recognized		

Drawings

Circuit diagram



Diagram

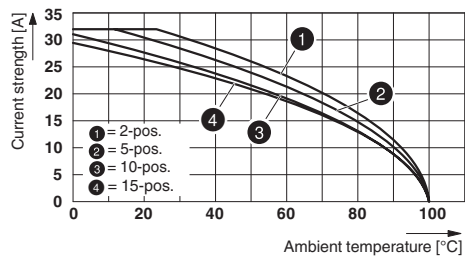

Plug - PP-H 4/ 4 - 3212029

Schematic diagram

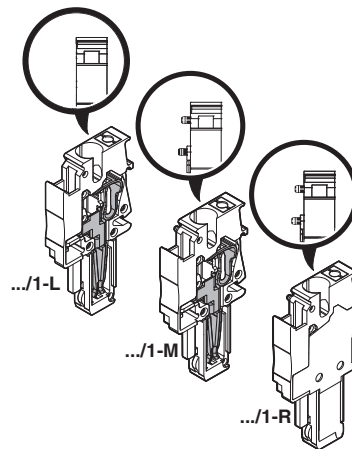

Phoenix Contact 2016 © - all rights reserved
<http://www.phoenixcontact.com>

PHOENIX CONTACT GmbH & Co. KG
Flachsmarktstr. 8
32825 Blomberg
Germany
Tel. +49 5235 300
Fax +49 5235 3 41200
<http://www.phoenixcontact.com>



Automatización Eléctrica
Especialistas en Automatización

Below is a list of articles with direct links to our shop Electric Automation Network where you can see:

- Quote per purchase volume in real time.
- Online documentation and datasheets of all products.
- Estimated delivery time enquiry in real time.
- Logistics systems for the shipment of materials almost anywhere in the world.
- Purchasing management, order record and tracking of shipments.

To access the product, [click on the green button.](#)

Product	Code	Reference	Product link
Plug, Connection method: Push-in / plug connection, Number of positions: 4, Cross section: 0.2 mm ² - 6 mm ² , AWG: 24 - 10, Width: 24.8 mm, Height: 42.3 mm, Color: gray	3212029	PP-H 4/ 4	Buy on EAN