



Automatización Eléctrica
Especialistas en Automatización

At the end of this document you will find links to products related to this catalog. You can go directly to our shop by clicking [HERE](#). [HERE](#)

Relay Module - PLC-RPT- 12DC/21-21 - 2900329

Please be informed that the data shown in this PDF Document is generated from our Online Catalog. Please find the complete data in the user's documentation. Our General Terms of Use for Downloads are valid (<http://phoenixcontact.com/download>)



PLC-INTERFACE, consisting of PLC-BPT.../21-21 basic terminal block with push-in connection and plug-in miniature relay with power contact, for mounting on NS 35/7,5 DIN rail, 2 PDTs, input voltage 12 V DC

The figure shows a version with a screw connection

Why buy this product

- Slim design
- Efficient connection to system cabling using V8 adapter
- Safe isolation according to DIN EN 50178 between coil and contact
- RT III sealed relay
- Functional plug-in bridges
- Integrated input circuit and interference suppression circuit



Key Commercial Data

Packing unit	10 STK
GTIN	 4 046356 507196

Technical data

Note

Utilization restriction	EMC: class A product, see manufacturer's declaration in the download area
-------------------------	---

Dimensions

Width	14 mm
Height	80 mm
Depth	94 mm

Ambient conditions

Ambient temperature (operation)	-40 °C ... 60 °C
Ambient temperature (storage/transport)	-40 °C ... 85 °C

Relay Module - PLC-RPT- 12DC/21-21 - 2900329

Technical data

Coil side

Nominal input voltage U_N	12 V DC
Typical input current at U_N	33 mA
Typical response time	8 ms
Typical release time	10 ms
Protective circuit	Protection against polarity reversal Polarity protection diode
	Free-wheeling diode Damping diode
Operating voltage display	Yellow LED
Power dissipation for nominal condition	0.4 W

Contact side

Contact type	2 PDT
Contact material	AgNi
Maximum switching voltage	250 V AC/DC (The separating plate PLC-ATP should be installed for voltages larger than 250 V (L1, L2, L3) between identical terminal blocks in adjacent modules. Potential bridging is then carried out with FBST 8-PLC... or ...FBST 500...)
Minimum switching voltage	5 V AC/DC (at 10 mA)
Min. switching current	10 mA (At 5 V)
Maximum inrush current	15 A (300 ms)
Limiting continuous current	6 A
Interrupting rating (ohmic load) max.	140 W (at 24 V DC)
	85 W (at 48 V DC)
	60 W (at 60 V DC)
	44 W (at 110 V DC)
	60 W (at 220 V DC)
	1500 VA (for 250 V AC)
Switching capacity in acc. with DIN VDE 0660/IEC 60947	2 A (at 24 V, DC13)
	0.2 A (at 250 V, DC13)
	3 A (at 24 V, AC15)
	3 A (at 120 V, AC15)
	3 A (at 250 V, AC15)

Connection data input side

Connection name	Coil side
Connection method	Push-in connection
Stripping length	8 mm
Conductor cross section solid	0.14 mm ² ... 2.5 mm ²
Conductor cross section flexible	0.14 mm ² ... 2.5 mm ²
Conductor cross section AWG	26 ... 14

Connection data output side

Connection name	Contact side
Connection method	Push-in connection

Relay Module - PLC-RPT- 12DC/21-21 - 2900329

Technical data

Connection data output side

Stripping length	8 mm
Conductor cross section solid	0.14 mm ² ... 2.5 mm ²
Conductor cross section flexible	0.14 mm ² ... 2.5 mm ²
Conductor cross section AWG	26 ... 14

General

Operating mode	100% operating factor
Degree of protection	RT III (Relay)
Mechanical service life	3 x 10 ⁷ cycles
Flammability rating according to UL 94	V0
Designation	Standards/regulations
Standards/regulations	IEC 60664
	EN 50178
	IEC 62103
Rated surge voltage/insulation	6 kV (safe isolation: control side / contact side)
Degree of pollution	2
Overvoltage category	III
Mounting position	any
Assembly instructions	In rows with zero spacing

Standards and Regulations

Connection in acc. with standard	CUL
Designation	Standards/regulations
Standards/regulations	IEC 60664
	EN 50178
	IEC 62103
Rated surge voltage/insulation	6 kV (safe isolation: control side / contact side)
Degree of pollution	2
Overvoltage category	III
Flammability rating according to UL 94	V0

Articles in set

Relay socket - PLC-BPT- 12DC/21-21 - 2900282



14 mm PLC basic terminal block with push-in connection, without relay or solid-state relay, for mounting on DIN rail NS 35/7,5, 2 PDTs, input voltage 12 V DC

Relay Module - PLC-RPT- 12DC/21-21 - 2900329

Articles in set

Single relay - REL-MR- 12DC/21-21 - 2961257



Plug-in miniature power relay, with power contact, 2 PDTs, input voltage 12 V DC

Classifications

eCl@ss

eCl@ss 4.0	27371001
eCl@ss 4.1	27371001
eCl@ss 5.0	27371001
eCl@ss 5.1	27371001
eCl@ss 6.0	27371001
eCl@ss 7.0	27371001
eCl@ss 8.0	27371601
eCl@ss 9.0	27371601

ETIM

ETIM 4.0	EC000196
ETIM 5.0	EC001437

UNSPSC

UNSPSC 6.01	30211916
UNSPSC 7.0901	39121515
UNSPSC 11	39121515
UNSPSC 12.01	39121515
UNSPSC 13.2	39121515

Approvals

Approvals

Approvals

GL / UL Listed / cUL Listed / UL Recognized / cUL Recognized / EAC / RC FRT / EAC / cULus Recognized / cULus Listed

Ex Approvals

Approvals submitted

Relay Module - PLC-RPT- 12DC/21-21 - 2900329

Approvals

Approval details

GL

UL Listed 

cUL Listed 

UL Recognized 

cUL Recognized 

EAC

RC FRT

EAC

cULus Recognized  US

cULus Listed  US

Drawings

Relay Module - PLC-RPT- 12DC/21-21 - 2900329

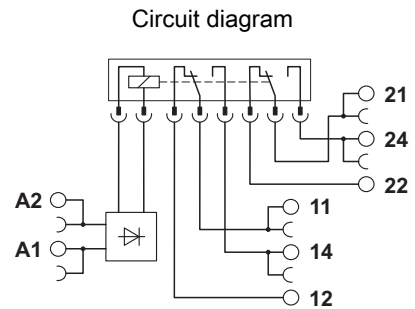
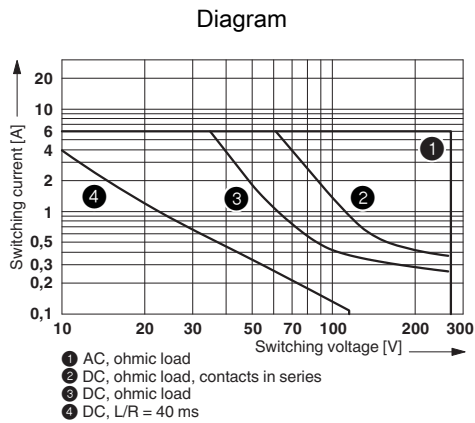

Interrupting rating

Diagram

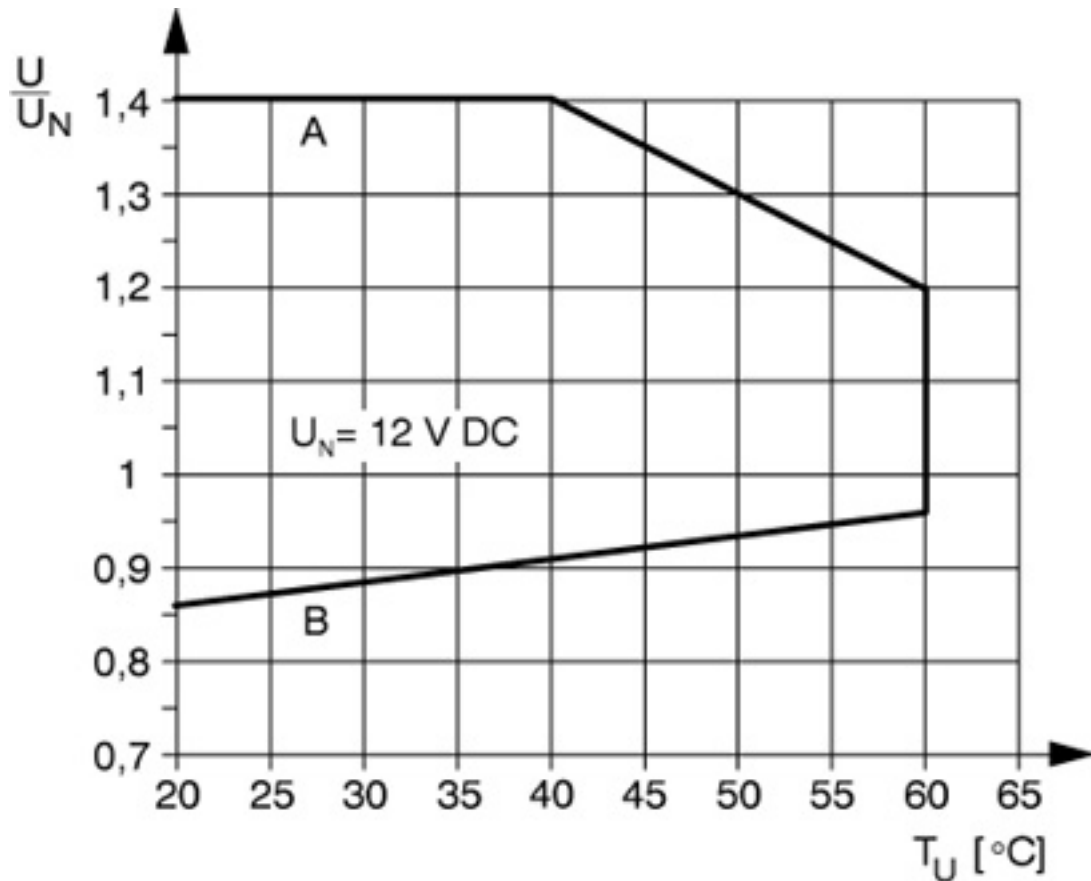

Curve A

Maximum permissible continuous voltage U_{max} with limiting continuous current on the contact side (see relevant technical data)

Curve B

Minimum permissible operate voltage U_{op} after pre-excitation (see relevant technical data)

Phoenix Contact 2016 © - all rights reserved
<http://www.phoenixcontact.com>

PHOENIX CONTACT GmbH & Co. KG
Flachsmarktstr. 8
32825 Blomberg
Germany
Tel. +49 5235 300
Fax +49 5235 3 41200
<http://www.phoenixcontact.com>



Automatización Eléctrica
Especialistas en Automatización

Below is a list of articles with direct links to our shop Electric Automation Network where you can see:

- Quote per purchase volume in real time.
- Online documentation and datasheets of all products.
- Estimated delivery time enquiry in real time.
- Logistics systems for the shipment of materials almost anywhere in the world.
- Purchasing management, order record and tracking of shipments.

To access the product, [click on the green button.](#)

Product	Code	Reference	Product link
PLC-INTERFACE, consisting of PLC-BPT../21-21 basic terminal block with push-in connection and plug-in miniature relay with power contact, for mounting on NS 35/7,5 DIN rail, 2 PDTs, input voltage 12 V DC	2900329	PLC-RPT-12DC/21-21	Buy on EAN