



Automatización Eléctrica
Especialistas en Automatización

At the end of this document you will find links to products related to this catalog. You can go directly to our shop by clicking [HERE](#). [HERE](#)

Thermomagnetic device circuit breaker - CB TM2 2A SFB P - 2800870

Please be informed that the data shown in this PDF Document is generated from our Online Catalog. Please find the complete data in the user's documentation. Our General Terms of Use for Downloads are valid (<http://phoenixcontact.com/download>)



Thermomagnetic device circuit breaker, 2-pos., tripping characteristic SFB, 2 PDT contacts, plug for base element.

The figure shows the CB TM2 0.5A SFB P version

Product Description

Thermomagnetic device circuit breaker

Key Commercial Data

Packing unit	1 STK
GTIN	 4 046356 690355

Technical data

Dimensions

Height	45 mm
Width	24.6 mm
Depth	52 mm

Ambient conditions

Ambient temperature (operation)	-30 °C ... 60 °C
Ambient temperature (storage/transport)	-40 °C ... 80 °C
Humidity test	240 h, 95% RH, 40°C
Shock (operation)	30g (IEC 60068-2-27, Test Ea)
Degree of protection	IP30 (Actuation area)

General

Installation instructions	When mounted in rows, the nominal device current can be limited to just 80% or must be overdimensioned accordingly.
Flammability rating according to UL 94	V0
Mounting type	On base element
Color	gray
Number of positions	2
Insulating material group	II
Degree of pollution	2

Thermomagnetic device circuit breaker - CB TM2 2A SFB P - 2800870

Technical data

Electrical data

Fuse type	SFB
Rated surge voltage	2.5 kV (Increased insulation in actuation area)
	80 V DC (IEC 60934)
	80 V DC (UL 1077)
	80 V DC (UL 508 - with plug-in base)
Rated current I_N	2 A (IEC 60934)
	inductive load according to UL 1077
	2 A DC (low-induction load according to UL 1077)
	2 A DC (inductive load according to UL 508 - with plug-in base)
	2 A DC (low-induction load according to UL 508 - with plug-in base)
Rated insulation voltage U_i	277 V AC (UL 1077)
	250 V AC (IEC 60934)
Required backup fuse	≥ 15 A
Contact type	2 PDT
Power dissipation	1.2 W (in nominal operation per channel)
Insulation resistance R_{iso}	> 100 M Ω (500 V DC)
Type of actuation	S type
Tripping method	TM (thermomagnetic)
Tripping level	Trip-free mechanism (positive)
	600 A (80 V DC)
Short-circuit switching capacity I_k	1000 A AC 277 V AC
	1000 A DC 50 V DC
Dielectric strength	3000 V AC (Actuation area)
	1500 V AC (Main to auxiliary circuit)
	1500 V AC (Open main circuit)
	1000 V AC (Open auxiliary circuit)
	1500 V AC (Position to position)
Voltage drop	0.64 V (at $1 \times I_N$)
Switching cycles, max.	6000 (240 V AC/ $1 \times I_N$)
	3000 (80 V DC/ $1 \times I_N$)
Contact type	2 PDT
Auxiliary circuit	277 V AC / 0.5 A (Low-induction)
	277 V AC / 1 A (Low-induction, maximum of 2000 cycles)
	50 V DC / 1 A (Low-induction)
Minimum auxiliary contact operating voltage	10 V
Maximum auxiliary contact operating voltage	240 V
	240 V
Minimum auxiliary contact operating current	10 mA
Maximum auxiliary contact operating current	1 A
Vibration resistance, frequency	57 Hz ... 500 Hz

Thermomagnetic device circuit breaker - CB TM2 2A SFB P - 2800870

Technical data

Electrical data

Vibration resistance, amplitude	0.61 mm (10 - 57 Hz)
Vibration resistance, acceleration	80 m/s ²
Vibration resistance, test duration	10 (Frequency cycles/axis)

Standards and Regulations

Standards/specifications	EN 60934
	UL 1077 UL/C-UL recognized
	UL 508 UL/C - UL listed
	CSA 22.2 No. 235-041

Classifications

eCl@ss

eCl@ss 4.0	27141116
eCl@ss 4.1	27141116
eCl@ss 5.0	27141116
eCl@ss 5.1	27141116
eCl@ss 6.0	27141116
eCl@ss 7.0	27141116
eCl@ss 8.0	27141116

ETIM

ETIM 3.0	EC000899
ETIM 4.0	EC000899
ETIM 5.0	EC000899

UNSPSC

UNSPSC 6.01	30211812
UNSPSC 7.0901	39121411
UNSPSC 11	39121411
UNSPSC 12.01	39121411
UNSPSC 13.2	39121411

Approvals

Approvals

Approvals

VDE Zeichengenehmigung / UL Recognized / cUL Recognized / GL / EAC / CSA / cULus Recognized

Ex Approvals

Thermomagnetic device circuit breaker - CB TM2 2A SFB P - 2800870

Approvals

Approvals submitted

Approval details

VDE Zeichengenehmigung

UL Recognized

cUL Recognized

GL

EAC

CSA

cULus Recognized

Drawings

Dimensional drawing

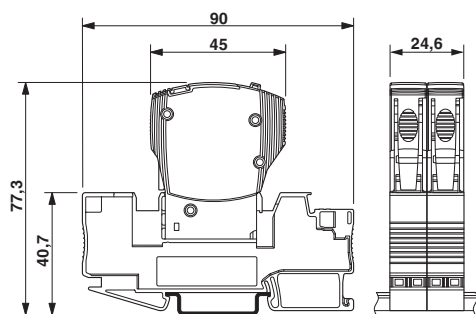

The figure shows the complete module consisting of a base element and connector

Diagram

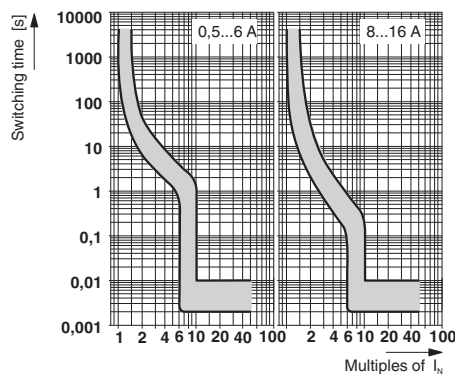

Trigger characteristic in the DC range

Thermomagnetic device circuit breaker - CB TM2 2A SFB P - 2800870

Application drawing

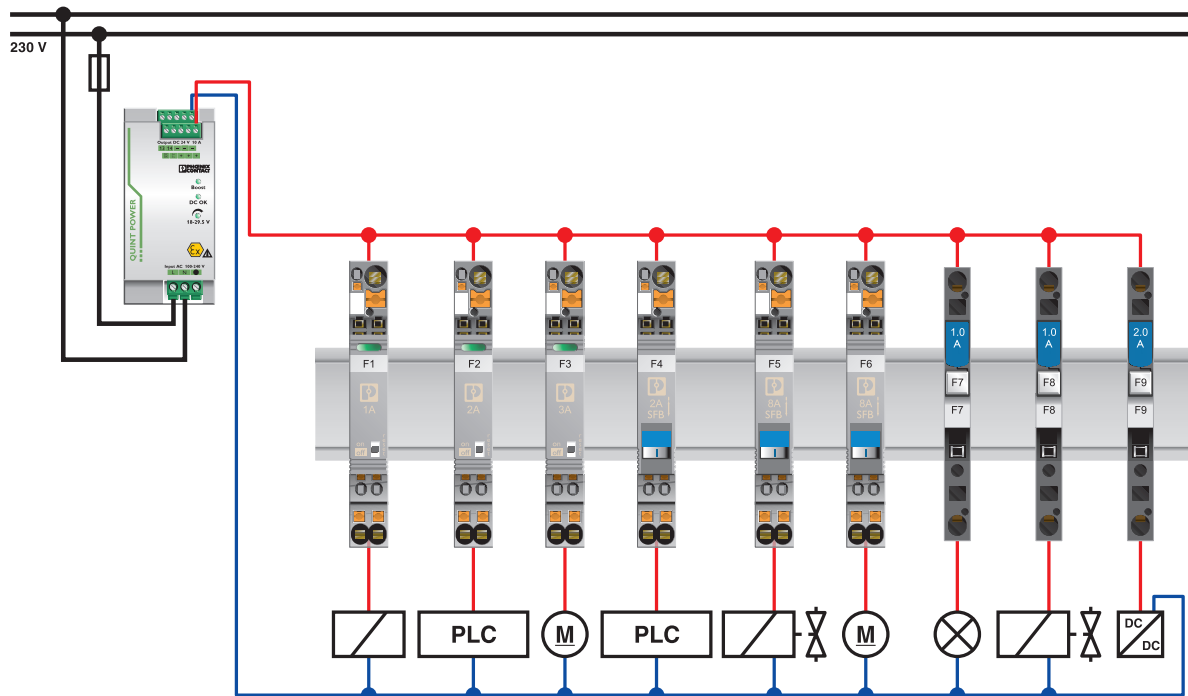

The figure shows the single-position versions

Phoenix Contact 2016 © - all rights reserved
<http://www.phoenixcontact.com>

PHOENIX CONTACT GmbH & Co. KG
Flachsmarktstr. 8
32825 Blomberg
Germany
Tel. +49 5235 300
Fax +49 5235 3 41200
<http://www.phoenixcontact.com>



Automatización Eléctrica
Especialistas en Automatización

Below is a list of articles with direct links to our shop Electric Automation Network where you can see:

- Quote per purchase volume in real time.
- Online documentation and datasheets of all products.
- Estimated delivery time enquiry in real time.
- Logistics systems for the shipment of materials almost anywhere in the world.
- Purchasing management, order record and tracking of shipments.

To access the product, [click on the green button.](#)

Product	Code	Reference	Product link
Thermomagnetic device circuit breaker, 2-pos., tripping characteristic SFB, 2 PDT contacts, plug for base element.	2800870	CB TM2 2A SFB P	Buy on EAN