



**Automatización Eléctrica**  
Especialistas en Automatización

At the end of this document you will find links to products related to this catalog. You can go directly to our shop by clicking [HERE](#). [HERE](#)

# Printed-circuit board connector - CCV 2,5/ 4-GF-5,08 P26THRR56 - 1955769

Please be informed that the data shown in this PDF Document is generated from our Online Catalog. Please find the complete data in the user's documentation. Our General Terms of Use for Downloads are valid (<http://phoenixcontact.com/download>)



Header, Nominal current: 12 A, Rated voltage (III/2): 320 V, Number of positions: 4, Pitch: 5.08 mm, Color: black, Contact surface: Tin, Mounting: THR soldering, User information and design recommendations for through hole reflow technology can be found under "Downloads"

## Why buy this product

- Standard pin length of 2.6 mm, other pin lengths available on request
- Plug-in direction vertical to the PCB
- Use in SMT reflow processes

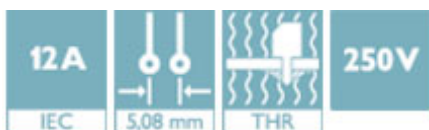

## Key Commercial Data

Packing unit	140 STK
Minimum order quantity	140 STK
GTIN	 4 017918 926526

## Technical data

### Dimensions

Length	8.6 mm
Pitch	5.08 mm
Dimension a	15.24 mm
Constructional height	13 mm
Height	12 mm
Length of the solder pin	2.6 mm
Pin dimensions	1 x 1 mm
Hole diameter	1.6 mm

### General

Range of articles	CCV 2,5/...-GF
Insulating material group	IIIa

# Printed-circuit board connector - CCV 2,5/ 4-GF-5,08 P26THRR56 - 1955769

## Technical data

### General

Rated surge voltage (III/3)	4 kV
Rated surge voltage (III/2)	4 kV
Rated surge voltage (II/2)	4 kV
Rated voltage (III/3)	250 V
Rated voltage (III/2)	320 V
Rated voltage (II/2)	400 V
Connection in acc. with standard	EN-VDE
Nominal current I <sub>N</sub>	12 A
Maximum load current	12 A (per position)
Insulating material	LCP
Flammability rating according to UL 94	V0
Color	black
Number of positions	4

### Standards and Regulations

Connection in acc. with standard	EN-VDE
	CUL
Flammability rating according to UL 94	V0

### Classifications

#### eCl@ss

eCl@ss 4.0	272607xx
eCl@ss 4.1	27260701
eCl@ss 5.0	27260701
eCl@ss 5.1	27260701
eCl@ss 6.0	27260704
eCl@ss 7.0	27440402
eCl@ss 8.0	27440402
eCl@ss 9.0	27440402

#### ETIM

ETIM 3.0	EC001121
ETIM 4.0	EC002637
ETIM 5.0	EC002637

#### UNSPSC

UNSPSC 6.01	30211810
UNSPSC 7.0901	39121409
UNSPSC 11	39121409

# Printed-circuit board connector - CCV 2,5/ 4-GF-5,08 P26THRR56 - 1955769

## Classifications

### UNSPSC

UNSPSC 12.01	39121409
UNSPSC 13.2	39121409

## Approvals

### Approvals

#### Approvals

EAC / VDE Gutachten mit Fertigungsüberwachung / IECCEB Scheme / cULus Recognized

#### Ex Approvals

#### Approvals submitted

## Approval details

EAC

VDE Gutachten mit Fertigungsüberwachung 	
Nominal current I <sub>N</sub>	12 A
Nominal voltage U <sub>N</sub>	400 V

IECEE CB Scheme 

cULus Recognized

## Drawings

# Printed-circuit board connector - CCV 2,5/ 4-GF-5,08 P26THRR56 - 1955769

Dimensional drawing

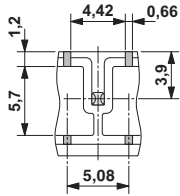

Drilling diagram

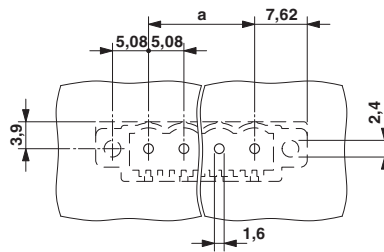

Bottom view, free space for solder paste, 0.55 mm deep

Dimensional drawing

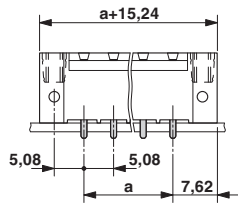
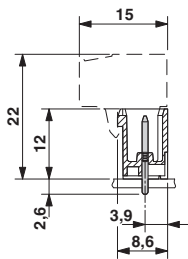

Dimensional drawing

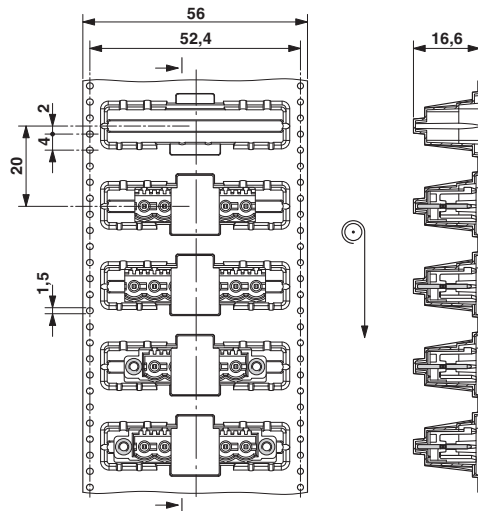

Direction of the arrow = feeding direction

Dimensional drawing

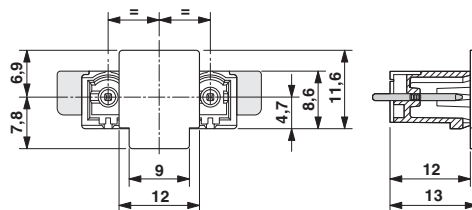

Phoenix Contact 2016 © - all rights reserved  
<http://www.phoenixcontact.com>

PHOENIX CONTACT GmbH & Co. KG  
Flachmarktstr. 8  
32825 Blomberg  
Germany  
Tel. +49 5235 300  
Fax +49 5235 3 41200  
<http://www.phoenixcontact.com>



Below is a list of articles with direct links to our shop Electric Automation Network where you can see:

- Quote per purchase volume in real time.
- Online documentation and datasheets of all products.
- Estimated delivery time enquiry in real time.
- Logistics systems for the shipment of materials almost anywhere in the world.
- Purchasing management, order record and tracking of shipments.

To access the product, [click on the green button.](#)

Product	Code	Reference	Product link
Header, Nominal current: 12 A, Rated voltage (III/2): 320 V, Number of positions: 4, Pitch: 5.08 mm, Color: black, Contact surface: Tin, Mounting: SMD/THT/THR, User information and design recommendations for through hole reflow technology can be found under "Downloads"	1955769	CCV 2,5/ 4-GF-5,08 P26THRR56	<a href="#">Buy on EAN</a>