



Automatización Eléctrica
Especialistas en Automatización

At the end of this document you will find links to products related to this catalog. You can go directly to our shop by clicking [HERE](#). [HERE](#)

Printed-circuit board connector - MC 0,5/12-G-2,5 THT - 1939316

Please be informed that the data shown in this PDF Document is generated from our Online Catalog. Please find the complete data in the user's documentation. Our General Terms of Use for Downloads are valid (<http://phoenixcontact.com/download>)

Header, Nominal current: 4 A, Rated voltage (III/2): 160 V, Number of positions: 12, Pitch: 2.5 mm, Color: black, Contact surface: Tin, Mounting: THR soldering, User information and design recommendations for through hole reflow technology can be found under "Downloads"



The figure shows a 10-position version of the product

Why buy this product

- Alternative pin lengths of 1.4 mm or 2.6 mm available on request
- Reel diameter: 330 mm, tape width: 44 mm
- Low-profile THR pin strips with a compact MICRO pitch of 2.5 mm
- Delivery form: box packaging, in bulk for small series
- Delivery form: tape-on-reel packing according to IEC 60286-3 for automated mounting
- Use in SMT reflow processes

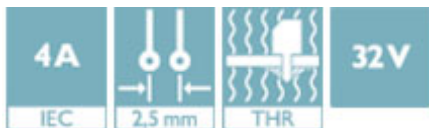

Key Commercial Data

Packing unit	50 STK
Minimum order quantity	50 STK
GTIN	 4 017918 849764

Technical data

Dimensions

Length	10.1 mm
Pitch	2.50 mm
Dimension a	27.5 mm
Constructional height	9 mm
Height	8.1 mm
Length of the solder pin	3.8 mm
Pin dimensions	0,8 x 0,8 mm
Pin spacing	2.50 mm
Hole diameter	1.4 mm

Printed-circuit board connector - MC 0,5/12-G-2,5 THT - 1939316

Technical data

General

Range of articles	MC 0,5/...-G-THT
Insulating material group	IIIa
Rated surge voltage (III/3)	1.5 kV
Rated surge voltage (III/2)	2.5 kV
Rated surge voltage (II/2)	2.5 kV
Rated voltage (III/3)	32 V
Rated voltage (III/2)	160 V
Rated voltage (II/2)	160 V
Connection in acc. with standard	EN-VDE
Nominal current I _N	4 A
Maximum load current	4 A
Insulating material	PA
Flammability rating according to UL 94	V0
Color	black
Number of positions	12

Standards and Regulations

Connection in acc. with standard	EN-VDE
	CUL
Flammability rating according to UL 94	V0

Classifications

eCl@ss

eCl@ss 4.0	272607xx
eCl@ss 4.1	27260701
eCl@ss 5.0	27260701
eCl@ss 5.1	27260701
eCl@ss 6.0	27260704
eCl@ss 7.0	27440402
eCl@ss 8.0	27440402
eCl@ss 9.0	27440402

ETIM

ETIM 3.0	EC001121
ETIM 4.0	EC002637
ETIM 5.0	EC002637

UNSPSC

UNSPSC 6.01	30211810
UNSPSC 7.0901	39121409
UNSPSC 11	39121409

Printed-circuit board connector - MC 0,5/12-G-2,5 THT - 1939316

Classifications

UNSPSC

UNSPSC 12.01	39121409
UNSPSC 13.2	39121409

Approvals

Approvals

Approvals

UL Recognized / VDE Gutachten mit Fertigungsüberwachung / cUL Recognized / IECCE CB Scheme / CCA / cULus Recognized

Ex Approvals

Approvals submitted

Approval details

UL Recognized 	
	B
Nominal current IN	4 A
Nominal voltage UN	125 V

VDE Gutachten mit Fertigungsüberwachung 	
Nominal current IN	4 A
Nominal voltage UN	32 V

cUL Recognized 	
	B
Nominal current IN	4 A
Nominal voltage UN	125 V

Printed-circuit board connector - MC 0,5/12-G-2,5 THT - 1939316

Approvals

IECEE CB Scheme	
Nominal current I_N	4 A
Nominal voltage U_N	32 V

CCA	
Nominal current I_N	4 A
Nominal voltage U_N	32 V

cULus Recognized	
------------------	--

Drawings

Dimensional drawing

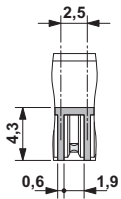

Drilling diagram

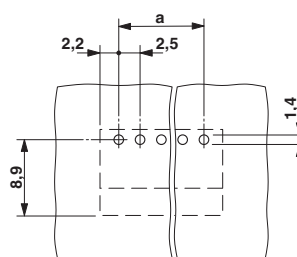

Printed-circuit board connector - MC 0,5/12-G-2,5 THT - 1939316

Dimensional drawing

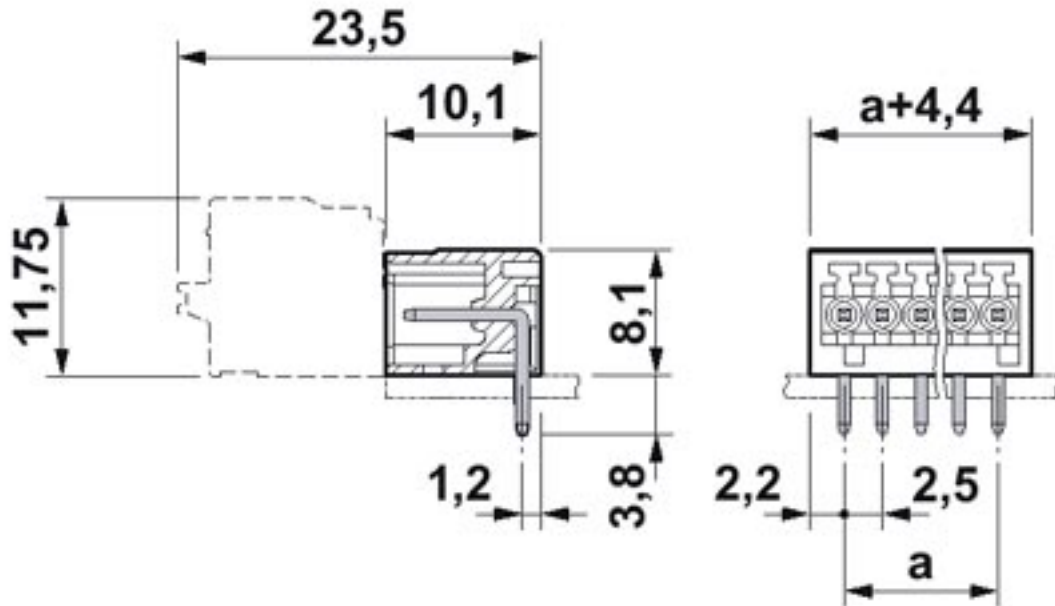

Phoenix Contact 2016 © - all rights reserved
<http://www.phoenixcontact.com>

PHOENIX CONTACT GmbH & Co. KG
Flachsmarktstr. 8
32825 Blomberg
Germany
Tel. +49 5235 300
Fax +49 5235 3 41200
<http://www.phoenixcontact.com>

Below is a list of articles with direct links to our shop Electric Automation Network where you can see:

- Quote per purchase volume in real time.
- Online documentation and datasheets of all products.
- Estimated delivery time enquiry in real time.
- Logistics systems for the shipment of materials almost anywhere in the world.
- Purchasing management, order record and tracking of shipments.

To access the product, [click on the green button.](#)

Product	Code	Reference	Product link
Header, Nominal current: 4 A, Rated voltage (III/2): 160 V, Number of positions: 12, Pitch: 2.5 mm, Color: black, Contact surface: Tin, Mounting: SMD/THT/THR, User information and design recommendations for through hole reflow technology can be found under "Downloads"	1939316	MC 0,5/12-G-2,5 THT	Buy on EAN