



Automatización Eléctrica
Especialistas en Automatización

At the end of this document you will find links to products related to this catalog. You can go directly to our shop by clicking [HERE](#). [HERE](#)

Printed-circuit board connector - FKIC 2,5/13-ST-5,08-RN - 1925977

Please be informed that the data shown in this PDF Document is generated from our Online Catalog. Please find the complete data in the user's documentation. Our General Terms of Use for Downloads are valid (<http://phoenixcontact.com/download>)

Plug component, Nominal current: 12 A, Rated voltage (III/2): 320 V, Number of positions: 13, Pitch: 5.08 mm, Connection method: Push-in spring connection, Color: green, Contact surface: Tin, Article with engagement nose



The figure shows a 10-position version of the product

Why buy this product

- Can be combined with inverted base strips and plugs for shock-proof applications
- Plug with inverted contact system (pin contact)
- SK 5/3,8 or SK 5,08/3,8 marker cards



Key Commercial Data

Packing unit	50 STK
GTIN	4 017918 820039

Technical data

Dimensions

Pitch	5.08 mm
Dimension a	60.96 mm

General

Range of articles	FKIC 2,5/...-ST-RN
Insulating material group	I
Rated surge voltage (III/3)	4 kV
Rated surge voltage (III/2)	4 kV
Rated surge voltage (II/2)	4 kV
Rated voltage (III/3)	320 V
Rated voltage (III/2)	320 V
Rated voltage (II/2)	630 V
Connection in acc. with standard	EN-VDE

Printed-circuit board connector - FKIC 2,5/13-ST-5,08-RN - 1925977

Technical data

General

Nominal current I_N	12 A
Nominal cross section	2.5 mm ²
Maximum load current	12 A
Insulating material	PA
Flammability rating according to UL 94	V0
Internal cylindrical gage	A2
Stripping length	10 mm
Number of positions	13

Connection data

Conductor cross section solid min.	0.2 mm ²
Conductor cross section solid max.	2.5 mm ²
Conductor cross section flexible min.	0.2 mm ²
Conductor cross section flexible max.	2.5 mm ²
Conductor cross section flexible, with ferrule without plastic sleeve min.	0.25 mm ²
Conductor cross section flexible, with ferrule without plastic sleeve max.	2.5 mm ²
Conductor cross section flexible, with ferrule with plastic sleeve min.	0.25 mm ²
Conductor cross section flexible, with ferrule with plastic sleeve max.	2.5 mm ²
Conductor cross section AWG min.	24
Conductor cross section AWG max.	12
2 conductors with same cross section, stranded, TWIN ferrules with plastic sleeve, min.	0.5 mm ²
2 conductors with same cross section, stranded, TWIN ferrules with plastic sleeve, max.	1 mm ²
Minimum AWG according to UL/CUL	26
Maximum AWG according to UL/CUL	12

Standards and Regulations

Connection in acc. with standard	EN-VDE
	CUL
Flammability rating according to UL 94	V0

Classifications

eCl@ss

eCl@ss 4.0	272607xx
eCl@ss 4.1	27260701
eCl@ss 5.0	27260701
eCl@ss 5.1	27260701
eCl@ss 6.0	27260704
eCl@ss 7.0	27440402
eCl@ss 8.0	27440309

Printed-circuit board connector - FKIC 2,5/13-ST-5,08-RN - 1925977

Classifications

ETIM

ETIM 3.0	EC001121
ETIM 4.0	EC002638
ETIM 5.0	EC002638

UNSPSC

UNSPSC 6.01	30211810
UNSPSC 7.0901	39121409
UNSPSC 11	39121409
UNSPSC 12.01	39121409
UNSPSC 13.2	39121409

Approvals

Approvals

Approvals

UL Recognized / VDE Gutachten mit Fertigungsüberwachung / cUL Recognized / IECCEB CB Scheme / EAC / cULus Recognized

Ex Approvals

Approvals submitted

Approval details

UL Recognized 		
	B	D
mm ² /AWG/kcmil	26-12	26-12
Nominal current I _N	10 A	10 A
Nominal voltage U _N	300 V	300 V

VDE Gutachten mit Fertigungsüberwachung 	
mm ² /AWG/kcmil	0.2-2.5
Nominal current I _N	12 A
Nominal voltage U _N	250 V

Printed-circuit board connector - FKIC 2,5/13-ST-5,08-RN - 1925977

Approvals

cUL Recognized		
	B	D
mm ² /AWG/kcmil	26-12	26-12
Nominal current I _N	10 A	10 A
Nominal voltage U _N	300 V	300 V

IECEE CB Scheme	
mm ² /AWG/kcmil	0.2-2.5
Nominal current I _N	12 A
Nominal voltage U _N	250 V

EAC

cULus Recognized

Drawings

Dimensional drawing

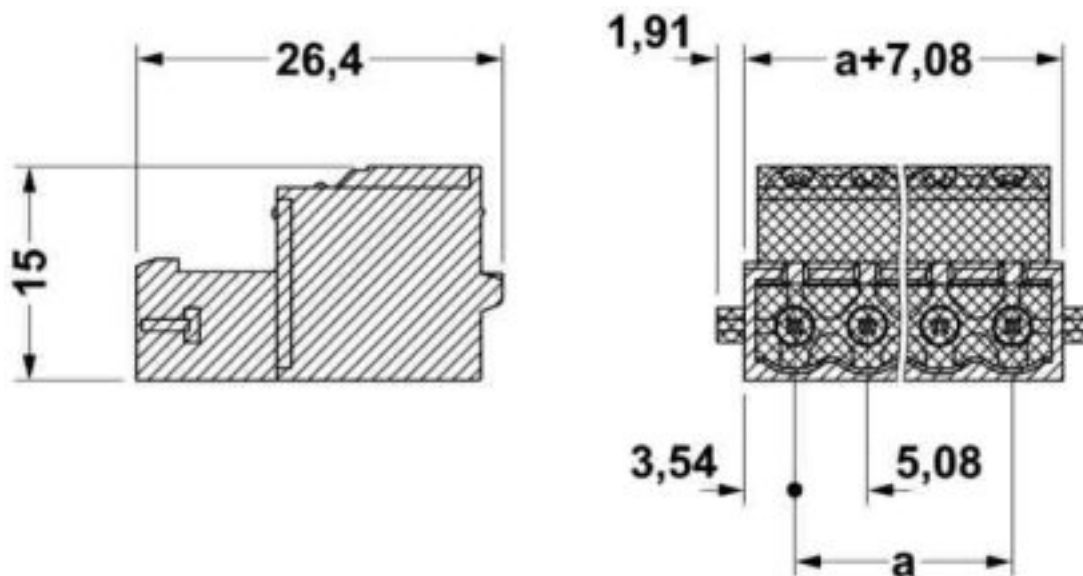

Phoenix Contact 2016 © - all rights reserved
<http://www.phoenixcontact.com>

PHOENIX CONTACT GmbH & Co. KG
Flachmarktstr. 8
32825 Blomberg
Germany
Tel. +49 5235 300
Fax +49 5235 3 41200
<http://www.phoenixcontact.com>



Below is a list of articles with direct links to our shop Electric Automation Network where you can see:

- Quote per purchase volume in real time.
- Online documentation and datasheets of all products.
- Estimated delivery time enquiry in real time.
- Logistics systems for the shipment of materials almost anywhere in the world.
- Purchasing management, order record and tracking of shipments.

To access the product, [click on the green button.](#)

Product	Code	Reference	Product link
Plug component, Nominal current: 12 A, Rated voltage (III/2): 320 V, Number of positions: 13, Pitch: 5.08 mm, Connection method: Push-in spring connection, Color: green, Contact surface: Tin, Article with engagement nose	1925977	FKIC 2,5/13-ST-5,08-RN	Buy on EAN