



Automatización Eléctrica
Especialistas en Automatización

At the end of this document you will find links to products related to this catalog. You can go directly to our shop by clicking [HERE](#). [HERE](#)

Printed-circuit board connector - FRONT-MC 1,5/16-STF-3,81 - 1850990

Please be informed that the data shown in this PDF Document is generated from our Online Catalog. Please find the complete data in the user's documentation. Our General Terms of Use for Downloads are valid (<http://phoenixcontact.com/download>)

Plug component, Nominal current: 8 A, Rated voltage (III/2): 160 V, Number of positions: 16, Pitch: 3.81 mm, Connection method: Front screw connection, Color: green, Contact surface: Tin



The figure shows a 10-position version of the product

Why buy this product

- Generously dimensioned wiring space
- Screwdriver axis parallel to the conductor axis
- Pitch: 3.81 mm
- Plug with front screw connection
- Individual position coding by removing the coding tab and connecting the coding profile to the header

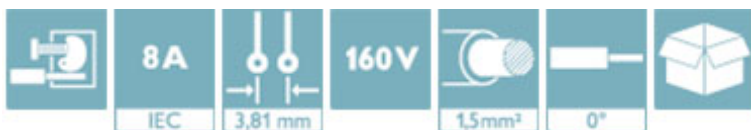

Key Commercial Data

Packing unit	50 STK
GTIN	4 017918 110000

Technical data

Dimensions

Width	71.35 mm
Pitch	3.81 mm
Dimension a	57.15 mm

General

Range of articles	FRONT-MC 1,5/...-STF
Insulating material group	I
Rated surge voltage (III/3)	2.5 kV
Rated surge voltage (III/2)	2.5 kV
Rated surge voltage (II/2)	2.5 kV
Rated voltage (III/3)	160 V

Printed-circuit board connector - FRONT-MC 1,5/16-STF-3,81 - 1850990

Technical data

General

Rated voltage (III/2)	160 V
Rated voltage (II/2)	320 V
Connection in acc. with standard	EN-VDE
Nominal current I _N	8 A
Nominal cross section	1.5 mm ²
Maximum load current	8 A (with 1.5 mm ² conductor cross section)
Insulating material	PA
Flammability rating according to UL 94	V0
Internal cylindrical gage	A1
Stripping length	9 mm
Number of positions	16
Screw thread	M2
Tightening torque, min	0.22 Nm
Tightening torque max	0.25 Nm

Connection data

Conductor cross section solid min.	0.14 mm ²
Conductor cross section solid max.	1.5 mm ²
Conductor cross section flexible min.	0.14 mm ²
Conductor cross section flexible max.	1.5 mm ²
Conductor cross section flexible, with ferrule without plastic sleeve min.	0.25 mm ²
Conductor cross section flexible, with ferrule without plastic sleeve max.	1.5 mm ²
Conductor cross section flexible, with ferrule with plastic sleeve min.	0.25 mm ²
Conductor cross section flexible, with ferrule with plastic sleeve max.	0.5 mm ²
Conductor cross section AWG min.	28
Conductor cross section AWG max.	16
2 conductors with same cross section, solid min.	0.14 mm ²
2 conductors with same cross section, solid max.	0.5 mm ²
2 conductors with same cross section, stranded min.	0.14 mm ²
2 conductors with same cross section, stranded max.	0.75 mm ²
2 conductors with same cross section, stranded, ferrules without plastic sleeve, min.	0.25 mm ²
2 conductors with same cross section, stranded, ferrules without plastic sleeve, max.	0.34 mm ²
2 conductors with same cross section, stranded, TWIN ferrules with plastic sleeve, min.	0.5 mm ²
2 conductors with same cross section, stranded, TWIN ferrules with plastic sleeve, max.	0.5 mm ²
Minimum AWG according to UL/CUL	30
Maximum AWG according to UL/CUL	16

Standards and Regulations

Connection in acc. with standard	EN-VDE
----------------------------------	--------

Printed-circuit board connector - FRONT-MC 1,5/16-STF-3,81 - 1850990

Technical data

Standards and Regulations

	CSA
Flammability rating according to UL 94	V0

Classifications

eCl@ss

eCl@ss 4.0	272607xx
eCl@ss 4.1	27260701
eCl@ss 5.0	27260701
eCl@ss 5.1	27260701
eCl@ss 6.0	27260704
eCl@ss 7.0	27440402
eCl@ss 8.0	27440309

ETIM

ETIM 3.0	EC001121
ETIM 4.0	EC002638
ETIM 5.0	EC002638

UNSPSC

UNSPSC 6.01	30211810
UNSPSC 7.0901	39121409
UNSPSC 11	39121409
UNSPSC 12.01	39121409
UNSPSC 13.2	39121409

Approvals

Approvals

Approvals

CSA / VDE Gutachten mit Fertigungsüberwachung / cUL Recognized / IECCE CB Scheme / CCA / EAC / cULus Recognized

Ex Approvals

Approvals submitted

Approval details

Printed-circuit board connector - FRONT-MC 1,5/16-STF-3,81 - 1850990

Approvals

CSA 		
	B	D
mm ² /AWG/kcmil	28-16	28-16
Nominal current IN	8 A	8 A
Nominal voltage UN	300 V	300 V

VDE Gutachten mit Fertigungsüberwachung 	
mm ² /AWG/kcmil	0.2-1.5
Nominal current IN	8 A
Nominal voltage UN	160 V

cUL Recognized 		
	B	D
mm ² /AWG/kcmil	30-16	30-16
Nominal current IN	8 A	8 A
Nominal voltage UN	300 V	300 V

IECEE CB Scheme 	
mm ² /AWG/kcmil	0.2-1.5
Nominal current IN	8 A
Nominal voltage UN	160 V

CCA	
mm ² /AWG/kcmil	0.2-1.5
Nominal current IN	8 A
Nominal voltage UN	160 V

EAC	
-----	--

Printed-circuit board connector - FRONT-MC 1,5/16-STF-3,81 - 1850990

Approvals

cULus Recognized		
	B	D
mm ² /AWG/kcmil	30-16	30-16
Nominal current I _N	8 A	8 A
Nominal voltage U _N	300 V	300 V

Drawings

Diagram

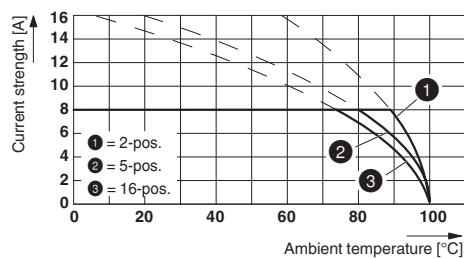

Type: FRONT-MC 1,5/...-STF-3,81 with SMC 1,5/...-GF-3,81

Dimensional drawing

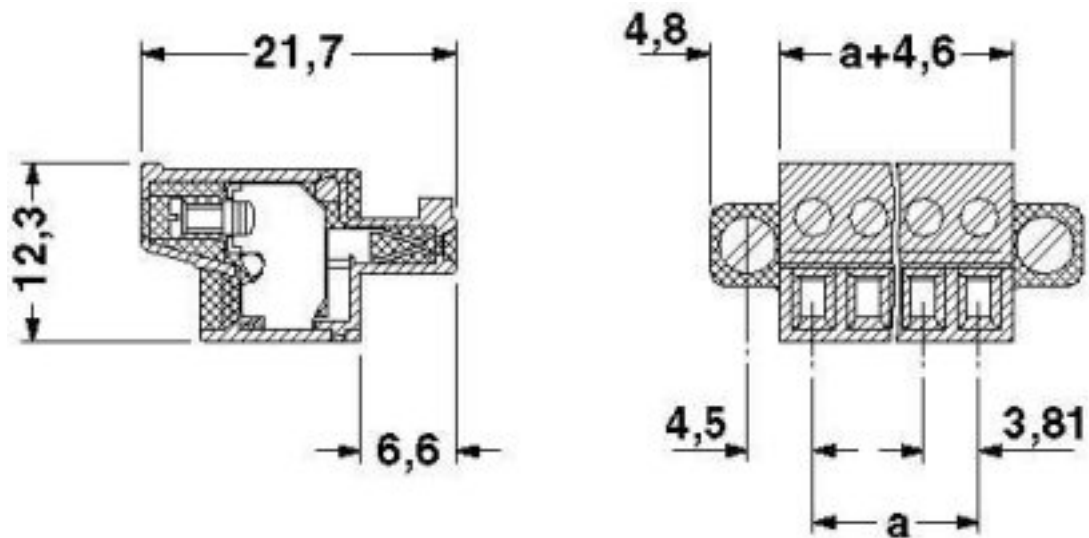

Phoenix Contact 2016 © - all rights reserved
<http://www.phoenixcontact.com>

PHOENIX CONTACT GmbH & Co. KG
Flachmarktstr. 8
32825 Blomberg
Germany
Tel. +49 5235 300
Fax +49 5235 3 41200
<http://www.phoenixcontact.com>



Below is a list of articles with direct links to our shop Electric Automation Network where you can see:

- Quote per purchase volume in real time.
- Online documentation and datasheets of all products.
- Estimated delivery time enquiry in real time.
- Logistics systems for the shipment of materials almost anywhere in the world.
- Purchasing management, order record and tracking of shipments.

To access the product, [click on the green button.](#)

Product	Code	Reference	Product link
Plug component, Nominal current: 8 A, Rated voltage (III/2): 160 V, Number of positions: 16, Pitch: 3.81 mm, Connection method: Screw connection, Color: green, Contact surface: Tin	1850990	FRONT-MC 1,5/16- STF-3,81	Buy on EAN