



Automatización Eléctrica
Especialistas en Automatización

At the end of this document you will find links to products related to this catalog. You can go directly to our shop by clicking [HERE](#). [HERE](#)

Base strip - MDSTBW 2,5/ 8-G - 1846878

Please be informed that the data shown in this PDF Document is generated from our Online Catalog. Please find the complete data in the user's documentation. Our General Terms of Use for Downloads are valid (<http://phoenixcontact.com/download>)

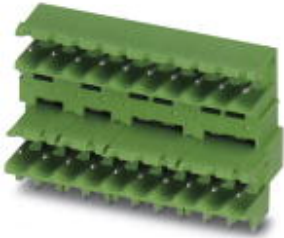

Header, Nominal current: 10 A, Rated voltage (III/2): 320 V, Number of positions: 8, Pitch: 5 mm, Color: green, Contact surface: Tin, Mounting: Wave soldering, The article can be aligned to create different nos. of positions! In combination with MVSTB or FKCV plug components, both an MVSTBW (or FKCVW) and an MVSTBR plug (or FKCVR) must be used. Combination with TMSTBP plug components is not possible!

The figure shows a 10-position version of the product

Why buy this product

- MDSTBW 2,5/...-G with stand-off
- G1 types without offset levels, for flush installation on the front of devices
- Add-on ejectors for high-pos. connectors should be mounted to the left and right

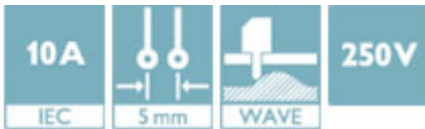

Key Commercial Data

Packing unit	50 STK
GTIN	 4 017918 183844

Technical data

Dimensions

Length	22.1 mm
Pitch	5.00 mm
Dimension a	35 mm
Constructional height	23.7 mm
Length of the solder pin	3.8 mm
Pin dimensions	1 x 1 mm
Hole diameter	1.4 mm

General

Range of articles	MDSTBW 2,5/...-G
Insulating material group	IIIa
Rated surge voltage (III/3)	4 kV
Rated surge voltage (III/2)	4 kV

Base strip - MDSTBW 2,5/ 8-G - 1846878

Technical data

General

Rated surge voltage (II/2)	4 kV
Rated voltage (III/3)	250 V
Rated voltage (III/2)	320 V
Rated voltage (II/2)	400 V
Connection in acc. with standard	EN-VDE
Nominal current I _N	10 A
Maximum load current	10 A
Insulating material	PBT
Flammability rating according to UL 94	V0
Color	green
Number of positions	8

Standards and Regulations

Connection in acc. with standard	EN-VDE
	CSA
Flammability rating according to UL 94	V0

Classifications

eCl@ss

eCl@ss 4.0	272607xx
eCl@ss 4.1	27260701
eCl@ss 5.0	27260701
eCl@ss 5.1	27260701
eCl@ss 6.0	27260704
eCl@ss 7.0	27440402
eCl@ss 8.0	27440402
eCl@ss 9.0	27440402

ETIM

ETIM 3.0	EC001121
ETIM 4.0	EC002637
ETIM 5.0	EC002637

UNSPSC

UNSPSC 6.01	30211810
UNSPSC 7.0901	39121409
UNSPSC 11	39121409
UNSPSC 12.01	39121409
UNSPSC 13.2	39121409

Base strip - MDSTBW 2,5/ 8-G - 1846878

Approvals

Approvals

Approvals

CSA / VDE Gutachten mit Fertigungsüberwachung / IECCEB Scheme / cULus Recognized

Ex Approvals

Approvals submitted

Approval details

CSA 		
	B	D
Nominal current I _N	15 A	15 A
Nominal voltage U _N	300 V	300 V

VDE Gutachten mit Fertigungsüberwachung 	
Nominal current I _N	10 A
Nominal voltage U _N	250 V

IECCEB Scheme 	
Nominal current I _N	10 A
Nominal voltage U _N	250 V

cULus Recognized		
	B	D
Nominal current I _N	15 A	10 A
Nominal voltage U _N	300 V	300 V

Drawings

Base strip - MDSTBW 2,5/ 8-G - 1846878

Dimensional drawing

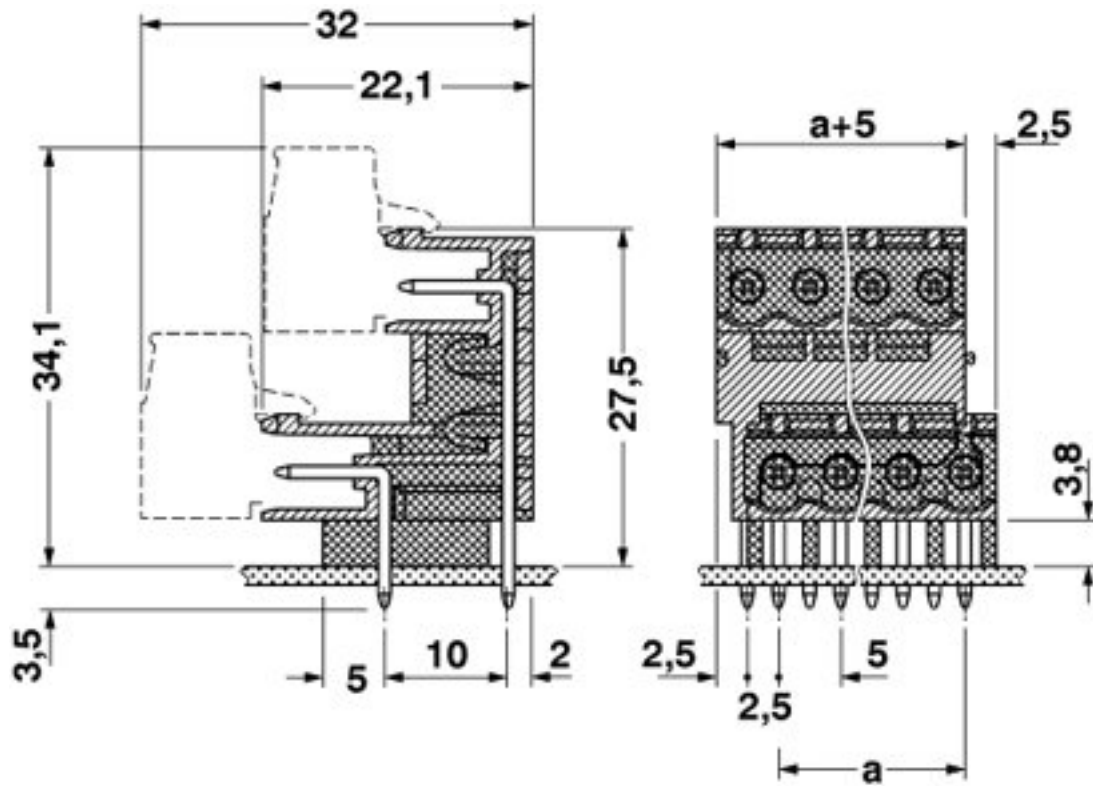

Phoenix Contact 2016 © - all rights reserved
<http://www.phoenixcontact.com>

PHOENIX CONTACT GmbH & Co. KG
Flachsmarktstr. 8
32825 Blomberg
Germany
Tel. +49 5235 300
Fax +49 5235 3 41200
<http://www.phoenixcontact.com>



Below is a list of articles with direct links to our shop Electric Automation Network where you can see:

- Quote per purchase volume in real time.
- Online documentation and datasheets of all products.
- Estimated delivery time enquiry in real time.
- Logistics systems for the shipment of materials almost anywhere in the world.
- Purchasing management, order record and tracking of shipments.

To access the product, [click on the green button.](#)

Product	Code	Reference	Product link
Header, Nominal current: 10 A, Rated voltage (III/2): 320 V, Number of positions: 8, Pitch: 5 mm, Color: green, Contact surface: Tin, Mounting: Soldering, The article can be aligned to create different nos. of positions! In combination with MVSTB or FKCV plug components, both an MVSTBW (or FKCVW) and an MVSTBR plug (or FKCVR) must be used. Combination with TMSTBP plug components is not possible!	1846878	MDSTBW 2,5/ 8-G	Buy on EAN