



**Automatización Eléctrica**  
Especialistas en Automatización

At the end of this document you will find links to products related to this catalog. You can go directly to our shop by clicking [HERE](#). [HERE](#)

# Printed-circuit board connector - DMC 1,5/ 7-G1F-3,5-LRP20THRR56 - 1818559

Please be informed that the data shown in this PDF Document is generated from our Online Catalog. Please find the complete data in the user's documentation. Our General Terms of Use for Downloads are valid (<http://phoenixcontact.com/download>)



Header, Nominal current: 8 A, Rated voltage (III/2): 160 V, Number of positions: 7, Pitch: 3.5 mm, Color: black, Contact surface: Tin, Mounting: THR soldering

The figure shows a 10-pos. version with 20 contacts

## Key Commercial Data

Packing unit	180 STK
Minimum order quantity	180 STK
GTIN	 4 046356 757669

## Technical data

### Dimensions

Length	11.6 mm
Pitch	3.50 mm
Dimension a	21 mm
Constructional height	10.8 mm
Height	12.8 mm
Length of the solder pin	2 mm
Pin dimensions	0,8 x 0,8 mm
Pin spacing	2.50 mm
Hole diameter	1.4 mm

### General

Range of articles	DMC 1,5/...G1F-THR
Insulating material group	IIIa
Rated surge voltage (III/3)	2.5 kV
Rated surge voltage (III/2)	2.5 kV
Rated surge voltage (II/2)	2.5 kV
Rated voltage (III/3)	160 V
Rated voltage (III/2)	160 V
Rated voltage (II/2)	250 V

# Printed-circuit board connector - DMC 1,5/ 7-G1F-3,5-LRP20THRR56 - 1818559

## Technical data

### General

Connection in acc. with standard	EN-VDE
Nominal current I <sub>N</sub>	8 A
Maximum load current	8 A
Insulating material	LCP
Flammability rating according to UL 94	V0
Color	black
Number of positions	7

### Standards and Regulations

Connection in acc. with standard	EN-VDE
	CUL
Flammability rating according to UL 94	V0

## Classifications

### eCl@ss

eCl@ss 4.0	272607xx
eCl@ss 4.1	27260701
eCl@ss 5.0	27260701
eCl@ss 5.1	27260701
eCl@ss 6.0	27260704
eCl@ss 7.0	27440402
eCl@ss 8.0	27440402
eCl@ss 9.0	27440402

### ETIM

ETIM 3.0	EC001121
ETIM 4.0	EC002637
ETIM 5.0	EC002637

### UNSPSC

UNSPSC 6.01	30211810
UNSPSC 7.0901	39121409
UNSPSC 11	39121409
UNSPSC 12.01	39121409
UNSPSC 13.2	39121409

## Approvals

### Approvals

# Printed-circuit board connector - DMC 1,5/ 7-G1F-3,5-LRP20THRR56 - 1818559

## Approvals

### Approvals

VDE Gutachten mit Fertigungsüberwachung / IEC60335 CB Scheme / cULus Recognized

### Ex Approvals

### Approvals submitted

## Approval details

VDE Gutachten mit Fertigungsüberwachung 	
Nominal current I <sub>N</sub>	8 A
Nominal voltage U <sub>N</sub>	160 V

IECEE CB Scheme 	
Nominal current I <sub>N</sub>	8 A
Nominal voltage U <sub>N</sub>	160 V

cULus Recognized		
	B	C
Nominal current I <sub>N</sub>	8 A	8 A
Nominal voltage U <sub>N</sub>	150 V	50 V

## Drawings

# Printed-circuit board connector - DMC 1,5/ 7-G1F-3,5-LRP20THRR56 - 1818559

Schematic diagram

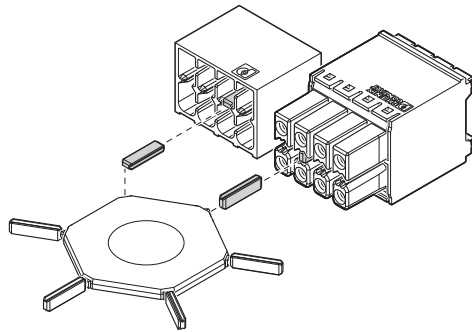

Drilling diagram

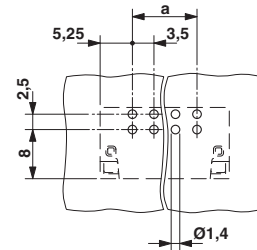

Use of the CP-DMC... coding profile

Diagram

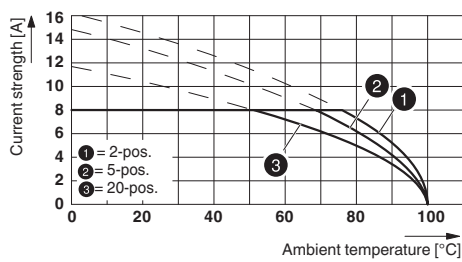

Dimensional drawing

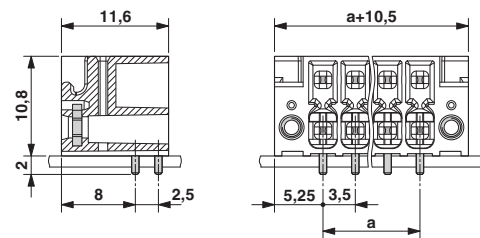

Schematic diagram

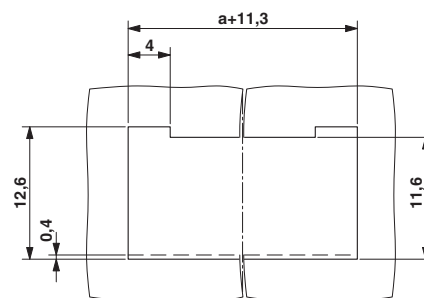

Panel cutout

Below is a list of articles with direct links to our shop Electric Automation Network where you can see:

- Quote per purchase volume in real time.
- Online documentation and datasheets of all products.
- Estimated delivery time enquiry in real time.
- Logistics systems for the shipment of materials almost anywhere in the world.
- Purchasing management, order record and tracking of shipments.

To access the product, [click on the green button.](#)

<b>Product</b>	<b>Code</b>	<b>Reference</b>	<b>Product link</b>
Header, Nominal current: 8 A, Rated voltage (III/2): 160 V, Number of positions: 7, Pitch: 3.5 mm, Color: black, Contact surface: Tin, Mounting: Taped SMD/THT/THR components	1818559	DMC 1,5/ 7- G1F-3,5- LRP20THRR56	<a href="#">Buy on EAN</a>