



Automatización Eléctrica
Especialistas en Automatización

At the end of this document you will find links to products related to this catalog. You can go directly to our shop by clicking [HERE](#). [HERE](#)

Sensor/actuator box - SACB-6/12-L- 5,0HPUR SCO - 1517288

Please be informed that the data shown in this PDF Document is generated from our Online Catalog. Please find the complete data in the user's documentation. Our General Terms of Use for Downloads are valid (<http://phoenixcontact.com/download>)



Sensor/actuator box, Application: Standard, Connection method: M12-SPEEDCON-socket Metal, Number of slots: 6, Number of positions: 5, Coding: A - standard, Slot assignment: Double, Status indication: Yes, pnp; Master cable connection: Fixed connection 180°, PUR halogen free, Cable length: 5 m, Shielding: No

Why buy this product

- Safety in the field, thanks to molded housing and high degree of protection
- Flexible, distributed bundling of signals in one master cable
- Convenient: increased machine availability thanks to quick and easy diagnostics
- Save space: distributor box with double occupancy for two sensors in one slot
- Save time, thanks to installation with SPEEDCON fast locking system



Key Commercial Data

Packing unit	1 STK
GTIN	 4 017918 967956

Technical data

General

Rated voltage	24 V DC
Max. operating voltage U_{max}	30 V DC
Current carrying capacity per I/O signal	2 A
Current carrying capacity per slot	4 A
Total rated current	12 A
Number of positions	5
Number of slots	6
Flammability rating according to UL 94	V0
Sensor/actuator connection system	M12-SPEEDCON-socket

Ambient conditions

Degree of protection	IP65
	IP67

Sensor/actuator box - SACB-6/12-L- 5,0HPUR SCO - 1517288

Technical data

Ambient conditions

	IP69K
Ambient temperature (operation)	-30 °C ... 90 °C
	-40 °C ... 90 °C (for fixed installation)
	-5 °C ... 80 °C (for flexible installation)

Local diagnostics function

Local diagnostics	Supply voltage Green LED
	Status display I/O Yellow LED

Master cable connection data

Connection method	Fixed connection
Length of cable	5 m
Tightening torque slot sensor/actuator cable	0.4 Nm
Tightening torque of mounting screw for fixing the housing	0.5 Nm

Insulation material

Housing material	PBT
Material of the moulding mass	PUR
Contact material	Cu alloy
Contact surface material	Gold-plated
Contact carrier material	PA
Material of threaded sleeve	Zinc die-cast
Material of threaded sleeve surface	Nickel-plated
O-ring material	NBR

Pin assignment

Slot/position = Wire color or connection	1 / 4 (A) = WH
	1 / 2 (B) = GY/PK
	2 / 4 (A) = GN
	2 / 2 (B) = RD/BU
	3 / 4 (A) = YE
	3 / 2 (B) = WH/GN
	4 / 4 (A) = GY
	4 / 2 (B) = BN/GN
	5 / 4 (A) = PK
	5 / 2 (B) = WH/YE
	6 / 4 (A) = RD
	6 / 2 (B) = YE/BN
	1-6 / 1 (+ 24 V) = BN
	1-6 / 3 (0 V) = BU
	1-6 / 5 (PE) = GN/YE

Standards and Regulations

Sensor/actuator box - SACB-6/12-L- 5,0HPUR SCO - 1517288

Technical data

Standards and Regulations

Standard designation	M12 connector
Standards/regulations	IEC 61076-2-101
Connection in acc. with standard	CUL
Flammability rating according to UL 94	V0

Cable

Cable abbreviation	Li9Y11Y-HF
Conductor cross section	12x 0.5 mm ² (Signal)
	3x 0.5 mm ² (Power)
AWG signal line	20
AWG power supply	17
Conductor structure signal line	64x 0.10 mm
Conductor structure, voltage supply	128x 0.10 mm
Overall twist	Wires twisted in layers
External sheath, color	black RAL 9005
External cable diameter D	10.4 mm ±0,3 mm
Number of bending cycles	2000000
Minimum bending radius, drag chain applications	10 x D
Traversing path	2 m
Traversing rate	2 m/s
Outer sheath, material	PUR
Conductor material	Bare Cu litz wires
Nominal voltage, cable	300 V
Test voltage, cable	2000 V
Ambient temperature (operation)	-40 °C ... 90 °C (cable, fixed installation)
	-5 °C ... 80 °C (cable, flexible installation)

Classifications

eCl@ss

eCl@ss 4.0	27140815
eCl@ss 4.1	27140815
eCl@ss 5.0	27143423
eCl@ss 5.1	27143423
eCl@ss 6.0	27143423
eCl@ss 7.0	27449001
eCl@ss 8.0	27279219

ETIM

ETIM 2.0	EC000200
ETIM 3.0	EC001856

Sensor/actuator box - SACB-6/12-L- 5,0HPUR SCO - 1517288

Classifications

ETIM

ETIM 4.0	EC002585
ETIM 5.0	EC002585

UNSPSC

UNSPSC 6.01	31261501
UNSPSC 7.0901	31261501
UNSPSC 11	31261501
UNSPSC 12.01	31261501
UNSPSC 13.2	31261501

Approvals

Approvals

Approvals

EAC / cULus Recognized

Ex Approvals

Approvals submitted

Approval details

EAC

cULus Recognized 

Drawings

Schematic diagram

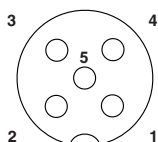

M12 slot, socket, 5-pos.

Cable cross section

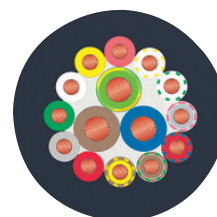

Sensor/actuator box - SACB-6/12-L- 5,0HPUR SCO - 1517288

Circuit diagram

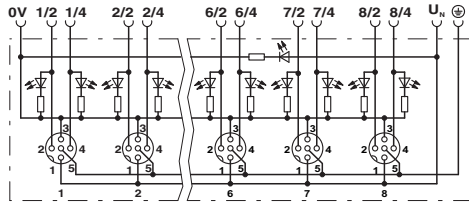

Dimensional drawing

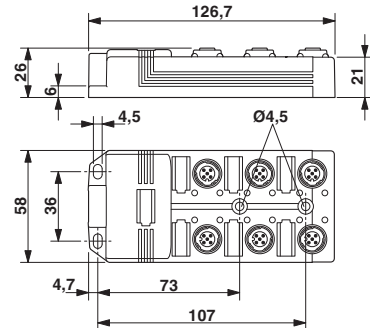

Phoenix Contact 2016 © - all rights reserved
<http://www.phoenixcontact.com>

PHOENIX CONTACT GmbH & Co. KG
Flachsmarktstr. 8
32825 Blomberg
Germany
Tel. +49 5235 300
Fax +49 5235 3 41200
<http://www.phoenixcontact.com>

Below is a list of articles with direct links to our shop Electric Automation Network where you can see:

- Quote per purchase volume in real time.
- Online documentation and datasheets of all products.
- Estimated delivery time enquiry in real time.
- Logistics systems for the shipment of materials almost anywhere in the world.
- Purchasing management, order record and tracking of shipments.

To access the product, [click on the green button.](#)

Product	Code	Reference	Product link
Sensor/actuator box, Application: Standard, Connection method: M12-SPEEDCON-socket Metal, Number of slots: 6, Number of positions: 5, Coding: A - standard, Slot assignment: Double, Status indication: Yes, pnp; Master cable connection: Fixed connection 180°, PUR halogen free, Cable length: 5 m, Shielding: No	1517288	SACB-6/12-L-5,0HPUR SCO	Buy on EAN