



Automatización Eléctrica
Especialistas en Automatización

At the end of this document you will find links to products related to this catalog. You can go directly to our shop by clicking [HERE](#). [HERE](#)

Double valve connector cable - SAC- 5,0/0,2-116/2XBI-1L-Z - 1458444

Please be informed that the data shown in this PDF Document is generated from our Online Catalog. Please find the complete data in the user's documentation. Our General Terms of Use for Downloads are valid (<http://phoenixcontact.com/download>)



Double valve connector cable, 4-position, PUR/PVC, black RAL 9005, free cable end, on Valve connector BI (11 mm), with 1 LED, connected with Z diode and Valve connector BI (11 mm), with 1 LED, connected with Z diode, Cable length: 5 m, Valve connector distance: 0.2 m

Why buy this product

- Easy and safe: 100% electrically tested plug-in components
- Robust valve connector with Zener diode as protective circuit
- Efficient: control valves with two connections via a single connecting cable
- Convenient: increased machine availability thanks to quick and easy diagnostics

Key Commercial Data

Packing unit	1 STK
GTIN	 4 046356 638890

Technical data

Dimensions

Length of cable	5 m
Valve connector distance	0.2 m

Ambient conditions

Ambient temperature (operation)	-25 °C ... 85 °C (valve plug)
Degree of protection	IP65
	IP67

General

Rated current at 40°C	4 A
Rated voltage	24 V AC/DC
Number of positions	4
Insulation resistance	≥ 100 MΩ
Status display	1 LED
Protective circuit/component	Z diode
Overvoltage category	II
Degree of pollution	3
Insertion/withdrawal cycles	50

Double valve connector cable - SAC- 5,0/0,2-116/2XBI-1L-Z - 1458444

Technical data

General

Torque	0.6 Nm (Valve connector)
--------	--------------------------

Material

Flammability rating according to UL 94	HB
Valve plug contact material	CuSn
Valve plug contact surface material	Sn
Valve plug contact insert material	PA 66
Material housing valve plug	TPU
Sealing material	TPU (Seal molded)

Standards and Regulations

Flammability rating according to UL 94	HB
--	----

Cable

Cable type	PUR/PVC, 0.75 mm ² , black
Cable type (abbreviation)	116
Cable abbreviation	LiYY11Y-HF
UL AWM style	20549
Conductor cross section	4x 0.75 mm ²
AWG signal line	18
Conductor structure signal line	24x 0.20 mm
Core diameter including insulation	1.7 mm ±0.05 mm
Wire colors	Black 1, black 2, black 3, green/yellow
Overall twist	4 wires, twisted
External sheath, color	black
External cable diameter D	6.3 mm ±0.2 mm
Smallest bending radius, fixed installation	63 mm
Outer sheath, material	PUR
Material, inner sheath	PVC
Material conductor insulation	PVC
Conductor material	Bare Cu litz wires
Insulation resistance	≥ 20 MΩ*km
Conductor resistance	26 Ω/km (at 20 °C)
Nominal voltage, cable	300 V
Test voltage, cable	1200 V
Flame resistance	According to DIN VDE 0482
	According to DIN EN 50265-2-1
	in acc. with UL FT-2
Ambient temperature (operation)	-40 °C ... 80 °C (cable, fixed installation)
	-5 °C ... 80 °C (cable, flexible installation)

Double valve connector cable - SAC- 5,0/0,2-116/2XBI-1L-Z - 1458444

Classifications

eCl@ss

eCl@ss 4.0	27060306
eCl@ss 4.1	27060306
eCl@ss 5.0	27061801
eCl@ss 5.1	27061801
eCl@ss 6.0	27061801
eCl@ss 7.0	27061801
eCl@ss 8.0	27279218

ETIM

ETIM 4.0	EC001855
ETIM 5.0	EC001855

UNSPSC

UNSPSC 6.01	31251501
UNSPSC 7.0901	31251501
UNSPSC 11	31251501
UNSPSC 12.01	31251501
UNSPSC 13.2	31251501

Drawings

Schematic diagram

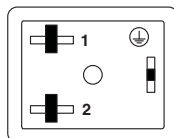

Valve connector pin assignment, type BI

Cable cross section

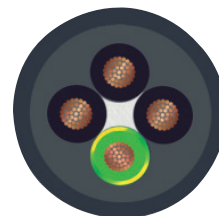

PUR/PVC black [116]

Double valve connector cable - SAC- 5,0/0,2-116/2XBI-1L-Z - 1458444

Dimensional drawing

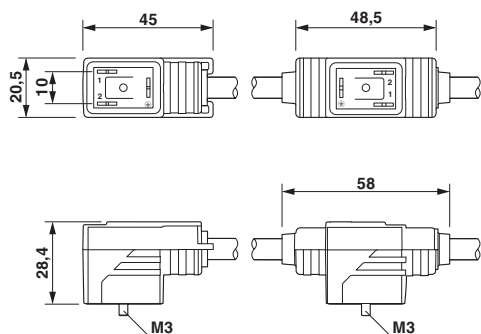

Dimensional drawing

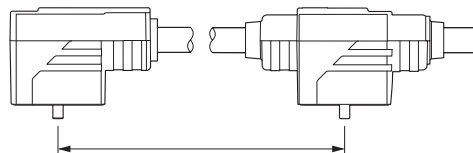

Valve connector spacing

Double valve plug, 2 x type BI

Circuit diagram

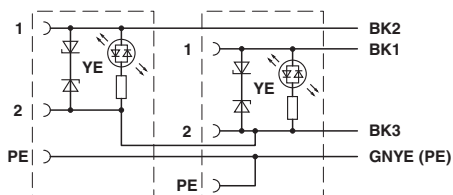

Contact assignment of the double-valve connector

Phoenix Contact 2016 © - all rights reserved
<http://www.phoenixcontact.com>

PHOENIX CONTACT GmbH & Co. KG
 Flachsmarktstr. 8
 32825 Blomberg
 Germany
 Tel. +49 5235 300
 Fax +49 5235 3 41200
<http://www.phoenixcontact.com>

Below is a list of articles with direct links to our shop Electric Automation Network where you can see:

- Quote per purchase volume in real time.
- Online documentation and datasheets of all products.
- Estimated delivery time enquiry in real time.
- Logistics systems for the shipment of materials almost anywhere in the world.
- Purchasing management, order record and tracking of shipments.

To access the product, [click on the green button.](#)

Product	Code	Reference	Product link
Double valve connector cable, 4-position, PUR/PVC, black RAL 9005, free cable end, on Valve connector BI (11 mm), with 1 LED, connected with Z diode and Valve connector BI (11 mm), with 1 LED, connected with Z diode, Cable length: 5 m, Valve connector distance: 0.2 m	1458444	SAC-5,0/0,2-116/2XBI-1L-Z	Buy on EAN