



Automatización Eléctrica
Especialistas en Automatización

At the end of this document you will find links to products related to this catalog. You can go directly to our shop by clicking [HERE](#). [HERE](#)

Power cable - SAC-5P- 3,0-440/MINFR PWR - 1443763

Please be informed that the data shown in this PDF Document is generated from our Online Catalog. Please find the complete data in the user's documentation. Our General Terms of Use for Downloads are valid (<http://phoenixcontact.com/download>)



Power cable, 5-position, PUR, gray RAL 7001, free cable end, on Socket angled 7/8"-16UNF, Cable length: 3 m, 1.5 mm² conductor cross section, For power supply

Why buy this product

- Easy and safe: 100% electrically tested plug-in components
- Robust connectors in size 7/8"-16UNF
- High-performance: connectors and cables with a large conductor cross section for power supply

Key Commercial Data

Packing unit	1 STK
GTIN	 4 046356 537339

Technical data

Dimensions

Length of cable	3 m
-----------------	-----

Ambient conditions

Ambient temperature (operation)	-40 °C ... 90 °C (Socket)
Degree of protection	IP65
	IP67
	IP68

General

Rated current at 40°C	10 A
Rated voltage	600 V
Rated surge voltage	4000 V
Number of positions	5
Insulation resistance	≥ 10 MΩ
Coding	A - standard
Status display	No
Protective circuit/component	Unwired
Overvoltage category	II
Degree of pollution	3

Power cable - SAC-5P- 3,0-440/MINFR PWR - 1443763

Technical data

General

Structure of individual litz in acc. with VDE 0295 / smallest wire diameter	VDE 0295 class 5
Insertion/withdrawal cycles	100

Material

Flammability rating according to UL 94	HB
Contact material	CuZn
Contact surface material	AU
Contact carrier material	PA 66
Material of grip body	TPU
Material, knurls	Zinc die-cast, nickel-plated

Standards and Regulations

Flame resistance	in acc. to UL VW1
	IEC 60332-1-2
Flammability rating according to UL 94	HB

Cable

Cable type	PUR/PVC gray
Cable type (abbreviation)	440
UL AWM style	20234 (80 °C / 600 V)
Conductor cross section	5x 1.5 mm ²
AWG signal line	16
Conductor structure, voltage supply	30x 0.25 mm
Wire colors	Black 1, black 2, black 3, black 4, green/yellow
Overall twist	5 cores, twisted
External sheath, color	gray RAL 7001
External cable diameter D	9.7 mm ±0.2 mm
Minimum bending radius, fixed installation	7.5 x D
Minimum bending radius, flexible installation	15 x D
Cable weight	140 kg/km
Outer sheath, material	PUR
Material conductor insulation	PVC
Conductor material	Bare Cu litz wires
Conductor resistance	13.3 Ω/km
Nominal voltage, cable	500 V AC
Test voltage, cable	4000 V AC
Flame resistance	According to EN 60332-1-2
	in acc. to UL VW1
	According to CSA FT1
Resistance to oil	According to HD 22.10
	according to VDE 0282 Part 10
Ambient temperature (operation)	-40 °C ... 90 °C (cable, fixed installation)

Power cable - SAC-5P- 3,0-440/MINFR PWR - 1443763

Technical data

Cable

	5 °C ... 90 °C (cable, flexible installation)
--	---

Classifications

eCl@ss

eCl@ss 4.0	27060306
eCl@ss 4.1	27060306
eCl@ss 5.0	27061801
eCl@ss 5.1	27061801
eCl@ss 6.0	27279218
eCl@ss 7.0	27279218
eCl@ss 8.0	27279218

ETIM

ETIM 2.0	EC000830
ETIM 3.0	EC001855
ETIM 4.0	EC001855
ETIM 5.0	EC001855

UNSPSC

UNSPSC 6.01	31251501
UNSPSC 7.0901	31251501
UNSPSC 11	31251501
UNSPSC 12.01	31251501
UNSPSC 13.2	31251501

Approvals

Approvals

Approvals

EAC

Ex Approvals

Approvals submitted

Approval details

Power cable - SAC-5P- 3,0-440/MINFR PWR - 1443763

Approvals

EAC

Drawings

Schematic diagram

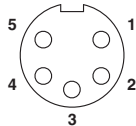

Pin assignment, socket, 7/8"-16UNF, 5-pos., view of female side

Cable cross section

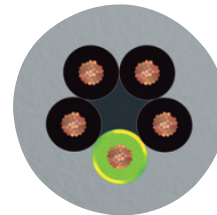

PUR/PVC gray [440]

Circuit diagram



Contact assignment of 7/8" socket

Dimensional drawing

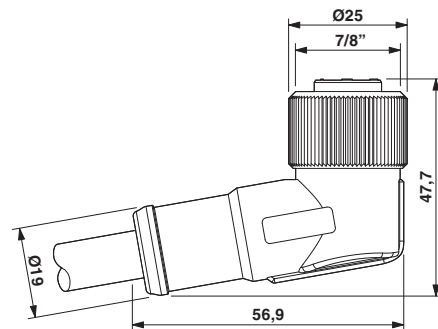

7/8"-16UNF socket, angled

Phoenix Contact 2016 © - all rights reserved
<http://www.phoenixcontact.com>

PHOENIX CONTACT GmbH & Co. KG
Flachsmarktstr. 8
32825 Blomberg
Germany
Tel. +49 5235 300
Fax +49 5235 3 41200
<http://www.phoenixcontact.com>

Below is a list of articles with direct links to our shop Electric Automation Network where you can see:

- Quote per purchase volume in real time.
- Online documentation and datasheets of all products.
- Estimated delivery time enquiry in real time.
- Logistics systems for the shipment of materials almost anywhere in the world.
- Purchasing management, order record and tracking of shipments.

To access the product, [click on the green button.](#)

Product	Code	Reference	Product link
Power cable, 5-position, PUR, gray RAL 7001, free cable end, on Socket angled 7/8"-16UNF, Cable length: 3 m, 1.5 mm ² conductor cross section, For power supply	1443763	SAC-5P-3,0-440/MINFR PWR	Buy on EAN