



Automatización Eléctrica
Especialistas en Automatización

At the end of this document you will find links to products related to this catalog. You can go directly to our shop by clicking [HERE](#). [HERE](#)

Sensor/actuator connector - SACC-M 8FS-3QO-0,5-M - 1441066

Please be informed that the data shown in this PDF Document is generated from our Online Catalog. Please find the complete data in the user's documentation. Our General Terms of Use for Downloads are valid (<http://phoenixcontact.com/download>)



Sensor/actuator connector, 3-position, Socket straight M8, A-coded, Insulation displacement connection, Knurl material: Zinc die-cast, nickel-plated, External cable diameter 2.5 mm ... 5 mm

Why buy this product

- Safe use in the field, thanks to a high degree of protection
- Flexible: connectors for on-site assembly
- Insulation displacement connection: innovative and time-saving assembly without stripping the single wire

Key Commercial Data

Packing unit	1 STK
GTIN	 4 046356 515955

Technical data

Dimensions

External cable diameter	2.5 mm ... 5 mm ±0.2 mm
Stripping length of the sheath	40 mm

Ambient conditions

Ambient temperature (operation)	-25 °C ... 80 °C (Plug / socket)
Degree of protection	IP65
	IP67

General

Rated current at 40°C	4 A
Rated voltage	60 V
Number of positions	3
Insulation resistance	≥ 100 MΩ
Coding	A - standard
Standards/regulations	M8 connector IEC 61076-2-104
Status display	No
Overvoltage category	II
Degree of pollution	3
Connection method	Insulation displacement connection

Sensor/actuator connector - SACC-M 8FS-3QO-0,5-M - 1441066

Technical data

General

Conductor cross section	0.25 mm ² ... 0.5 mm ²
Conductor cross section AWG	24 ... 20
Wire diameter including insulation	1.1 mm ... 1.55 mm
Frequency of connections between conductors of the same cross section	10
Wire insulation material	PVC / PE / PP / rubber
Structure of individual litz in acc. with VDE 0295 / smallest wire diameter	Class 2-6
Insertion/withdrawal cycles	≥ 100
Torque	0.6 Nm (Pressure nut)
	0.2 Nm (M8 knurl)

Material

Flammability rating according to UL 94	HB
Contact material	CuSn
Contact surface material	Ni/Au
Contact carrier material	TPU GF
Material of grip body	PA 6
Material, knurls	Zinc die-cast, nickel-plated
Sealing material	NBR

Standards and Regulations

Standard designation	M8 connector
Standards/regulations	IEC 61076-2-104
Connection in acc. with standard	CUL
Flammability rating according to UL 94	HB

Classifications

eCl@ss

eCl@ss 4.0	27140815
eCl@ss 4.1	27140815
eCl@ss 5.0	27143423
eCl@ss 5.1	27143423
eCl@ss 6.0	27279221
eCl@ss 7.0	27440104
eCl@ss 8.0	27440104
eCl@ss 9.0	27440102

ETIM

ETIM 2.0	EC001121
ETIM 3.0	EC002062
ETIM 4.0	EC002062

Sensor/actuator connector - SACC-M 8FS-3QO-0,5-M - 1441066

Classifications

ETIM

ETIM 5.0	EC002062
----------	----------

UNSPSC

UNSPSC 6.01	30211824
UNSPSC 7.0901	39121413
UNSPSC 11	39121413
UNSPSC 12.01	39121413
UNSPSC 13.2	39121413

Approvals

Approvals

Approvals

UL Recognized / cUL Recognized / EAC / EAC / cULus Recognized

Ex Approvals

Approvals submitted

Approval details

UL Recognized	
mm ² /AWG/kcmil	24-20
Nominal current I _N	4 A
Nominal voltage U _N	29 V

cUL Recognized	
mm ² /AWG/kcmil	24-20
Nominal current I _N	4 A
Nominal voltage U _N	29 V

EAC

Sensor/actuator connector - SACC-M 8FS-3QO-0,5-M - 1441066

Approvals

EAC

cULus Recognized

Drawings

Schematic diagram

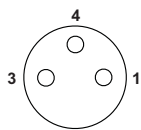

Pin assignment of M8 socket, 3-pos., view of pin side

Dimensional drawing

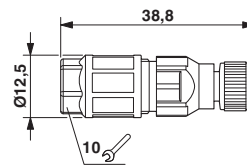

Socket M8 x 1, straight

Functional drawing

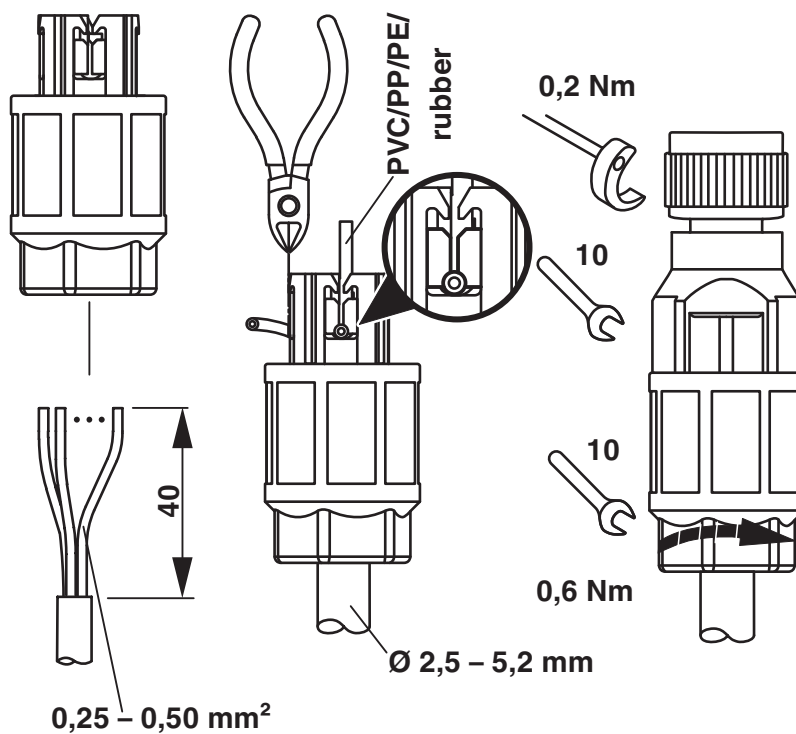

Phoenix Contact 2016 © - all rights reserved
<http://www.phoenixcontact.com>

PHOENIX CONTACT GmbH & Co. KG
Flachsmarktstr. 8
32825 Blomberg
Germany
Tel. +49 5235 300
Fax +49 5235 3 41200
<http://www.phoenixcontact.com>

Below is a list of articles with direct links to our shop Electric Automation Network where you can see:

- Quote per purchase volume in real time.
- Online documentation and datasheets of all products.
- Estimated delivery time enquiry in real time.
- Logistics systems for the shipment of materials almost anywhere in the world.
- Purchasing management, order record and tracking of shipments.

To access the product, [click on the green button.](#)

Product	Code	Reference	Product link
Sensor/actuator connector, 3-position, Socket straight M8, A-coded, Insulation displacement connection, Knurl material: Zinc die-cast, nickel-plated, External cable diameter 2.5 mm ... 5 mm	1441066	SACC-M 8FS-3QO-0,5-M	Buy on EAN