

ZX-L-N Series

**Smart Sensors**  
**Laser Type**

**USER'S MANUAL**

**OMRON**

Introduction	<b>APPLICATION CONSIDERATIONS</b> (Please Read)	Introduction
Section 1	FEATURES	Section 1
Section 2	PREPARATION FOR MEASUREMENT	Section 2
Section 3	BASIC OPERATION	Section 3
Section 4	MAIN APPLICATIONS AND SETTING METHODS	Section 4
Section 5	DETAILED SETTINGS	Section 5
Section 6	AUXILIARY FUNCTIONS	Section 6
Section 7	APPENDIX	Section 7

# User's Manual

Smart Sensors  
ZX-L-N Series

# Introduction

Thank you for purchasing the ZX-L-N Series Smart Sensor. This manual provides information regarding functions, performance and operating methods that are required for using the sensor.

When using the ZX-L-N Smart Sensor, make sure to observe the following:

- The ZX-L-N Smart Sensor must be operated by personnel knowledgeable in electrical engineering.
- To ensure correct use, please read this manual thoroughly to deepen your understanding of the product.
- Please keep this manual in a safe place so that it can be referred to whenever necessary.

## **READ AND UNDERSTAND THIS DOCUMENT**

Please read and understand this document before using the products. Please consult your OMRON representative if you have any questions or comments.

## **WARRANTY**

OMRON's exclusive warranty is that the products are free from defects in materials and workmanship for a period of one year (or other period if specified) from date of sale by OMRON.

OMRON MAKES NO WARRANTY OR REPRESENTATION, EXPRESS OR IMPLIED, REGARDING NON-INFRINGEMENT, MERCHANTABILITY, OR FITNESS FOR PARTICULAR PURPOSE OF THE PRODUCTS. ANY BUYER OR USER ACKNOWLEDGES THAT THE BUYER OR USER ALONE HAS DETERMINED THAT THE PRODUCTS WILL SUITABLY MEET THE REQUIREMENTS OF THEIR INTENDED USE. OMRON DISCLAIMS ALL OTHER WARRANTIES, EXPRESS OR IMPLIED.

## **LIMITATIONS OF LIABILITY**

OMRON SHALL NOT BE RESPONSIBLE FOR SPECIAL, INDIRECT, OR CONSEQUENTIAL DAMAGES, LOSS OF PROFITS OR COMMERCIAL LOSS IN ANY WAY CONNECTED WITH THE PRODUCTS, WHETHER SUCH CLAIM IS BASED ON CONTRACT, WARRANTY, NEGLIGENCE, OR STRICT LIABILITY.

In no event shall responsibility of OMRON for any act exceed the individual price of the product on which liability is asserted.

IN NO EVENT SHALL OMRON BE RESPONSIBLE FOR WARRANTY, REPAIR, OR OTHER CLAIMS REGARDING THE PRODUCTS UNLESS OMRON'S ANALYSIS CONFIRMS THAT THE PRODUCTS WERE PROPERLY HANDLED, STORED, INSTALLED, AND MAINTAINED AND NOT SUBJECT TO CONTAMINATION, ABUSE, MISUSE, OR INAPPROPRIATE MODIFICATION OR REPAIR.

## **SUITABILITY FOR USE**

THE PRODUCTS CONTAINED IN THIS DOCUMENT ARE NOT SAFETY RATED. THEY ARE NOT DESIGNED OR RATED FOR ENSURING SAFETY OF PERSONS, AND SHOULD NOT BE RELIED UPON AS A SAFETY COMPONENT OR PROTECTIVE DEVICE FOR SUCH PURPOSES. Please refer to separate catalogs for OMRON's safety rated products.

OMRON shall not be responsible for conformity with any standards, codes, or regulations that apply to the combination of products in the customer's application or use of the product.

At the customer's request, OMRON will provide applicable third party certification documents identifying ratings and limitations of use that apply to the products. This information by itself is not sufficient for a complete determination of the suitability of the products in combination with the end product, machine, system, or other application or use.

The following are some examples of applications for which particular attention must be given. This is not intended to be an exhaustive list of all possible uses of the products, nor is it intended to imply that the uses listed may be suitable for the products:

Outdoor use, uses involving potential chemical contamination or electrical interference, or conditions or uses not described in this document.

Nuclear energy control systems, combustion systems, railroad systems, aviation systems, medical equipment, amusement machines, vehicles, safety equipment, and installations subject to separate industry or government regulations.

Systems, machines, and equipment that could present a risk to life or property.

Please know and observe all prohibitions of use applicable to the products.

NEVER USE THE PRODUCTS FOR AN APPLICATION INVOLVING SERIOUS RISK TO LIFE OR PROPERTY WITHOUT ENSURING THAT THE SYSTEM AS A WHOLE HAS BEEN DESIGNED TO ADDRESS THE RISKS, AND THAT THE OMRON PRODUCT IS PROPERLY RATED AND INSTALLED FOR THE INTENDED USE WITHIN THE OVERALL EQUIPMENT OR SYSTEM.

## **PERFORMANCE DATA**

Performance data given in this document is provided as a guide for the user in determining suitability and does not constitute a warranty. It may represent the result of OMRON's test conditions, and the users must correlate it to actual application requirements. Actual performance is subject to the OMRON Warranty and Limitations of Liability.

## **CHANGE IN SPECIFICATIONS**

Product specifications and accessories may be changed at any time based on improvements and other reasons.

It is our practice to change model numbers when published ratings or features are changed, or when significant construction changes are made. However, some specifications of the product may be changed without any notice. When in doubt, special model numbers may be assigned to fix or establish key specifications for your application on

your request. Please consult with your OMRON representative at any time to confirm actual specifications of purchased products.

### **DIMENSIONS AND WEIGHTS**

Dimensions and weights are nominal and are not to be used for manufacturing purposes, even when tolerances are shown.

### **ERRORS AND OMISSIONS**

The information in this document has been carefully checked and is believed to be accurate; however, no responsibility is assumed for clerical, typographical, or proofreading errors, or omissions.

### **PROGRAMMABLE PRODUCTS**

OMRON shall not be responsible for the user's programming of a programmable product, or any consequence thereof.

### **COPYRIGHT AND COPY PERMISSION**

This document shall not be copied for sales or promotions without permission.

This document is protected by copyright and is intended solely for use in conjunction with the product. Please notify us before copying or reproducing this document in any manner, for any other purpose. If copying or transmitting this document to another, please copy or transmit it in its entirety.

## Meanings of Signal Words

The following signal words are used in this manual.



**WARNING**

Indicates a potentially hazardous situation which, if not avoided, will result in minor or moderate injury, or may result in serious injury or death. Additionally there may be significant property damage.



**CAUTION**

Indicates a potentially hazardous situation which, if not avoided, may result in minor or moderate injury or in property damage.

## Meanings of Alert Symbols

The following alert symbols are used in this manual.



Indicates the possibility of laser radiation.



Indicates prohibition when there is a risk of minor injury from electrical shock or other source if the product is disassembled.

## Laser Safety

### ■ ZX-LD□□□/ZX-LD30V□ Reflective Sensor Type Sensor Head

#### WARNING

Never look into the laser beam.  
Doing so continuously will result in visual impairment.



Do not disassemble the product.  
Doing so may cause the laser beam to leak, resulting in the danger  
of visual impairment.



### ■ ZX-LT□□□ Through-beam Type Sensor Head

#### CAUTION

Do not look into the laser beam.  
Doing so continuously may result in visual impairment.

The ZX-LD□□, ZX-LD□□L, ZX-LD□□V, and ZX-LD□□VL Sensor Heads are Class 2 Laser Products according to EN 60825-1 (IEC 60825-1) and Class II Laser Products according to FDA (21 CFR1040.10) (see note). The ZXLT□□ Sensor Heads are Class 1 and Class II Laser Products, respectively. The ZX Series is meant to be built into final system equipment. Pay special attention to the following precautions for the safe use of the product:

**Note:** Europe: Class 1 and Class 2 of EN 60825-1: 1994 +A11:1996 +A2:2001  
= IEC 60825-1:1993 +A1:1997 +A2:2001  
U.S.A.: Class I and Class II of FDA (21 CFR1040.10)

As for the Laser Product Classifications, refer to the Appendix,

 p.155

- (1) ZX-LD□□□/ZX-LD30V□ emits visual laser beam. Do not stare directly into the laser.  
Make sure that the laser beam path is terminated. If specular objects are present in the laser beam path, make sure that they are prevented from reflecting the laser beam.  
When used without an enclosure, make sure the laser path from eye level is avoided.
- (2) To avoid exposure to hazardous laser radiation, do not displace nor remove the protective housing during operation, maintenance, and any other servicing.
- (3) As for countries other than those of Europe and the U.S.A., observe the regulations and standards specified by each country.
- (4) Label Indications  
The EN and FDA labels are supplied with the product.  
Replace the current labels with them according to the instructions given in the manuals.



## Precautions for Safe Use

Please observe the following precautions for safe use of the products.

### ■ Installation Environment

- Do not use the product in environments where it can be exposed to inflammable/explosive gas.
- Do not install the product close to high-voltage devices and power devices in order to secure the safety of operation and maintenance.

### ■ Power Supply and Wiring

- The supply voltage must be within the rated range (DC12 to 24V±10%).
- Reverse connection of power supply is not allowed. Connection to AC power supply is also not allowed.
- Open-collector outputs should not be short-circuited.
- High-voltage lines and power lines must be wired separately from this product. Wiring them together or placing in the same duct may cause induction, resulting in malfunction or damage.
- Always turn off the power supply before connecting or disconnecting cables and connectors.

### ■ Others

- ZX-E series (linear proximity type), and ZX-W series (microwave type) and ZX-T series (high-precision contact type) must not be connected. Combined use of ZX-L with these series is not allowed.
- Do not attempt to dismantle, repair, or modify the product.
- Dispose of this product as industrial waste.

## Precautions for Correct Use

Please observe the following precautions to prevent failure to operate, malfunctions, or undesirable effects on product performance.

### Installation of the Product

#### ■ Installation Site

Do not install the product in locations subjected to the following conditions:

- Ambient temperature outside the rating
- Rapid temperature fluctuations (causing condensation)
- Relative humidity outside the range of 35 to 85%
- Presence of corrosive or flammable gases
- Presence of dust, salt, or iron particles
- Direct vibration or shock
- Reflective sensor of intense light (such as other laser beams or electric arc-welding machines)
- Direct sunlight or near heaters
- Water, oil, or chemical fumes or spray
- Strong magnetic or electric field

### Component Installation and Handling

#### ■ Power Supply and Wiring

- To extend the output cables of Amplifier Units, shielded cables of the same specifications as the output cables must be used.
- When using a commercially available switching regulator, make sure that the FG terminal is grounded.
- If surge currents are present in the power lines, connect surge absorbers that suit the operating environment.
- When using two or more amplifier units, make sure that the linear GND line of the amplifier units are connected to each other.
- Before turning ON the power after the product is connected, make sure that the power supply voltage is correct, there are no incorrect connections (e.g. load short-circuit) and the load current is appropriate. Incorrect wiring may result in breakdown of the product.
- The cables must be 10m or shorter in total length, for both sensor head and amplifier units. To extend the cable from the sensor head, an optional extension cable (ZX-XC□A) must be used. For extension of the cable of amplifier units, shielded cables of the same type must be used.
- When using calculation units, make sure that the linear GND lines of the amplifier units are connected to each other.

## ■ Warming Up

After turning ON the power supply, allow the product to stand for at least 10 minutes before use. The circuits are still unstable just after the power supply is turned ON, so measured values may fluctuate gradually.

## ■ Maintenance and Inspection

- Always turn OFF the power supply before adjusting or connecting/disconnecting the sensor head.
- Do not use thinner, benzene, acetone or kerosene to clean the sensor head and amplifier units. If large dust particles adhere to the front filter of the sensor head, use a blower brush (used to clean camera lenses) to blow them off. Do not blow the dust away with your mouth. To remove smaller dust particles, use a soft cloth (for lenses) with a small amount of alcohol. Take care not to wipe them off with excessive force. Scratches on the filter may cause errors.

## ■ Sensing Object For Reflective Type Sensor Head

The product cannot accurately measure the following types of objects: Transparent objects, objects with an extremely low reflective sensor ratio, objects smaller than the spot diameter, objects with a large curvature, excessively inclined objects, etc.

## ■ Mutual Interference

Inserting a calculation unit between amplifier units can prevent mutual interference between two sensor heads. However, this may not work efficiently if one sensor head is saturated and a laser beam of the other sensor head is input. If you are interested in installing a calculation unit in order to prevent mutual interference, carry out a test using the actual system beforehand.

# Editor's Note

## Page Format

**Section 6  
AUXILIARY FUNCTIONS**

### Measuring with Multiple Amplifier Units

This section describes the settings when Calculating Units are used to connect multiple Amplifier Units.

#### Performing Calculations

Measurement results can be calculated between 2 Amplifier Units. The expression is set on the CH2 Amplifier Unit and the calculation results are also output from the CH2 Amplifier Unit. Calculations can also be performed between Sensors with different measuring ranges.

**CHECK!** The response time of the CH2 Amplifier Unit to which an expression is set will be prolonged by 1.0ms. Since the response time is influenced by the number of samples to average, the actual response time will be "response time based on the number of samples to average + 1.0ms"

Setting the Number of Samples to Average p.66

#### Adding and Subtracting Measurement Results

Moving to FUN and CALC

1. Set the mode switch to FUN on the CH2 Amplifier Unit.
2. Use the LEFT and RIGHT Keys to display [CALC] on the main display.
3. Press the UP or DOWN Key. The sub-display will flash.
4. Use the UP or DOWN Key to select the desired expression.
5. Press the ENT Key to confirm the setting. The setting will be registered.

**Section 6  
AUXILIARY FUNCTIONS**

ZX-L  
Operation Manual | 123

- Title of each section
- Header
- Indicates the contents of the page.
- Overview
- Describes the overview and operation flow of the section.
- Cross-header
- Overview and points of the function described
- Sub-header
- Purpose of operation
- Shows the contents of the operation to be performed.
- Index label
- Shows the chapter number and contents.
- Display
- Shows the display status resulting from the operation.
- Keys or switches to be used
- Illustrates the keys and switches to be used.
- Operation procedure and supplementary explanation
- Explains the operation procedure and the display status resulting from execution of the operation. Helpful information regarding operation and reference pages is introduced here using symbols.

\* This page does not exist.

## Notational Conventions

---

### ■ Menu

In this manual, menu items displayed on the screen are enclosed with [ ].

---

### ■ Operation procedure

Operation steps are numbered to indicate their order.

---

### ■ Visual Aids



Indicates points that are important to achieve the full product performance, such as operational precautions and application procedures.



Indicates pages where related information can be found.



Indicates information helpful in operation.

# Contents

---

<b>Introduction</b>	<b>ii</b>
Precautions on Safety	v
Laser Safety	vi
Precautions for Safe Use	viii
Precautions for Correct Use	ix
Editor's Note	xi
Contents	xiii

<b>Section 1 FEATURES</b>	<b>1</b>
ZX-L Features	2

<b>Section 2 PREPARATION FOR MEASUREMENT</b>	<b>9</b>
Basic Configuration	10
Part Names and Functions	11
Installing the Amplifier Unit	16
Installing Sensor Heads	18
Connections	21
Wiring Input/Output Cables	27

<b>Section 3 BASIC OPERATION</b>	<b>31</b>
Flow of Operation	32
Basic Knowledge for Operation	34
Function Transition Charts	39
Setting the Auto Scale	42
Setting the Standard Received Light Amount	45
Measuring the Received Light Amount (Intensity Mode)	46
<b>Section 4 MAIN APPLICATIONS AND SETTING METHODS</b>	<b>49</b>
Measuring Height	50
Measuring Thickness	54
Measuring Eccentricity and Vibration	58
Measuring Edges	61
<b>Section 5 DETAILED SETTINGS</b>	<b>65</b>
Setting Number of Samples to Average	66
Changing Display Scales	67
Setting the Measurement Sensitivity (Gain Switching)	74
Using Hold Functions	76
Comparing Measured Values (Differentiation Function)	83
Comparing Measured Values (Previous Value Comparisons)	86
Entering Threshold Values	88
Linear Output	95
Setting Judgement Output Timing (Timer)	104

<b>Section 6 AUXILIARY FUNCTIONS</b>	<b>107</b>
Measuring with Multiple Amplifier Units	108
Changing the Number of Display Digits	112
Reversing the Display	113
Adjusting Display Brightness (ECO Display)	115
Using the Zero Reset Function	116
Key Lock Function	122
Initializing Settings Data	123

<b>Section 7 APPENDIX</b>	<b>125</b>
Troubleshooting	126
Error Messages and Countermeasures	127
Q&A	129
Glossary	130
Specifications and Dimensions	132
Communication with the Smart Monitor is possible via the Interface Unit	144
Engineering Data	146
Quick Reference for Displays	152
Requirements from Regulations and Standards	155
Index	164
Revision History	168



MEMO

# Section 1

## FEATURES

 ZX-L Features

---

2

# ZX-L Features

The ZX-L Series provide the reflective type for displacement measurement and through-beam type for smart length measurement. Measurement is performed using laser. By irradiating laser beams to the object, the sensor can measure the distance between the object and sensor head, perform positioning and width judgement.

Example: Measuring the height of a PCB mold

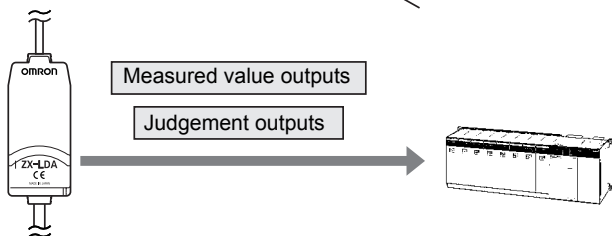
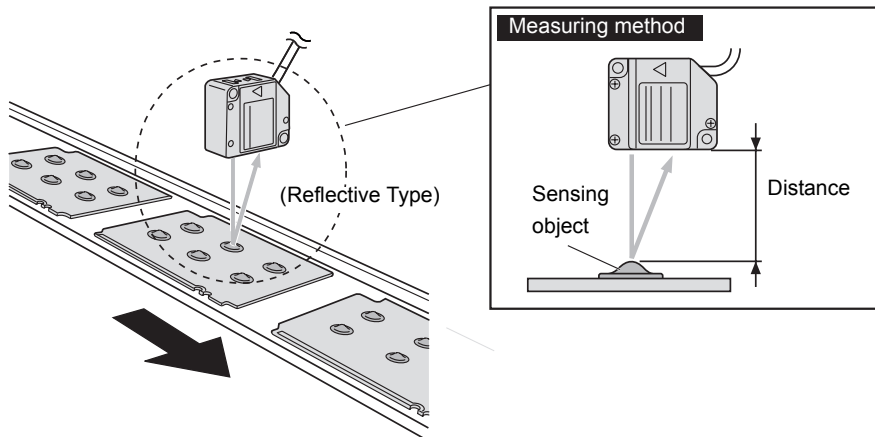

Example: Detecting cap floating

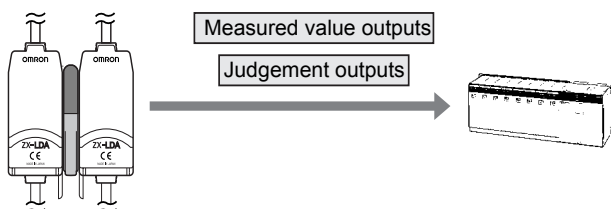
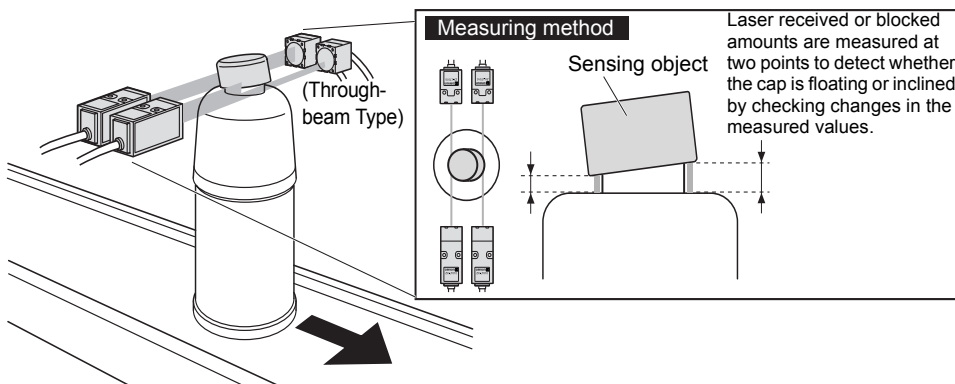

## The Compact Body Provides Sufficient Space.

The ZX-L series come in units as small as photoelectric sensors. This enables effective use of limited installation space.

## Many, Simple Functions

### ■ Measurement Ready at Power ON

The sensor can be used simply by installing and wiring it. Simply turn ON the power and it is ready to operate.

The measurement results are displayed on the Amplifier Unit.

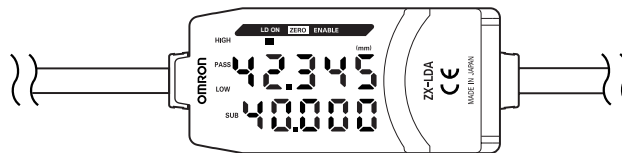

### ■ Simple Calculation Settings

Use a Calculating Unit to simply measure thickness and sum and difference calculations between two measurements.

 p.108

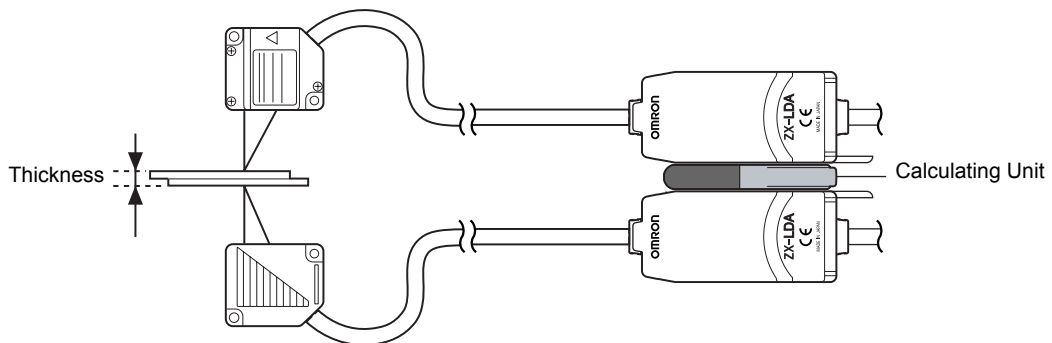

## Mutual Interference Prevention for Closely Mounted Sensor Heads

The sensor has a mutual interference prevention function which allows multiple Sensor Heads to be mounted close to each other.

This function is supported for up to two Sensor Heads by using ZX-CAL2 Calculating Units.

 p.24

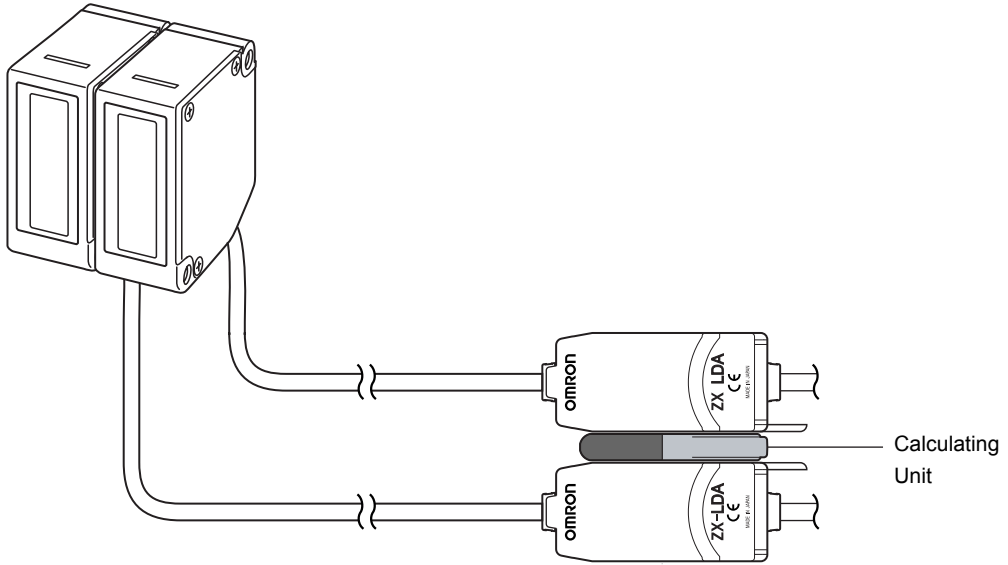

## Compatibility between Sensor Heads and Amplifier Units

Amplifier Units do not need to be changed when Sensor Heads are changed for maintenance or to switch to new products.

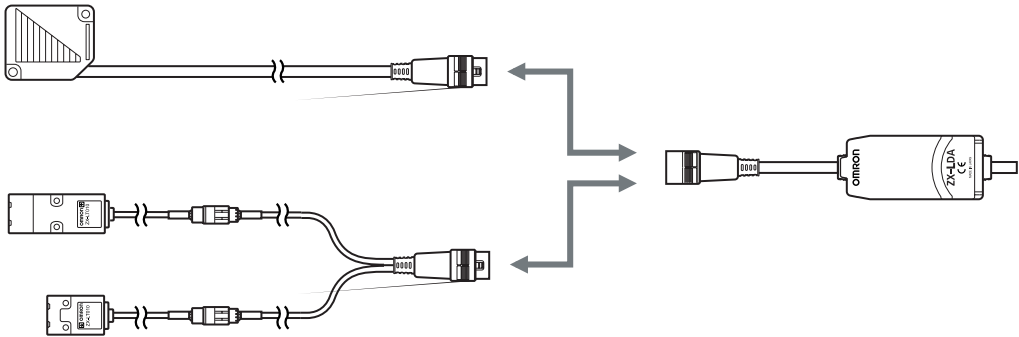

## Extendable Sensor Head Cables

Special extension cables are provided to extend sensor heads.

 p.10

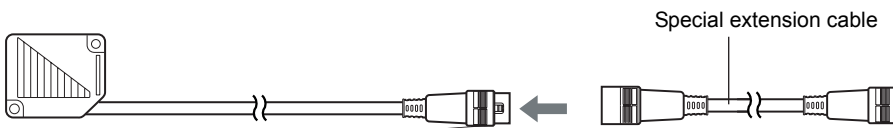

## Monitoring Measurement Status

### ■ Resolution Display for Sensing Object

The resolution can be displayed, allowing judgements to be made about detection margins while viewing the resolution value.

 p.39

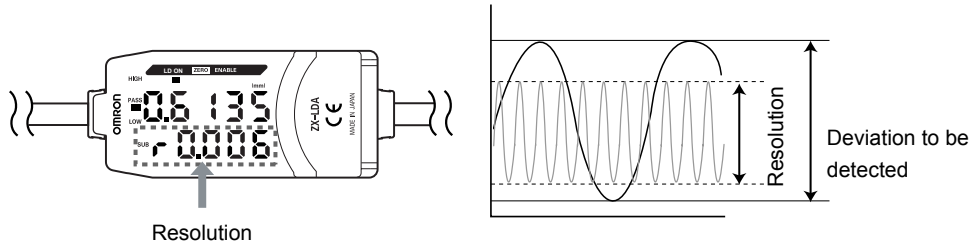

### ■ Confirm Measurement Status on a Personal Computer

Use an Interface Unit and Smart Monitor to view measurement waveforms and log measurement data on a personal computer. This function is useful for making on-site measurement adjustments and for day-to-day quality control.

 p.15, p.144

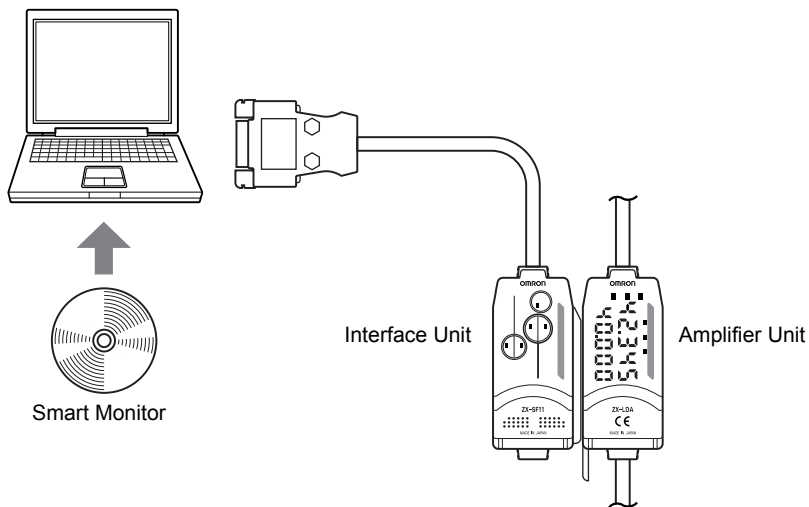

## Useful Warning Functions

### ■ Built-in Laser Life Monitor

When the laser of Sensor Head deteriorates, [LDDWN] will appear for approx. five seconds on the Main Display when the power is turned ON. This assists in understanding when the Sensor Head should be replaced with a new one.

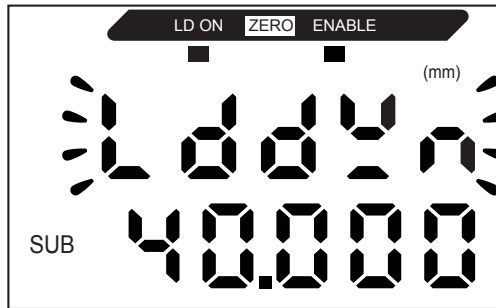



MEMO

# Section 2

## PREPARATION FOR MEASUREMENT

❑ Basic Configuration	10
❑ Part Names and Functions	11
❑ Installing the Amplifier Unit	16
❑ Installing Sensor Heads	18
❑ Connections	21
❑ Wiring Input/Output Cables	27

# Basic Configuration

The basic configuration of the ZX-L series Smart Sensors is shown below.



ZX-L series Smart Sensors are not compatible with other ZX series Smart Sensors. ZX-L cannot be used with ZX-E, ZX-W and ZX-T series Smart Sensors.

CHECK!

**Smart Monitor (Software)**

ZX-SW11  
(Ver 3.0 or later)

Enables operation of Amplifier Units from the personal computer and monitoring measured values.



**Personal Computer**



**Connecting Cable**

Commercially available cross cable

p.142

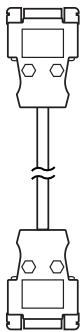

**Interface Unit**

ZX-SF11  
(Ver 2.0 or later)

Used to connect to a personal computer or programmable controller.

p.26

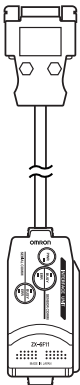

**Basic Configuration**

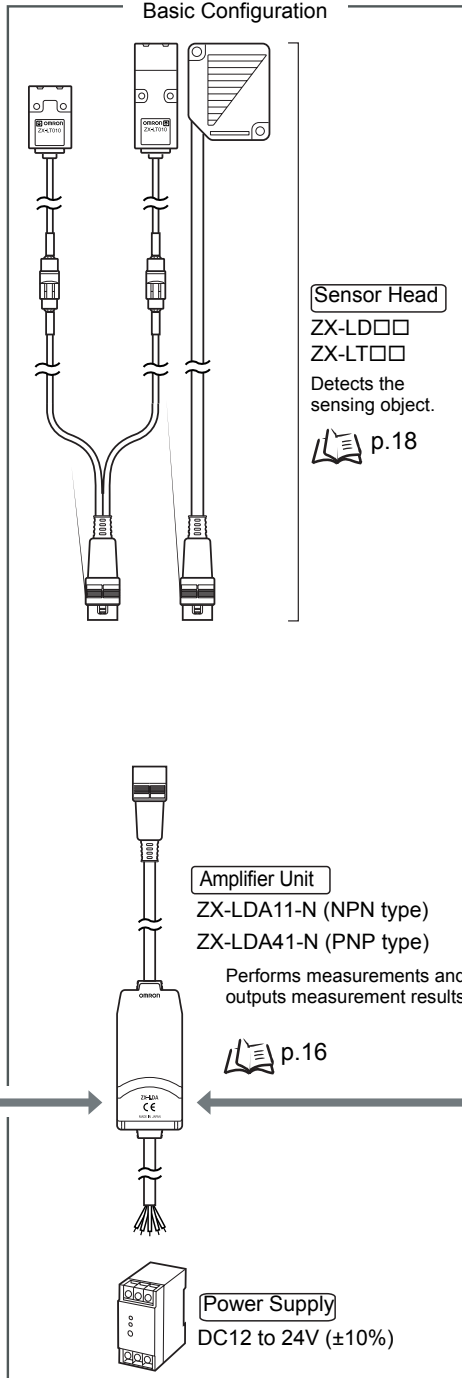

**Sensor Head**

ZX-LD□□  
ZX-LT□□

Detects the sensing object.

p.18



**Extension Cable**

ZX-XC1A(1m)  
ZX-XC4A(4m)  
ZX-XC8A(8m)  
ZX-XC9(9m)

To be used between a Sensor Unit and Amplifier Unit. Only one extension cable can be used. ZX-XC9 can be used for ZX-LD only.

**Amplifier Unit**

ZX-LDA11-N (NPN type)  
ZX-LDA41-N (PNP type)

Performs measurements and outputs measurement results.

p.16

**Calculating Unit**

ZX-CAL2

Used to connect two or more Amplifier Units.

- Calculation
- Mutual interference prevention

p.24

**Power Supply**

DC12 to 24V (±10%)

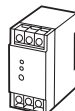

# Part Names and Functions

## Amplifier Unit

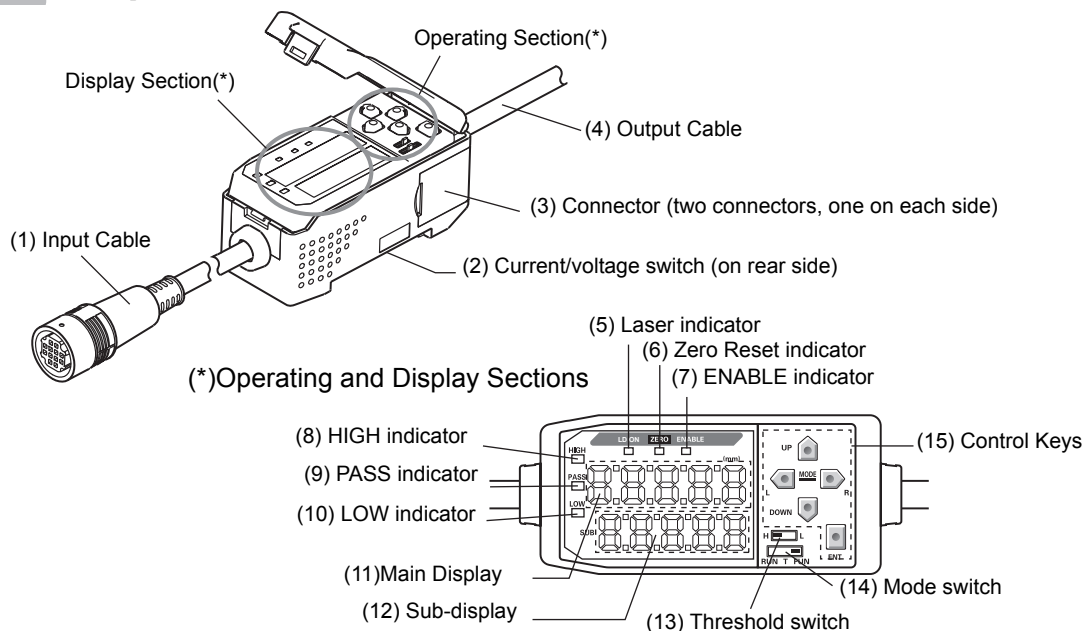

- (1) The input cable connects the Sensor Head.
- (2) The current/voltage switch selects either a current or voltage linear output.

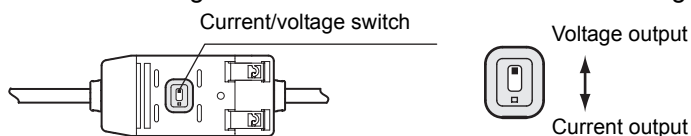

- (3) Monitor focus settings are also required when switching the output. p.95
- (3) The connectors connect Calculation and Interface Units.
- (4) The output cable connects the sensor to the power supply and external devices, such as sync sensors or programmable controllers.
- (5) The Laser indicator lights while the Sensor Head is emitting a laser beam.
- (6) The Zero Reset indicator lights when the zero reset function is enabled.
- (7) The ENABLE indicator lights when the Sensor is ready for measurement. It goes off when measurement is not possible (e.g. when the received light amount is excessive or insufficient, when the measuring range is exceeded, or when the Sensor Head is not connected when the power is turned ON).
- (8) The HIGH indicator lights when the judgement result is HIGH.
- (9) The PASS indicator lights when the judgement result is PASS.
- (10) The LOW indicator lights when the judgement result is LOW.
- (11) The main display shows measured values and function names.
- (12) The sub-display shows additional information and function settings for measurements. Reading Displays p.35
- (13) The threshold switch selects whether to set (and display) the HIGH or LOW threshold.
- (14) The mode switch selects the operating mode. Switching Modes p.34
- (15) The Control Keys set measurement conditions and make other settings. Key Operations p.36

## Sensor Head

### ■ Reflective type sensor head

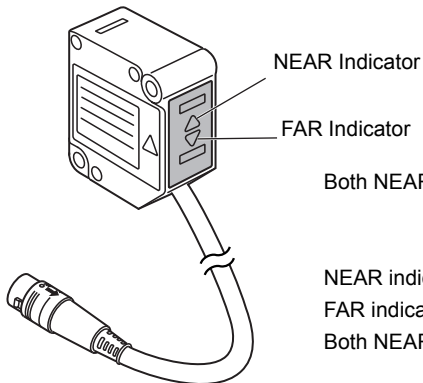
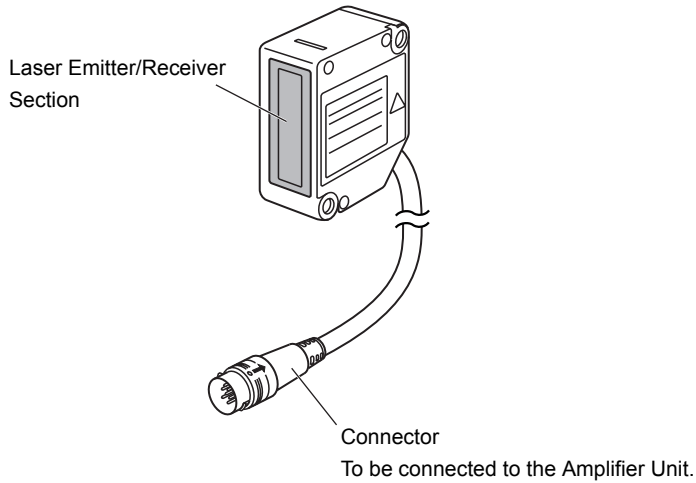

Both NEAR and FAR indicators are lit:

Measuring center distance  
(Measuring range x 10%)

NEAR indicator is lit: Near side within measuring range

FAR indicator is lit: Far side within measuring range

Both NEAR and FAR indicators are blinking:

Outside measuring range

■ Through-beam Type Sensor Head

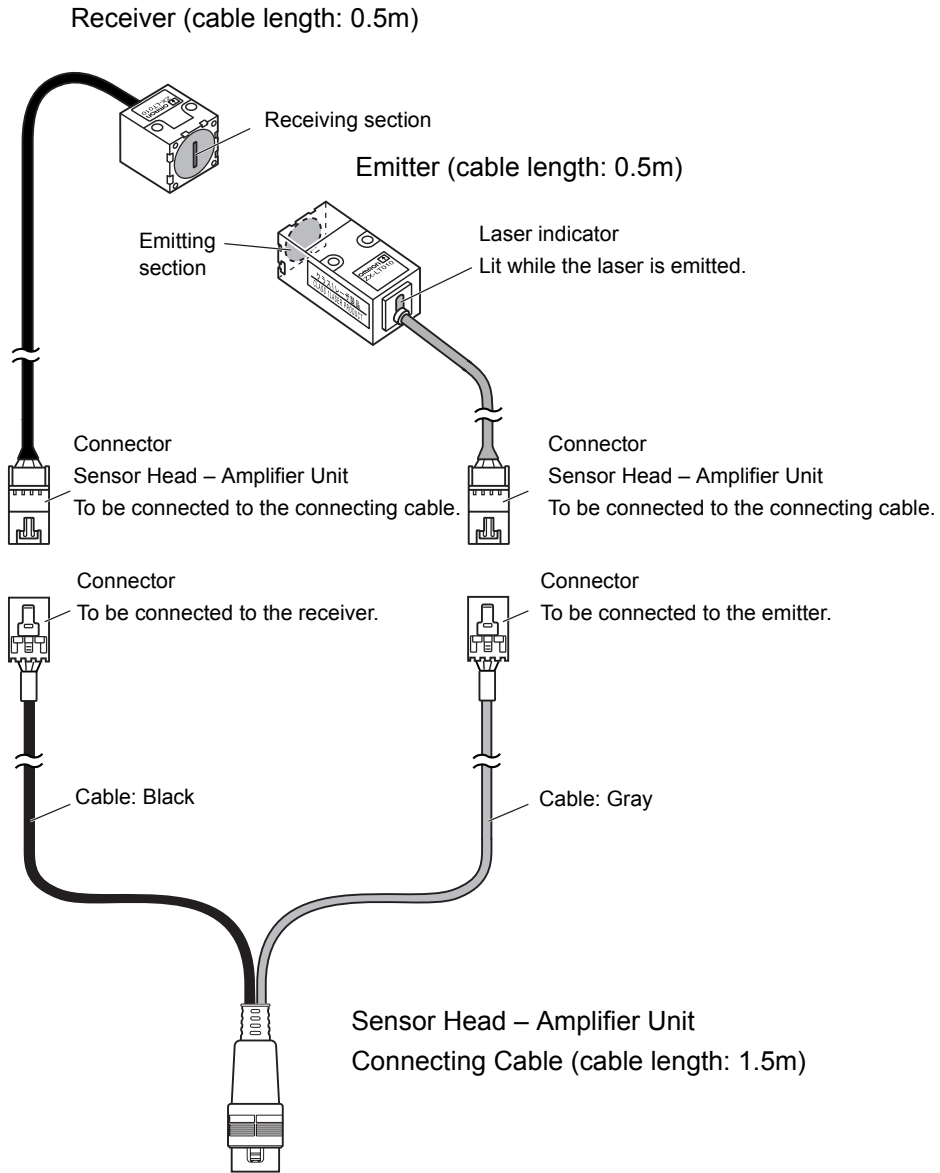

Side View Attachment

Used to change the mount direction.

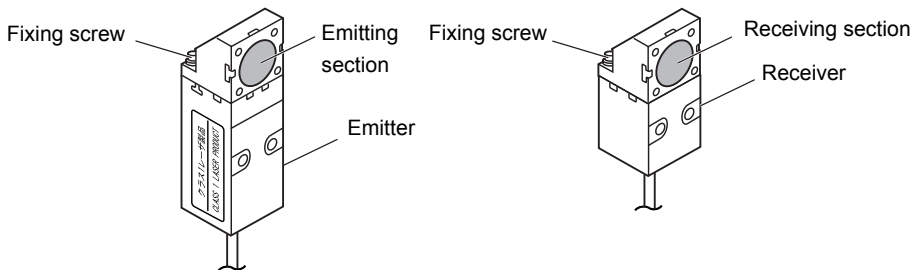

## Calculating Units

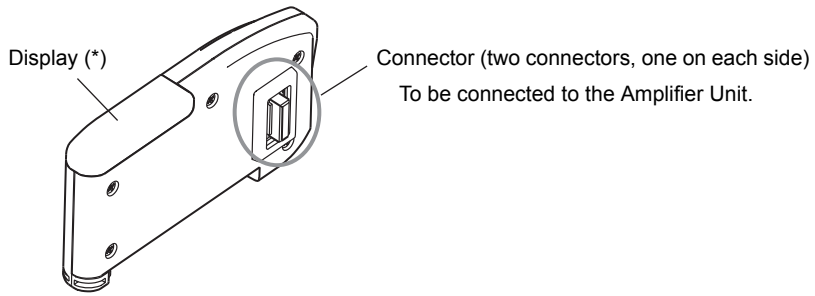

### \* Display Detail

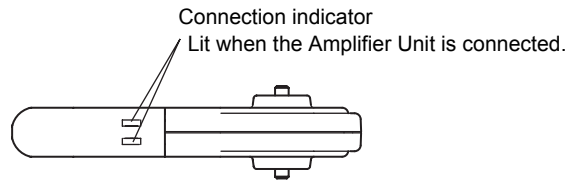

## Interface Units

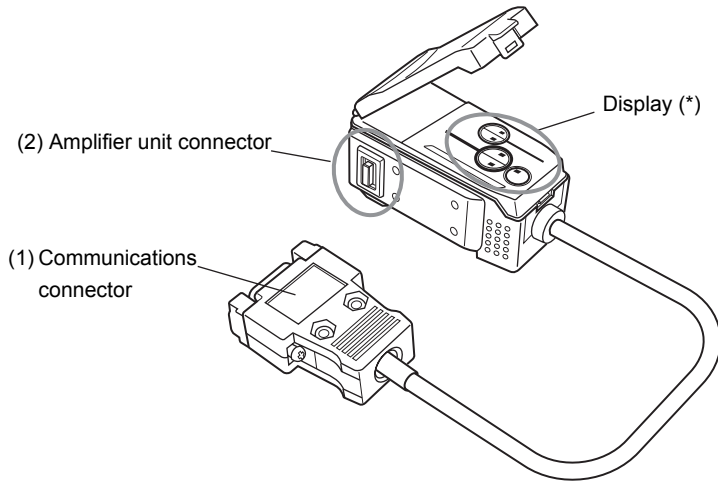

\* Display Detail

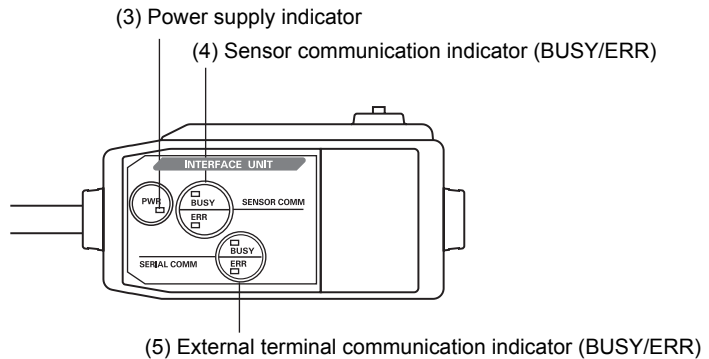

- (1) The communications connector connects the communications cable to the computer.
- (2) The Amplifier Unit connector connects to the Amplifier Unit.
- (3) The power supply indicator lights while the power is supplied.
- (4) BUSY: Lights during communications with the Smart Sensor.  
ERR: Lights if an error occurs during communications with the Smart Sensor.
- (5) BUSY: Lights during communications with the personal computer.  
ERR: Lights if an error occurs during communications with the personal computer.



# Installing the Amplifier Unit

Amplifier Units can be easily mounted to 35-mm DIN Track.

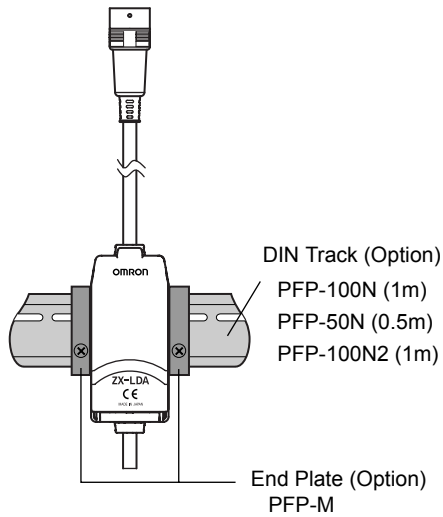

## ■ Installation

Hook the connector end of the Amplifier Unit on the DIN Track and press in at the bottom until the Unit locks into place.

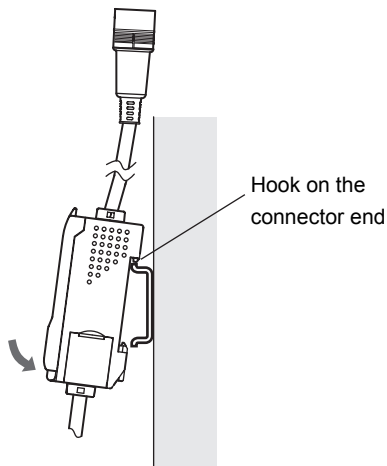

Always hook the connector end of the Amplifier Unit on the DIN Track first. Mounting strength may decrease if the output cable end is hooked on the DIN Track first.

CHECK!

■ Removal Method

Push the Amplifier Unit up and pull out from the connector end.

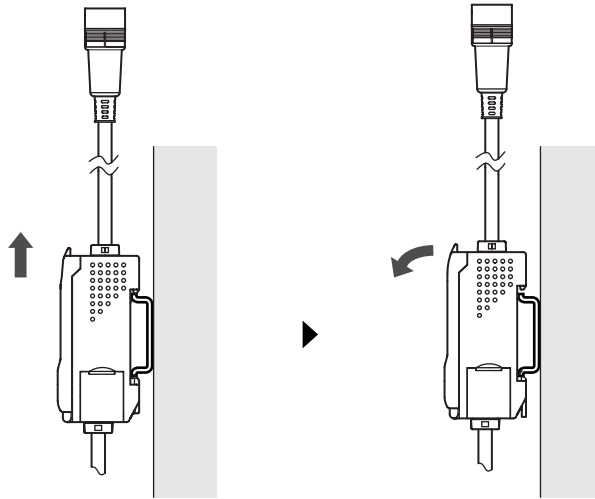

# Installing Sensor Heads

This section describes how to install Sensor Heads. The installation method varies between the Reflective Type and Through-beam Type Sensor Heads.

## Reflective Type Sensor Head

### Installation

Fix the Reflective type sensor head with screws.

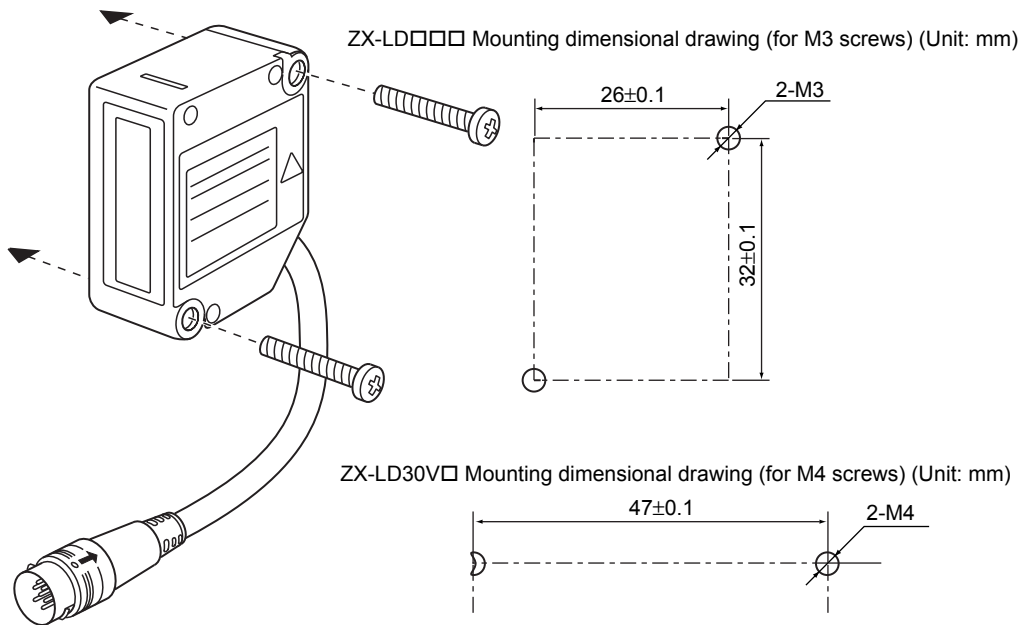

When mounting a Sensor Head, take care not to touch the emitter and receiver. Adhesion of finger marks may hinder correct measurements. If you have touched them, wipe them with a clean, soft cloth.

CHECK!

## Through-beam Type Sensor Head

### ■ Installation

Fix the through-beam type sensor head with M3 screws. The screws must be tightened with a torque of 0.3N•m or lower.

ZX-LT001/LT005

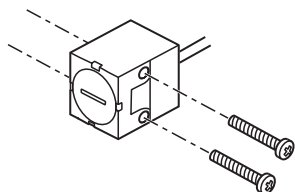

ZX-LT001/LT005 Mounting dimensional drawing (same for both emitter and receiver)  
(Unit: mm)

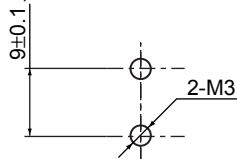

ZX-LT010

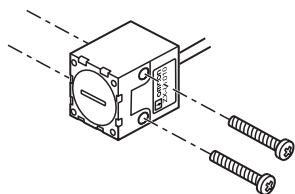

ZX-LT010 Mounting dimensional drawing (same for both emitter and receiver) (Unit: mm)

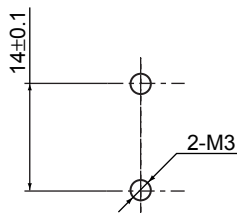

CHECK!

Make sure that the emitter and receiver are mounted in the correct direction as shown below. Mounting them in the wrong direction will hinder correct measurements.

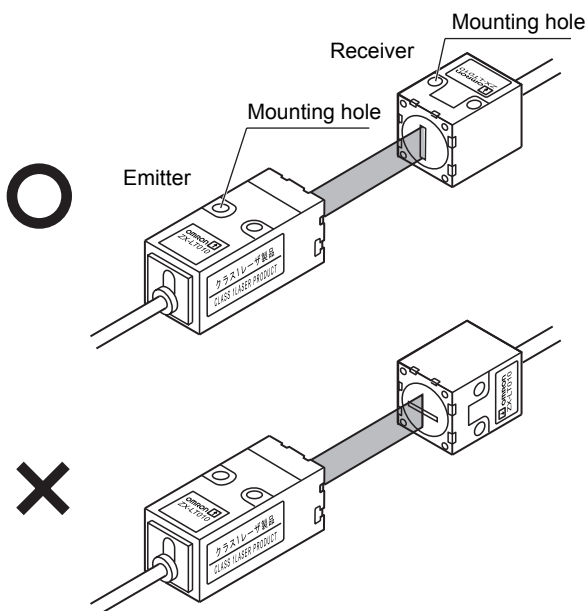

## ■ Adjusting the Optical Axis

Affix the optical axis adjustment seal (supplied with the sensor) on the front side of the receiver, and adjust the receiver position so that the laser beam is irradiated at the center of the cross on the seal.

For more accurate adjustment, adjust the receiver position so that the Amplifier Unit shows the largest reading.

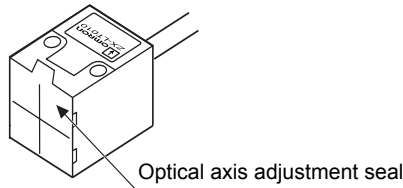

CHECK!

- When adjusting the receiver position, take care not to touch the emitter and receiver of the sensor head. Adhesion of finger marks may hinder correct measurements. If you have touched them, wipe them with a clean, soft cloth.
- The standard received light amount and scaling must be set after completion of optical axis adjustment.
- After optical axis adjustment is complete, remove the optical axis adjustment seal.



Setting the Standard Received Light Amount p.45, Scaling p.67

## ■ Installing the Side View Attachment

Fix the side view attachment with M2 screws (supplied with the product). The screws must be tightened with a torque of 0.08N•m or lower.

The side view attachment can be used even if only the emitter or receiver is mounted. Make sure that the emitter and receiver are mounted in the correct direction as shown below. Mounting them in the wrong direction will hinder correct measurements.

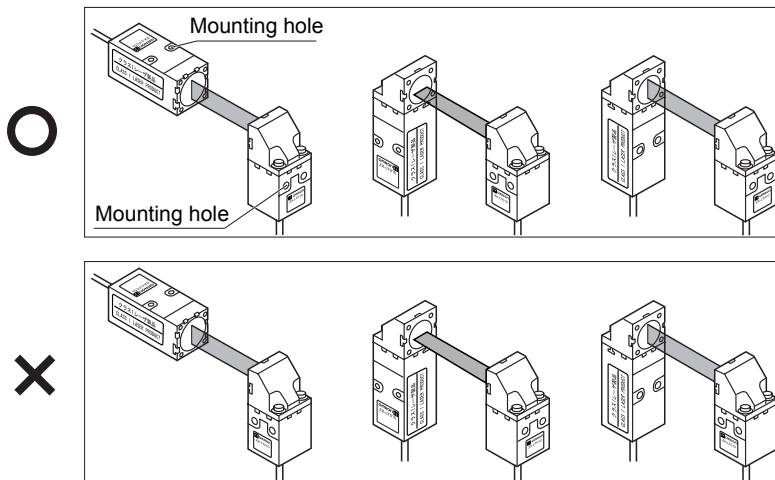

CHECK!

- Make sure that the screws are tightened with the same torque. Tightening them with different torque may cause the optical axis to shift.
- Tightening the screws with a torque exceeding 0.08N•m may damage the screw holes. Make sure that the screws are tightened with the specified torque.
- After the side view attachment is mounted, adjust the optical axis.

# Connections

This section describes how to connect component parts of the Smart Sensor.



Before connecting/disconnecting Smart Sensor components, make sure that the power to the Amplifier Unit is turned OFF. The Smart Sensor may malfunction if components are connected or removed while the power is ON.

## Sensor Head



Do not touch the terminals inside the connector.

### ■ Connecting the Reflective Type Sensor Head

Push the Sensor Head connector into the Amplifier Unit connector until it locks.

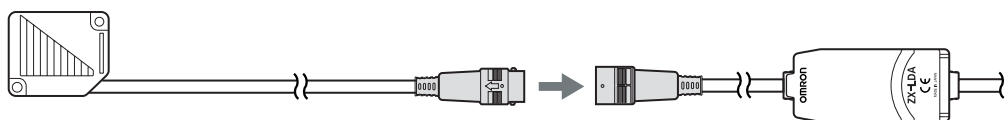

### ■ Connecting the Through-beam Type Sensor Head

1. Push the emitter and receiver connectors into the connectors (×2) of the Sensor Head - Amplifier Unit connecting cable until they lock.

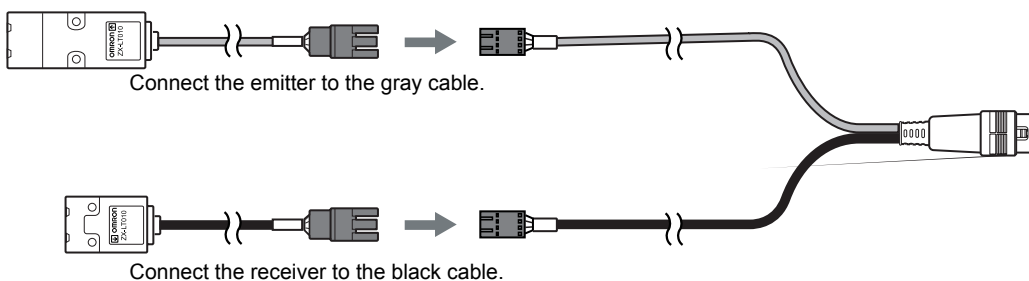

When connecting the Sensor Head, take care not to cause static electricity on the connectors.

2. Push the Sensor Head - Amplifier Unit cable connector into the Amplifier Unit connector until it locks.

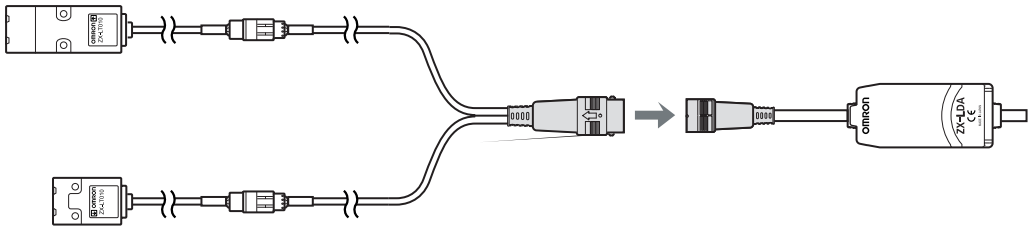

### ■ Disconnecting the Reflective Type Sensor Head

To disconnect the Reflective Type Sensor Head, hold the Sensor Head's connector ring and the Amplifier Unit connector, and then pull them straight out.



CHECK!

- Make sure to hold the connector of the Amplifier Unit to disconnect it. Failure to do so may damage the input cable of the Amplifier Unit.
- Do not touch the terminals inside the connector.

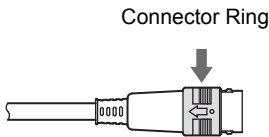

CHECK!

All settings on the Amplifier Unit will be cleared if the Sensor Head is replaced with a different type.

### ■ Disconnecting the Through-beam Type Sensor Head

1. Hold the connector ring of the Sensor Head – Amplifier Unit connecting cable and the Amplifier Unit connector, and then pull them straight out.



CHECK!

- Make sure to hold the connector of the Amplifier Unit to disconnect it. Failure to do so may damage the input cable of the Amplifier Unit.
- Do not touch the terminals inside the connector.

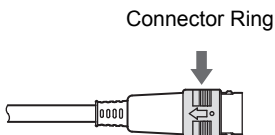

2. Unhook the connector of the Sensor Head – Amplifier Unit cable from the emitter and receiver connectors, and pull them straight out as shown below.

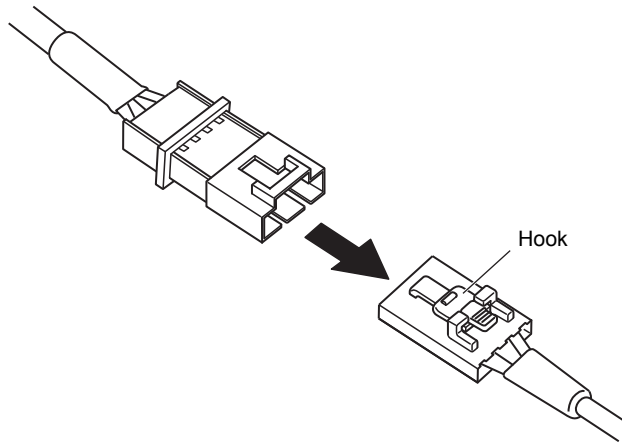



## Calculating Units

When you want to perform calculations between Amplifier Units, prevent mutual interference between Sensor Heads or connect ZX-SF11 to perform communication between Amplifier Units, use a Calculating Unit to connect the Amplifier Units.

The number of Amplifier Units that can be joined depends on the functions being used.

Functions	No. of Connectable Amplifier Units
Calculation	Max. 8
Mutual interference prevention	Max. 2
Communication (when ZX-SF11 is used)	Max. 5



Provide power to all connected Amplifier Units.

CHECK!

### ■ Connection Method

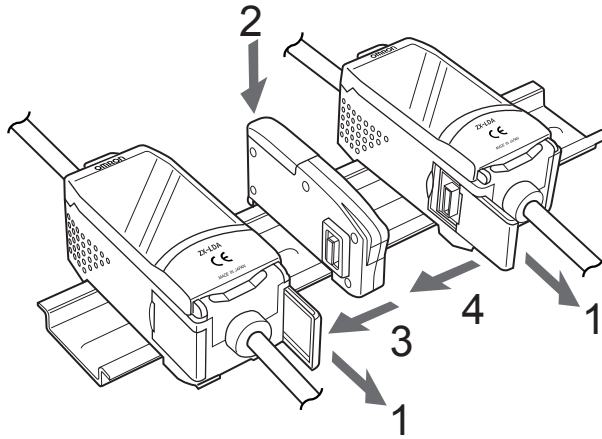

- 1.** Open the connector cover on the Amplifier Unit.  
Open the connector cover by lifting and sliding it open.
- 2.** Mount the Calculating Unit to the DIN Track.
- 3.** Slide and connect the Calculating Unit to the Amplifier Unit connector.
- 4.** Slide and connect the second Amplifier Unit to the Calculating Unit connector.

To disconnect the Interface Unit, perform the above operations in reverse order.

### ■ Channel Numbers of Amplifier Units

The following diagram shows the channel numbers when multiple Amplifier Units are connected.

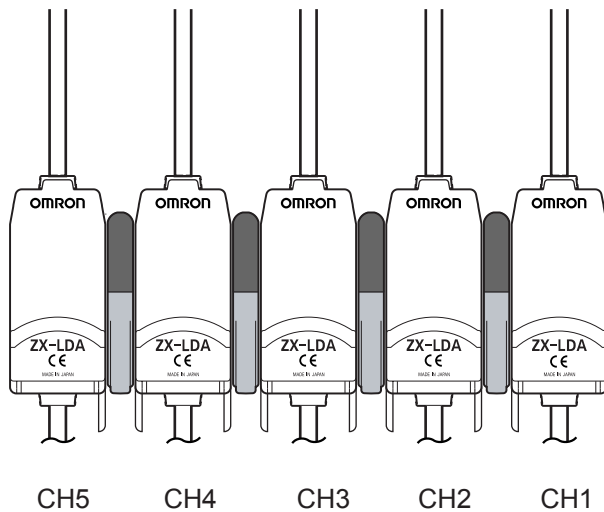

## Interface Units

Use an Interface Unit to connect a personal computer to the Smart Sensor system.

### ■ Connection Method

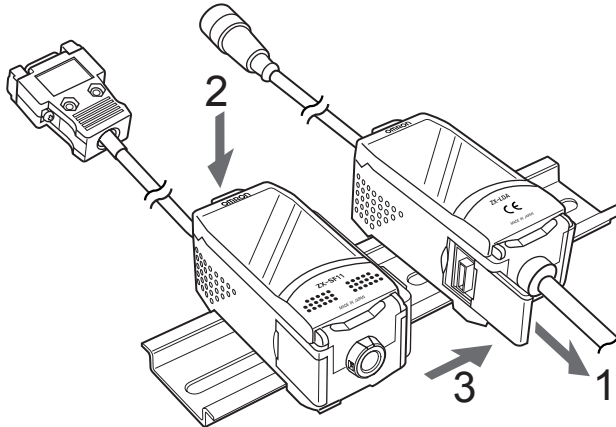

- 1.** Open the connector cover on the Amplifier Unit.  
Open the connector cover by lifting and sliding it open.
- 2.** Mount the Interface Unit to the DIN Track.
- 3.** Slide and connect the Interface Unit to the Amplifier Unit connector.

To disconnect the Interface Unit, perform the above operations in reverse order.



CHECK!

- When multiple Amplifier Units are used, connect the Interface Unit to the Amplifier Unit with the highest channel number.
- Communication with the Smart Monitor is possible via the Interface Unit.

 p.144

# Wiring Input/Output Cables

The input/output cable has the following wires.



Wire the cable correctly. Incorrect wiring may damage the Smart Sensor.

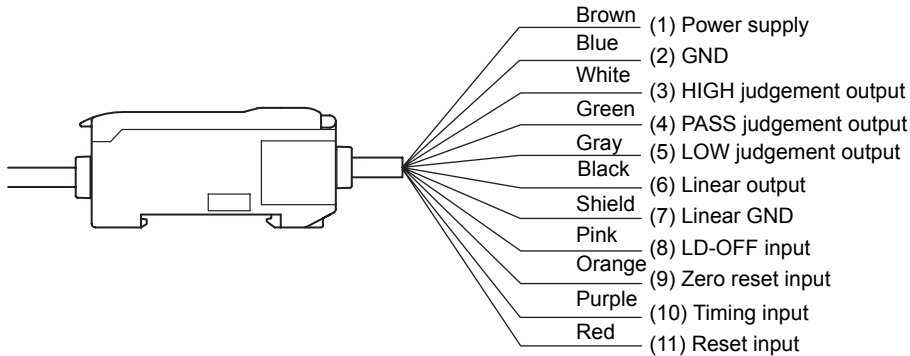

- (1) A 12- to 24-VDC ( $\pm 10\%$ ) power supply is connected to the power supply terminal. When using an Amplifier Unit with a PNP output, the power supply terminal is also the common I/O terminal for all I/O except for the linear output.



Use a stabilized power supply separate from other devices and power systems for the Amplifier Unit, particularly when high resolution is required.

- (2) The GND terminal is the 0-V power supply terminal. When using an Amplifier Unit with an NPN output, the GND terminal is also the common I/O terminal for all I/O except for the linear output.
- (3) The HIGH judgement output outputs judgement results (HIGH).
- (4) The PASS judgement output outputs judgement results (PASS).
- (5) The LOW judgement output outputs judgement results (LOW).
- (6) The linear output outputs a current or voltage in accordance with the measured value.
- (7) The linear output GND terminal is the 0-V terminal for the linear output.



- This ground wire must be grounded separately from the other ground wires.
- Always ground the linear output terminal even when linear output is not used.

- (8) If this LD-OFF signal is ON, the laser will stop emission, causing a light amount error. In this case, the linear output, digital display, judgement output and judgement output display signals will be output according to the non-measurement settings.

The sub-display will show [LDOFF].

- (9) The zero reset input is used to execute and clear zero reset.

p.118

- (10) The timing input is for signal input from external devices. Use it for hold function timing. The sub-display will show [TIMIG] while the hold function timing is input.
- (11) The reset input resets all measurement processing and outputs. The sub-display will show [RESET] while the hold function reset is input. The linear and judgement output signals will be output according to the non-measurement settings. If this reset input switches ON while the hold function is used, the state in effect before the hold function was set will be restored.

## I/O Circuit Diagrams

### ■ NPN Amplifier Unit

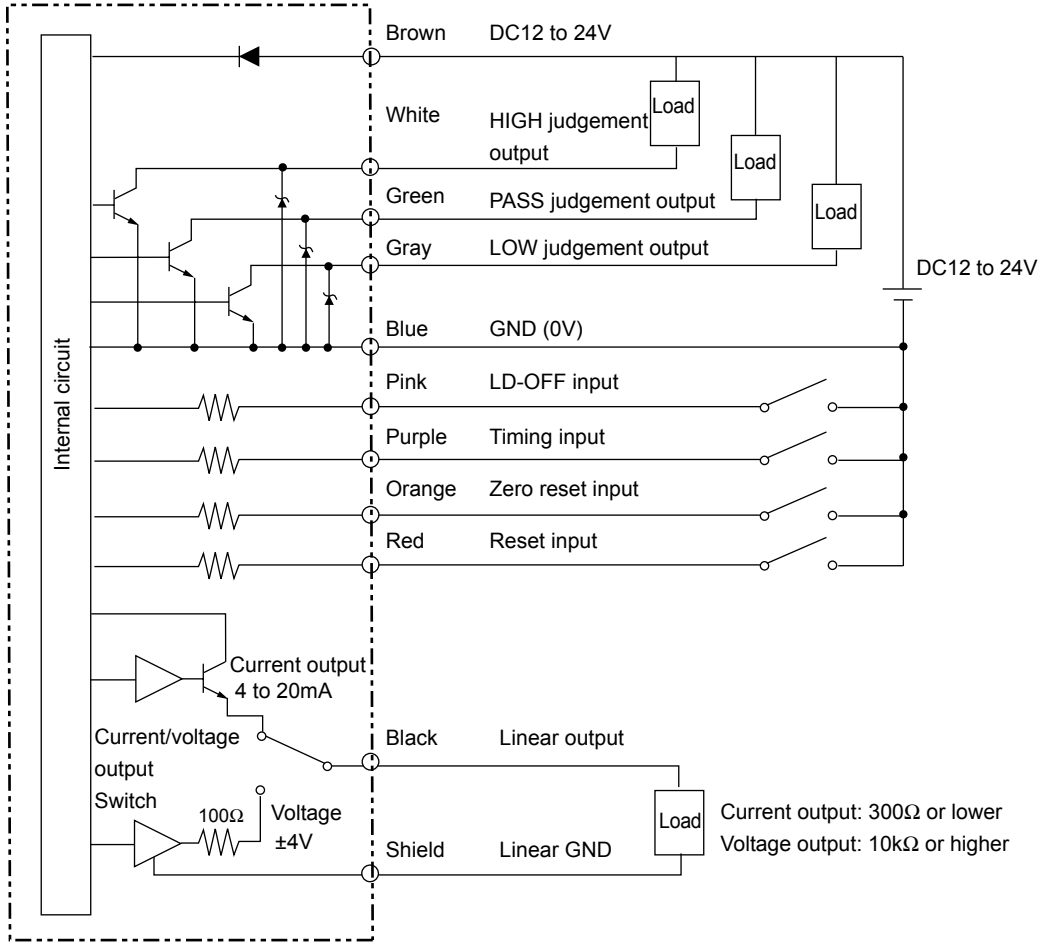

■ PNP Amplifier Unit

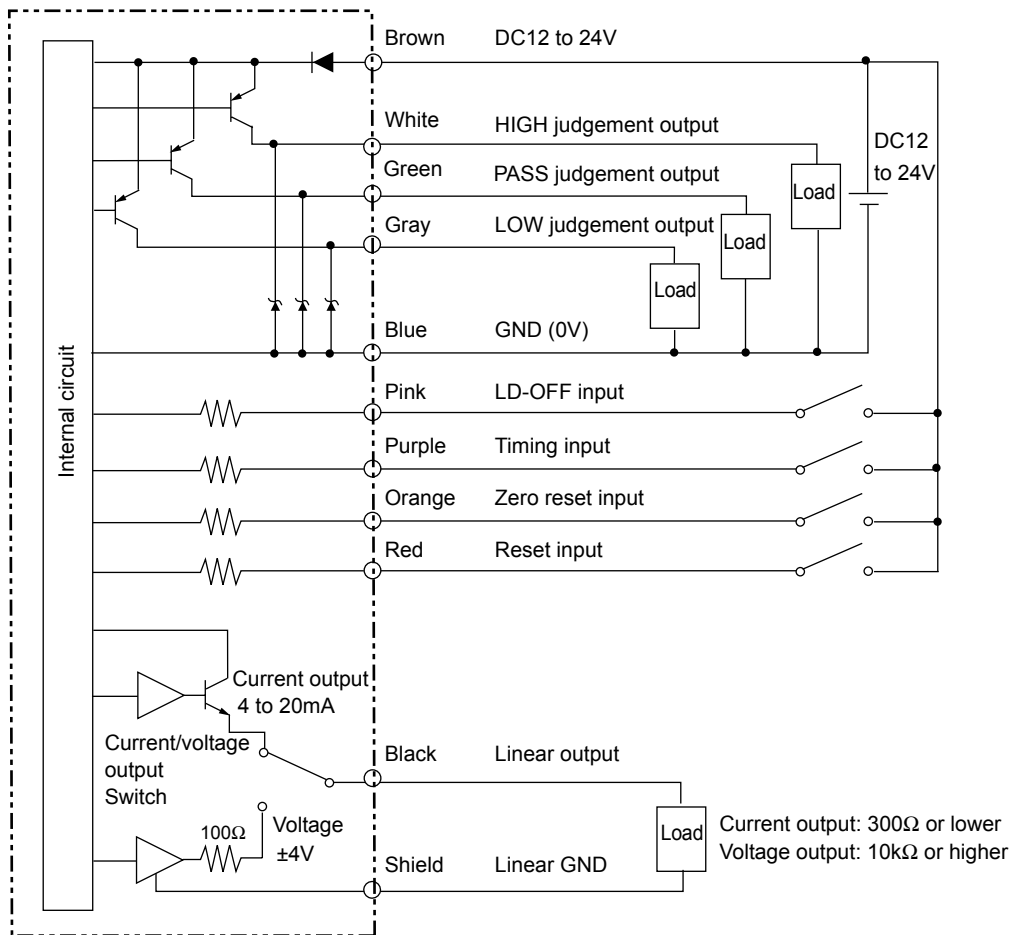

MEMO

# Section 3

## BASIC OPERATION

☒	Flow of Operation	32
☒	Basic Knowledge for Operation	34
	Switching Modes	34
	Reading Displays	35
	Key Operations	36
	Condition Settings	37
	Inputting Numeric Values	38
☒	Function Transition Charts	39
	RUN Mode	39
	T Mode	39
	FUN mode	40
☒	Setting the Auto Scale	42
☒	Setting the Standard Received Light Amount	45
☒	Measuring the Received Light Amount (Intensity Mode)	46



# Flow of Operation

When Reflective Type  
Sensor Head is  
Connected



Preparation for  
Measurement

Installation and Connection  
Preparation for  
Measurement p.9

Turn ON the power.

When Through-beam  
Type Sensor Head is  
Connected

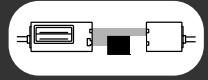

Preparation for  
Measurement

Installation and Connection  
Preparation for  
Measurement p.9

Turn ON the power.

Select the display unit (% or mm)  
and the item to be measured  
(received or blocked light  
amount).

Setting the Auto Scale p.42  
(Not necessary if the two-point  
scaling function is used)

Setting the Standard  
Received Light Amount  
p.45

Setting to Execution of Measurement Conditions

## Making Settings According to Your Application

- Measuring Height p.50
- Measuring Thickness p.54
- Measuring Eccentricity p.58  
and Vibration
- Measuring Edges p.61

## Setting/Changing Measurement Contents

- Setting Number of Samples to Average p.66
- Using Hold Functions p.76
- Comparing Measured Values  
(Differentiation Function) p.83
- Comparing Measured Values (Previous  
Value Comparisons) p.86
- Changing Display Scales p.67
- Setting the Measurement Sensitivity  
(Gain Switching) p.74

## Setting Judgement Conditions

- Entering Threshold Values p.88









## Setting Output Contents

- Linear Output p.95
- Setting Judgement Output Timing p.104





(If required)

## Correcting the Measurement Reference Point



- Using the Zero Reset Function p.116

<p><b>When a Problem Occurs....</b></p> <p> <b>The Smart Sensor Does Not Operate Correctly</b>   Troubleshooting p.126</p>	<p> <b>An Error Message Has Appeared</b>   Error Messages and Countermeasures p.127</p>
<p> <b>Want to Know Meanings of Terms</b>   Glossary p.130</p>	<p> <b>Want to Find Contents from Digital Displays</b>   Quick Reference for Displays p.152</p>

**Applied Use of Functions**

<p> <b>Measuring with Multiple Amplifier Units</b>          Performing Calculations p.108</p>
<p> <b>Saving Zero Reset Level (Zero Reset Memory)</b>          p.120</p>
<p> <b>(For Zero Reset) Entering Display Offset Values</b>          p.117</p>
<p> <b>Changing the Number of Display Digits</b>          p.112</p>
<p> <b>(For Reflective Type Sensor Head) Displaying the Received Light Amount on the Main Display</b>          Intensity Mode p.46</p>

**Additional Functions**

<p> <b>Using Power-Saving Mode</b>          p.115</p>
<p> <b>Reversing the Display</b>          p.113</p>
<p> <b>Key lock Function</b>          p.122</p>

**Changing/Deleting Settings**

<p> <b>Initializing Settings Data</b>          p.123</p>
---

# Basic Knowledge for Operation

## Switching Modes

The ZX-L has three modes. Use the Mode Switch on the Amplifier Unit to switch between modes.

Switch to the desired mode before starting operation.

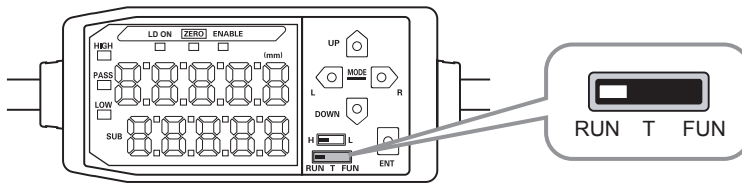

Mode	Description
RUN	Normal operation mode
T	Mode for setting the threshold values
FUN	Mode for setting measurement conditions

 Function Transition Charts p.39

## Reading Displays



The data displayed on the main and sub-displays depends on the mode currently selected. RUN mode has been selected prior to shipment from the factory.

When the power is turned ON, the type of amplifier unit and then the number of channels will be displayed on the main display.

The software version will be displayed on the sub-display.

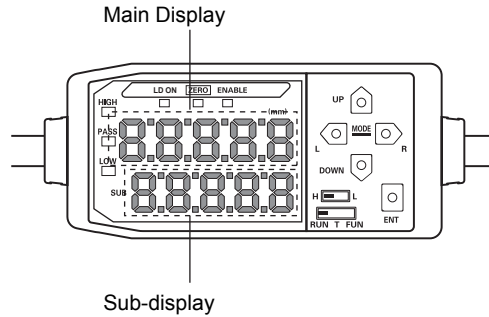
They are displayed for approx. three seconds, and then data for each mode will be displayed.



Mode	Main Display	Sub-display
RUN	Displays the measured value (the value after the measurement conditions have been reflected).  For example, when the hold function is set, the held value will be displayed.	Displays the threshold value, voltage, current, received light amount, resolution and present value in order when the Control Keys are pressed.  Threshold Value Display Displays either the HIGH or LOW threshold value, depending on the position of the threshold switch.  H  L
T	Displays the measured value (the value after the measurement conditions have been reflected).  For example, when the hold function is set, the held value will be displayed.	Displays the threshold value for the threshold being set. Displays either the HIGH or LOW threshold value, depending on the position of the threshold switch.  H  L
FUN	Displays the function names in order when the Control Keys are pressed.	Displays the setting for the function displayed on the main display.



Function Transition Charts p.39

## ■ Alphabet Display Format

The alphabet appears on the main and sub-displays as shown in the following table.

A	B	C	D	E	F	G	H	I	J	K	L	M
A	b	c	d	E	F	G	H	I	J	K	L	M
N	O	P	Q	R	S	T	U	V	W	X	Y	Z
n	o	P	q	r	S	t	U	v	Y	Z		

## Key Operations

Use the Control Keys to change the display and set measurement conditions.

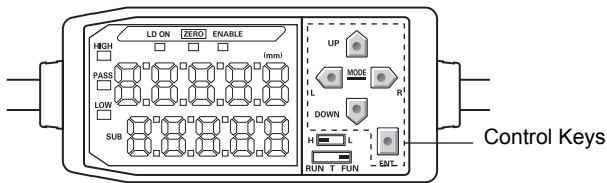

The mode currently selected determines the key functions.

Switching Modes p.34

Key		Function		
		RUN Mode	T Mode	FUN Mode
Cursor Keys	LEFT Key RIGHT Key	Changes sub-display content.	Used when selecting numeral digits.	Function changes depending on setting. <ul style="list-style-type: none"> <li>• Switches function display.</li> <li>• Selects numeral digit.</li> <li>• Stops setting.</li> </ul>
	UP Key DOWN Key	Performs timing input.  If the Sensor Head is the through-beam type, this cursor key is used to input reset signal. If the Sensor Head is the through-beam type, this cursor key is used to set the standard received light amount.	Used when changing numerals.	Function changes depending on setting. <ul style="list-style-type: none"> <li>• Switches between selections.</li> <li>• Changes numerals.</li> </ul>
	ENTL. Key	When held down for one second: Performs zero reset. When held down together with the Right Key for three seconds: Cancels zero reset.	Function changes depending on operation. <ul style="list-style-type: none"> <li>• Confirms threshold value.</li> <li>• Executes teaching.</li> </ul>	Confirms the set condition or value.

## Condition Settings

Display the target function on the main display and select the desired value from the sub-display to set measurement conditions.

This section uses the example of setting a peak hold as the hold condition to explain how to set measurement conditions.

### Moving to FUN mode and HOLD

1. Set the mode switch to FUN.



2. Use the LEFT and RIGHT Keys to display [HOLD] on the main display.



### Setting Hold Conditions

3. Press the UP or DOWN Key.  
The sub-display will flash.



4. Use the UP and DOWN Keys to select [P-H].



Press either the LEFT or RIGHT Key to cancel the selected option.



The display will return to the current setting (OFF in this example).

5. Press the ENT Key to confirm the setting.  
The setting will be registered.



## Inputting Numeric Values

This section describes how to input numeric values for threshold and output settings. The example of direct input of the low threshold value will be used.

Changing the low threshold from 40,000 to 39,000

Moving to T Mode

1. Set the mode switch to T.



Setting Threshold Values

2. Set the switch to L.

The measured value will be displayed on the main display.  
The current setting will be displayed on the sub-display.

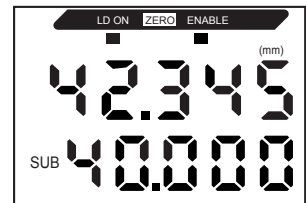

3. Press any Cursor Key.

The first digit on the sub-display will flash and direct input will be enabled.

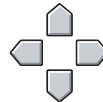

4. Use the UP and DOWN Keys to display 3.



5. Use the LEFT or RIGHT Key to move the cursor to the one's digit.



6. Use the UP and DOWN Keys to display 9.

To cancel the selected setting, use the LEFT Key to move the cursor to the leftmost digit and press the LEFT Key again. Alternatively, use the RIGHT Key to move to the rightmost digit and press the RIGHT Key again. The display will return to the current setting (40.000 in this example).



7. Press the ENT Key to confirm the setting.

The display will change from flashing to being lit continuously and the numeric value will be registered.



# Function Transition Charts

## Reading Transition Charts

The upper section is the main display and the lower section is the sub-display.

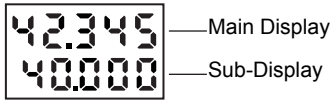

## RUN Mode

Measured value \*1 (The main display always shows the measured value.)

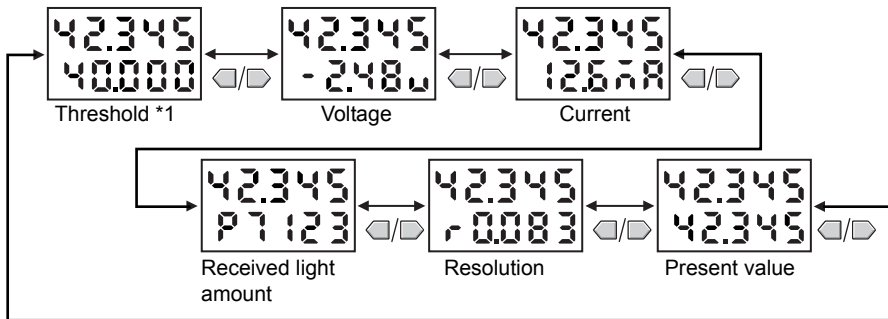

\*1 When the mode is switched to RUN, the measured and threshold values will be displayed first.

The numerals shown in the above diagram are an example only. The actual display may be different.

What is the present value? p.130

## T Mode

There is no function transition in T mode.

Measured value

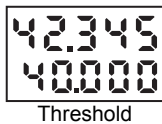

p.88

The numerals shown in the above diagram are an example only. The actual display may be different.

In RUN and T modes, the position of the threshold switch will determine whether the HIGH or LOW threshold will be displayed.

CHECK!

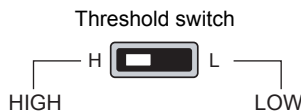



# FUN mode

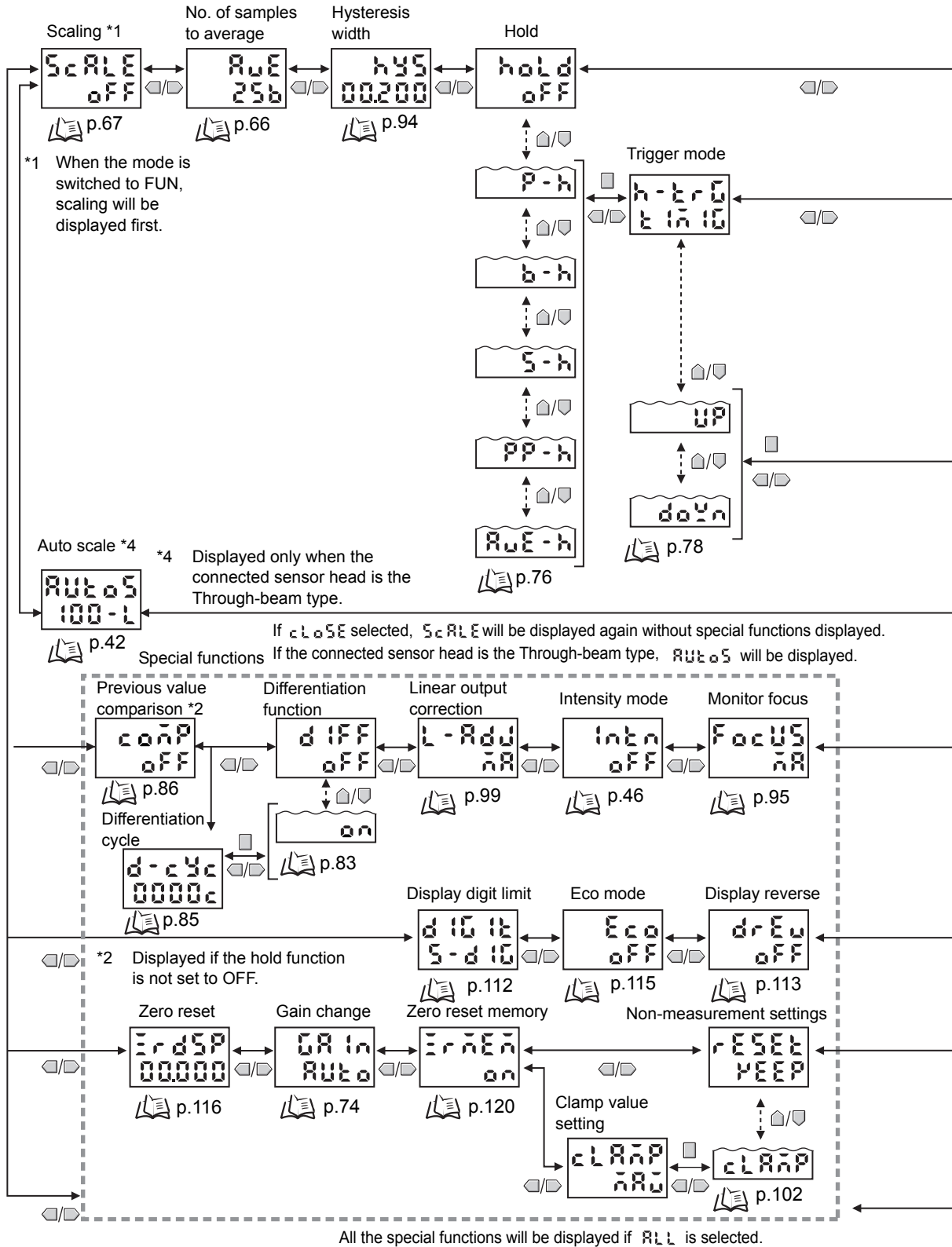

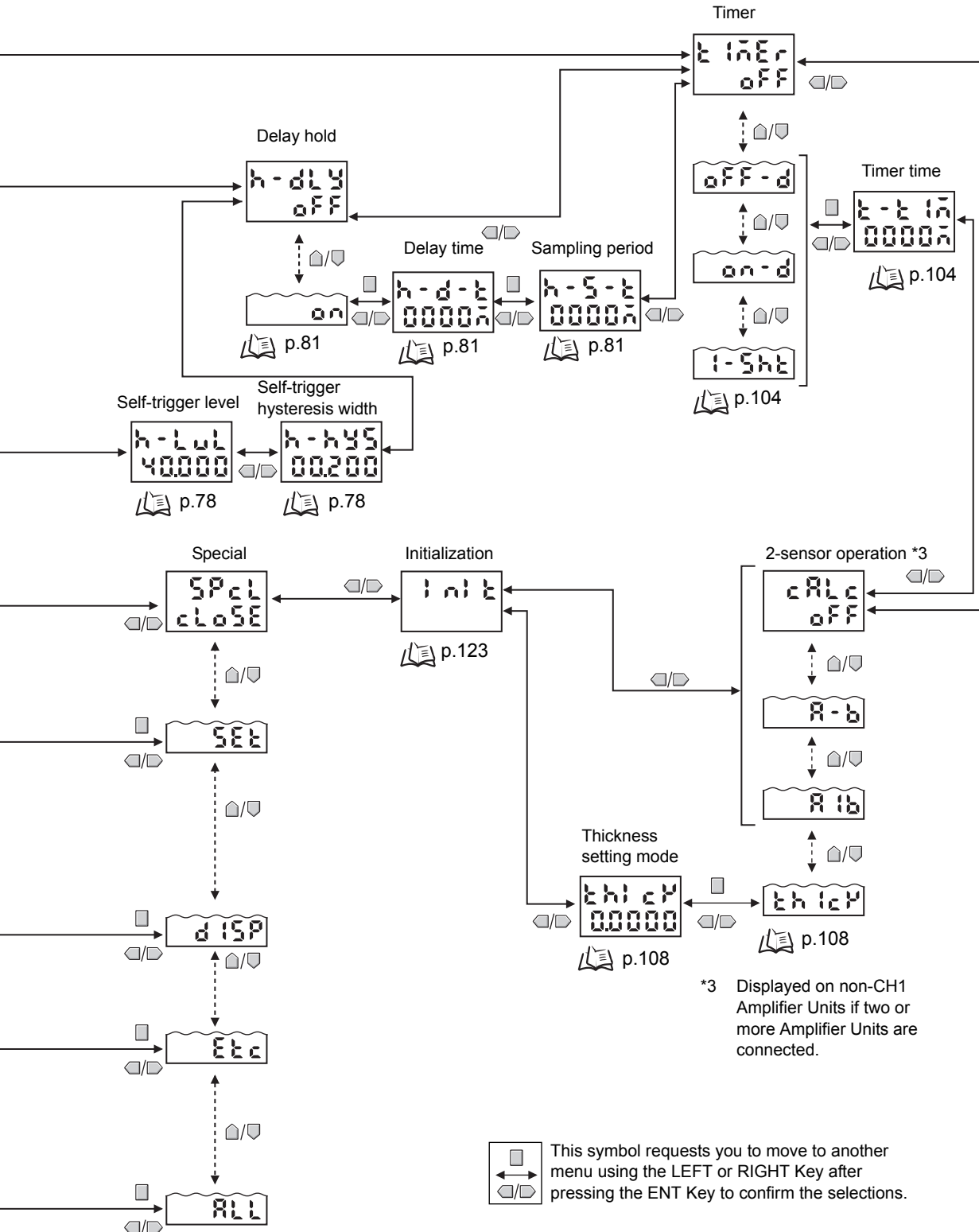

This symbol requests you to move to another menu using the LEFT or RIGHT Key after pressing the ENT Key to confirm the selections.

# Setting the Auto Scale

This setting is required only when the Sensor Head is the Through-beam type.

The auto scale function allows you to select whether the received light amount is to be displayed in mm or in % in the main display. It also allows you to select whether the received light amount or blocked light amount is to be displayed.

When the auto scale is set, the maximum received (blocked) light amount to be displayed will be automatically scaled, and then it is displayed and output.



If the two-point scaling function is used, auto scale setting is not necessary.



Two-point Scaling p.72

Selection Options		Remarks
100 - L		
L:	Displays and outputs the received light amount.	
d:	Displays and outputs the blocked light amount.	
5:	Sets the full scale to 5mm.	
10:	Sets the full scale to 10mm.	
30:	Sets the full scale to 30mm.	
100:	Sets the full scale to 100%.	
		-
		The full scale that is suitable for the sensor head's measuring width must be selected. Example: If ZX-LT005 is used, [5-L] or [5-d] must be selected.
		-

Display/Output Examples

Selection	Display Contents on Amplifier Unit	When light is 100% received	When light is 50% received	When light is 100% blocked	Remarks
5-L	Displays the received light amount in 0 to 5mm.	5.000	2.500	0.000	The linear output function is set so that the maximum output value is displayed for the maximum display value and the minimum output value for the minimum display value.
5-d	Displays the blocked light amount in 0 to 5mm.	0.000	2.500	5.000	
10-L	Displays the received light amount in 0 to 10mm.	10.000	5.000	0.000	
10-d	Displays the blocked light amount in 0 to 10mm.	0.000	5.000	10.000	
30-L	Displays the received light amount in 0 to 30mm.	30.000	15.000	0.000	
30-d	Displays the blocked light amount in 0 to 30mm.	0.000	15.000	30.000	
100-L	Displays the received light amount in 0 to 100%.	100.00	50.00	0.00	
100-d	Displays the blocked light amount in 0 to 100%.	0.00	50.00	100.00	

Example: Relationship between the received light amount and displayed value when auto scale is set to [5-L] or [5-d].

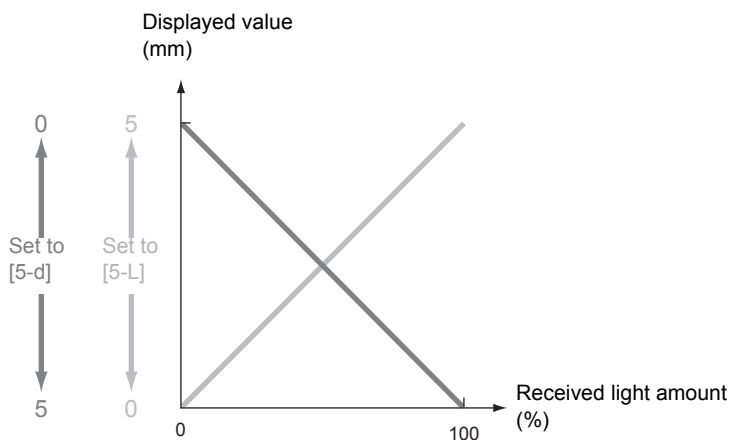

- The default setting at shipment is 100-L.
- If you want to display the received light amount in a width other than “0 to 5mm”, “0 to 10mm” and “0 to 30mm”, the two-point scaling function must be used.



Two-point Scaling p.72

- Auto scale must be set first. When auto scale is set, some settings (e.g. monitor focusing) are initialized.

## Section 3 BASIC OPERATION

### Moving to FUN Mode and AUTOS

1. Set the mode switch to FUN.



2. Use the LEFT and RIGHT Keys to display [AUTOS] on the main display.



### Setting the Auto Scale

3. Press the UP or DOWN Key.  
The sub-display will flash.



4. Select the desired auto scale.



5. Press the ENT Key to confirm the setting.  
The selected auto scale will be set.



# Setting the Standard Received Light Amount

This function can be used only when the Sensor Head is the Through-beam type.

The current received light amount can be set as the standard received light amount.

The standard received light amount must be set after installation of the sensor head and adjustment of optical axis. The amount of light input after the standard received light amount is set will be set to the full scale (F.S.).

Example: When 85% is displayed for the received light amount after completion of optical axis adjustment

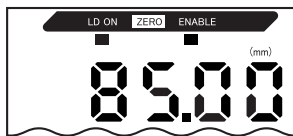
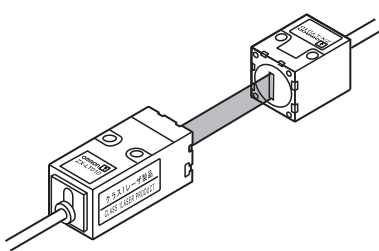

[85.00] is displayed in the main display with the Amplifier Unit set to RUN mode.

Set the standard received light amount.

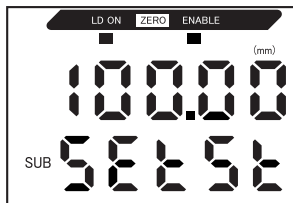

The current light input amount will be set to the full scale, and the main display shows [100.00]. When the standard received light amount is set, [SETST] is displayed in the sub-display.



CHECK!

- Setting of the standard received light amount must be carried out while zero reset is not in progress (i.e. while the zero reset indicator is not lit).
- When the standard received light amount is set, the main display and linear outputs (current, voltage) will be set to the full scale (F.S.) automatically.
- Setting of the standard received light amount can be done when the glass on the emitter/receiver gets dirty or when the received light amount has changed.
- If the mount position of the sensor head is changed, the standard received light amount must be set again.

## Moving to RUN Mode

1. Set the mode switch to RUN.



## Setting the Standard Received Light Amount

2. Hold down the DOWN Key for more than three seconds.



The standard received light amount that has been set will be stored in the memory of the Amplifier Unit.

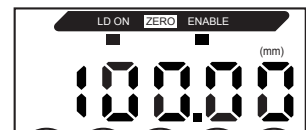

# Measuring the Received Light Amount (Intensity Mode)

This function can be used only when the sensor head is the Reflective type.

In the intensity mode, the received amount of light returning from the object can be displayed in the main display.

The intensity mode can be used when you want to detect changes in the color or material of the object. In the intensity mode, distance measurement is not possible.



- With the intensity mode, all processing, including 2-sensor operation, hold, threshold judgement and linear outputs, will be performed on the received light amount.
- To use intensity mode, intensity mode must be set first. When intensity mode is set, some settings (e.g. monitor focusing) are initialized.
- To use intensity mode, the measurement gain must be fixed to an option other than AUTO.



Setting the Measurement Sensitivity (Gain Switching) p.74

Moving to FUN Mode and SPCL

- 1.** Set the mode switch to FUN.



- 2.** Use the LEFT and RIGHT Keys to display [SPCL] on the main display.



Moving to INTN

- 3.** Press the UP or DOWN Key.  
The sub-display will flash.



- 4.** Use the UP and DOWN Keys to display [SET] or [ALL].



- 5.** Press the ENT Key.



- 6.** Use the LEFT and RIGHT Keys to display [INTN] on the main display.

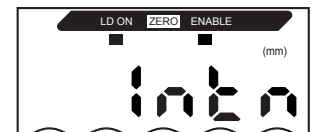

Switching to Intensity Mode

- 7.** Press the UP or DOWN Key.  
The sub-display will flash.



- 8.** Use the UP and DOWN Keys to display [ON].



- 9.** Press the ENT Key to confirm the setting.  
The Sensor Head will be set to intensity mode.





MEMO

# Section 4

## MAIN APPLICATIONS AND SETTING METHODS

☒ Measuring Height	50
☒ Measuring Thickness	54
☒ Measuring Eccentricity and Vibration	58
☒ Measuring Edges	61

# Measuring Height

This section describes how to measure the height of an object, using a PCB mold as an example.

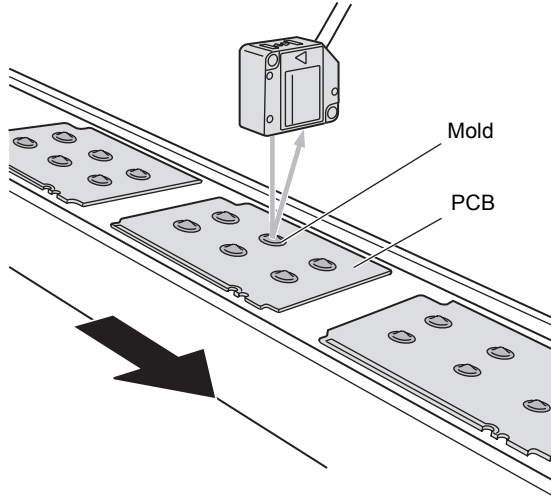

## ■Flow of Operation

Place an actual sensing object in position. Have a reference sample ready beforehand.



# 1 Mounting to Device

Mount the Sensor Head to the inspection device.

When mounting the sensor, take care not to exert pressure on the sensor head and wires.

 Installing Sensor Heads p.18

# 2 Adjusting Setting Position

Place the reference sample in position and adjust the Sensor Head position. Refer to the Amplifier Unit's display or Sensor Head's indicators, and adjust the Sensor Head position so that the upper and lower limits of the height (H) to be measured fall within the measuring range.

 Measuring range p.130

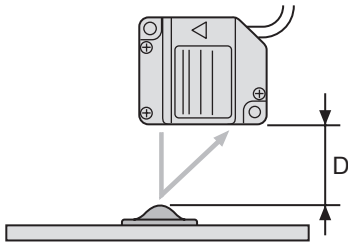

### Measured Value Display

The Amplifier Unit display shows the distance (D) from the reference sample.(Default)

The display can also be set to show the height (H) of the reference sample.

CHECK!

 Changing Display Scales p.67

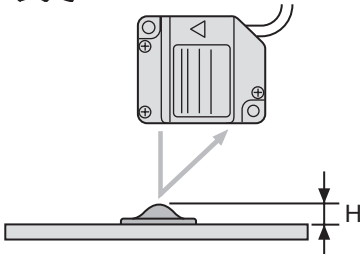

### 3 Setting Measurement Timing

Use the bottom hold function to hold the minimum value (bottom) during the sampling period.



When the timing signal cannot be input from the device, set a self-down trigger.

CHECK!

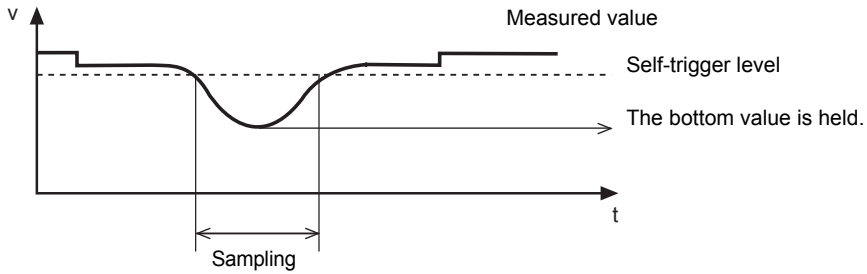

The following settings are required when the reference sample height is displayed using the scaling function:

Measurement trigger: Self-up trigger

Hold condition: Peak hold

CHECK!

Refer to Section 5 Detailed Settings for details on settings.



Using Hold Functions p.76

## 4 Measuring Reference Samples

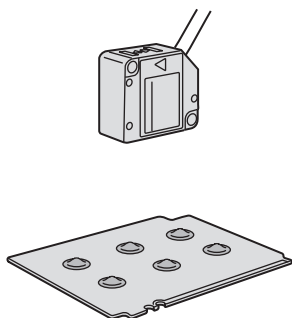

The height of the reference sample is measured using position teaching and the measurement result is registered as the HIGH threshold value.

The registered value becomes the reference for the threshold value set in step **5**.



Refer to Section 5 Detailed Settings for details on settings.

 Position Teaching p.90

 The reference sample height can also be set to 0.  
**CHECK!**  Using the Zero Reset Function p.116

## 5 Setting Tolerance Judgement Values

Refer to the HIGH threshold registered in step **4** and set the upper and lower limits (HIGH and LOW thresholds) for a PASS (OK) judgement.

The HIGH, PASS, and LOW judgement results will be output based on the threshold values set here.

Measurement Result	Judgement
Measurement result > HIGH threshold	HIGH
LOW threshold ≤ Measurement result ≤ HIGH threshold	PASS
LOW threshold > Measurement result	LOW

Refer to Section 5 Detailed Settings for details on operation.

 Inputting Threshold Values Directly p.89

# Measuring Thickness

This section describes how to measure thickness, using the thickness of a steel plate as an example.

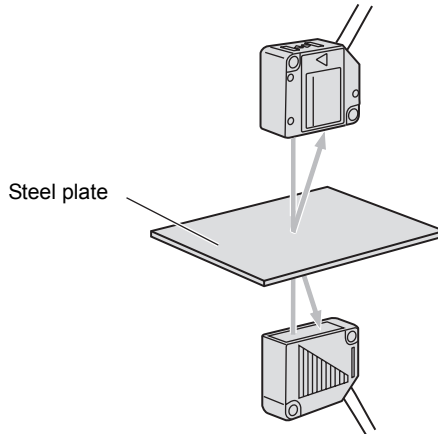

## ■Flow of Operation

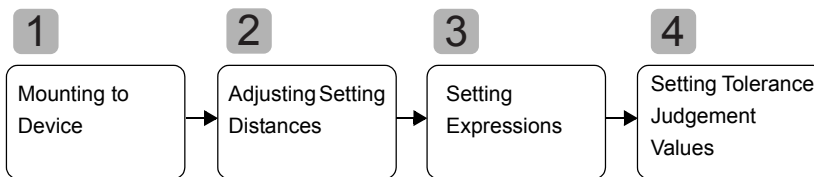

# 1 Mounting to Device

## ■ Connecting Amplifier Units

Connect two Amplifier Units by placing a Calculating Unit between them as shown in the diagram.

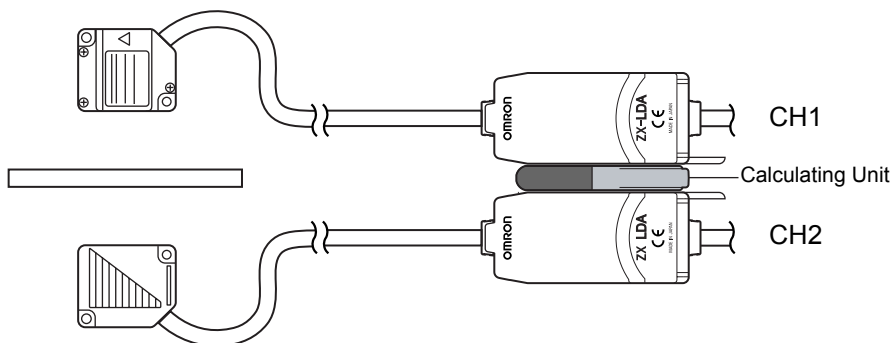

The calculation result is displayed on (i.e., output to) the CH2 Amplifier Unit. Connect the CH2 output cable to the external device to enable external control.

 Connections p.21

 The CH1 Amplifier Unit will display (output) the measurement result for the CH1 Sensor Head only.  
CHECK!

 If the Amplifier Units are connected, mutual interference between the Sensor Heads can also be prevented.  
CHECK!

## ■ Mounting Sensor Heads to Inspection Device

Mount the Sensor Heads to the steel plate in such a way that they face each other as shown below.

 Installing Sensor Heads p.18

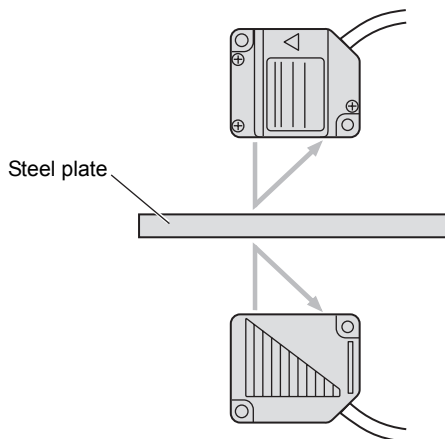



## 2 Adjusting Setting Distances

Set a reference sample with a known thickness (T).

Adjust the position of the Sensor Heads so that the distances (A, B) between the reference sample and the Sensor Heads are about the measuring center distance of the corresponding Sensor Head. Refer to the Amplifier Unit's display while adjusting the Sensor Head position.

 Measuring range p.130

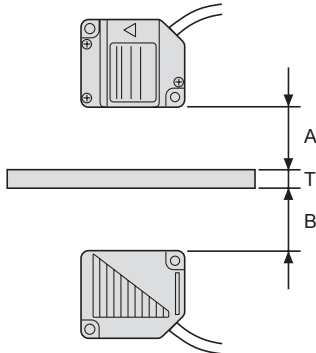

## 3 Setting Expressions

Position the reference sample and set the expression to calculate the thickness of the reference sample.

The settings are made on the CH2 Amplifier Unit.

Select [THICK] as the expression type and enter the thickness (T) of the reference sample.

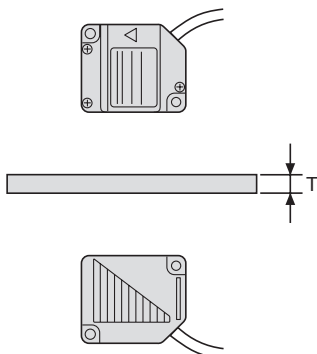

When the thickness is entered, the positional relationship between the Sensor Heads at that point will be registered. The thickness is measured based on the positional relationship of the Sensor Heads.

Refer to Section 6 Auxiliary Functions for details on settings.

 Performing Calculations p.108

## 4 Setting Tolerance Judgement Values

Set the upper and lower limits (HIGH and LOW thresholds) for the thickness for a PASS (OK) judgement.

The HIGH, PASS, and LOW judgement results will be output based on the threshold values set here.

Measurement Result	Judgement
Measurement result > HIGH threshold	HIGH
LOW threshold ≤ Measurement result ≤ HIGH threshold	PASS
LOW threshold > Measurement result	LOW

Refer to Section 5 Detailed Settings for details on operation.



Inputting Threshold Values Directly p.89

# Measuring Eccentricity and Vibration

This section describes, as an example, how to measure the eccentricity of a motor shaft.

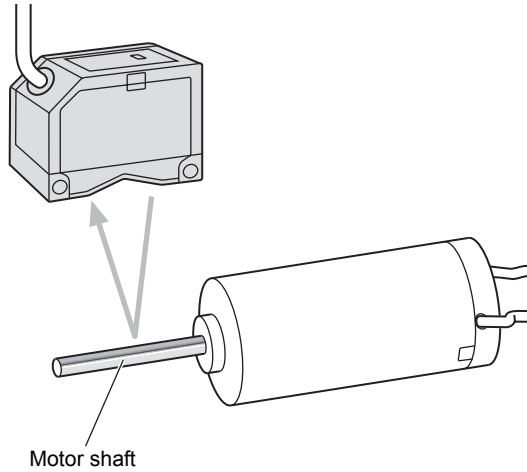

## Flow of Operation

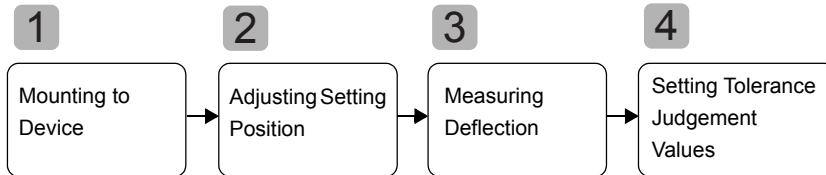

## 1 Mounting to Device

Mount the Sensor Head to the inspection device.

When mounting the sensor, take care not to exert pressure on the sensor head and wires.



Installing Sensor Heads p.18

## 2 Adjusting Setting Position

Adjust the position of the Sensor Head so that the distance (D) between the Sensor Head and the sensing object is about the measuring center distance, as shown in the diagram. Refer to the Amplifier Unit display while adjusting the Sensor Head position.



Measuring range p.130

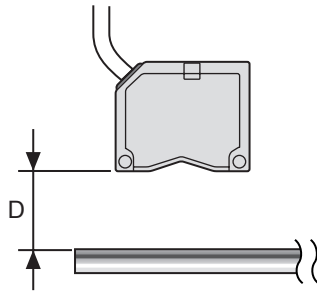

### 3 Measuring Deflection

Use the peak-to-peak hold function to measure the normal deflection.

Rotate the motor shaft, input a timing signal from an external device, and measure the deflection.

The difference between the maximum and minimum measurement results (the deflection) will be used as a reference when setting tolerances.

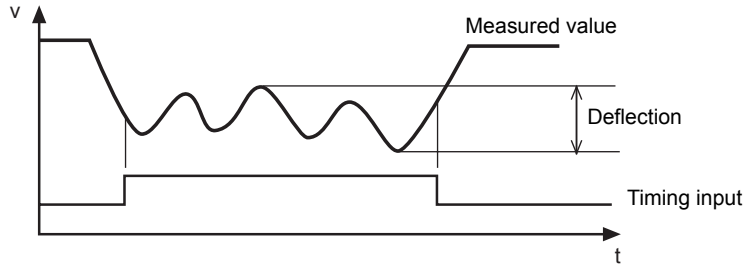

Refer to Section 5 Detailed Settings for details on settings.

 Using Hold Functions p.76

### 4 Setting Tolerance Judgement Values

Refer to the deflection measured in step **3** and set either the upper limit (HIGH threshold) or lower limit (LOW threshold) for a PASS (OK) judgement.

The judgement result will be output based on the threshold value set here. The output will depend on the type of threshold set.

Output when upper limit is set: PASS or HIGH

Output when lower limit is set: PASS or LOW

Measurement Result	Judgement
Measurement result > HIGH threshold	HIGH
LOW threshold ≤ Measurement result ≤ HIGH threshold	PASS
LOW threshold > Measurement result	LOW

Refer to Section 5 Detailed Settings for details on operation.

 Inputting Threshold Values Directly p.89

# Measuring Edges

This section describes, as an example, how to measure the edges of a rubber sheet.

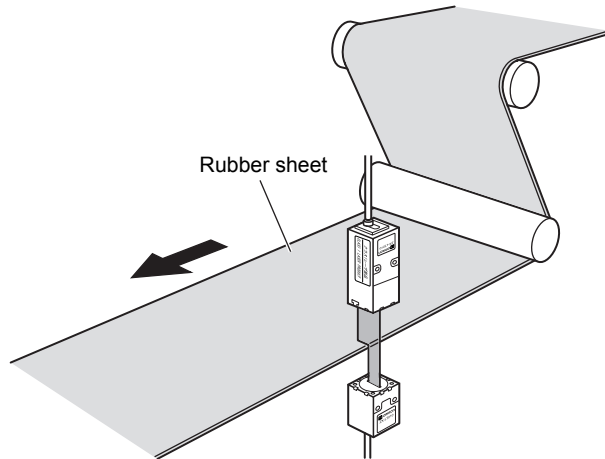

## ■Flow of Operation

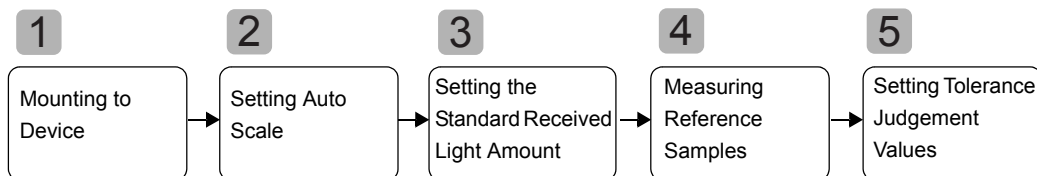

## 1 Mounting to Device

Mount the Sensor Head to the inspection device.

When mounting the sensor, take care not to exert pressure on the sensor head and wires.

 Installing Sensor Heads p.18

## 2 Setting Auto Scale

Decide whether to display the received light amount in mm or in % in the Amplifier Unit's main display.

 Setting the Auto Scale p.42

Example: To display 5mm as the current input light amount (85%)



Since 100% is equivalent to 5.000mm, [4.250] will be displayed in the case of 85%.

## 3 Setting the Standard Received Light Amount

With 100% laser input from the emitter to the receiver, set the standard received light amount.

When the standard received light amount is set, the main display and linear outputs (current, voltage) will be set to the full scale (F.S.) automatically.

 Setting the Standard Received Light Amount p.45

Example: Setting the standard received light amount after setting auto scale to

[5-L] in step **2**

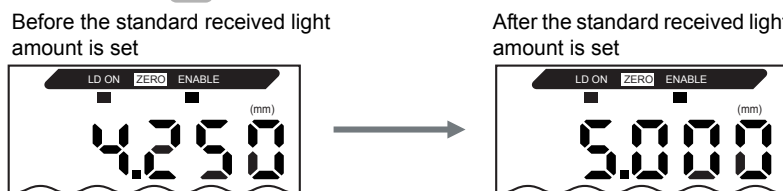

The current input light amount (85%) will be set to the full scale (F.S.) and [5.000] will be displayed.

## 4 Measuring Reference Samples

The edge of the reference sample is measured using position teaching and the measurement result is registered as the HIGH threshold value.

The registered value becomes the reference for the threshold value set in step **5**.

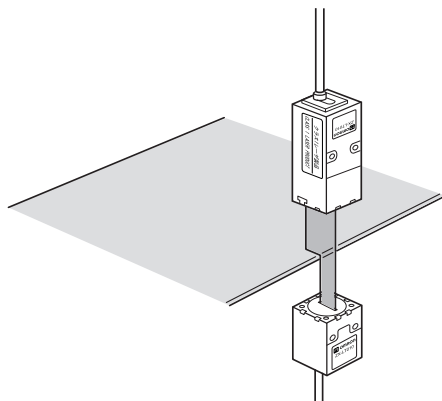

Refer to Section 5 Detailed Settings for details on settings.

 Position Teaching p.90

 The reference sample edge can also be set to 0.

**CHECK!**  Using the Zero Reset Function p.116

## 5 Setting Tolerance Judgement Values

Refer to the HIGH threshold registered in step **4** and set the upper and lower limits (HIGH and LOW thresholds) for a PASS (OK) judgement.

The HIGH, PASS, and LOW judgement results will be output based on the threshold values set here.

Measurement Result	Judgement
Measurement result > HIGH threshold	HIGH
LOW threshold ≤ Measurement result ≤ HIGH threshold	PASS
LOW threshold > Measurement result	LOW

Refer to Section 5 Detailed Settings for details on operation.

 Inputting Threshold Values Directly p.89



MEMO

# Section 5

## DETAILED SETTINGS

☒	Setting Number of Samples to Average	66
☒	Changing Display Scales	67
☒	Setting the Measurement Sensitivity (Gain Switching)	74
☒	Using Hold Functions	76
☒	Comparing Measured Values (Differentiation Function)	83
☒	Comparing Measured Values (Previous Value Comparisons)	86
☒	Entering Threshold Values	88
☒	Linear Output	95
☒	Setting Judgement Output Timing (Timer)	104

# Setting Number of Samples to Average

The average of the measured values obtained based on the preset number of samples can be output. This setting can be used when you want to ignore rapid changes in measured values. If this setting is made, response time for judgement and linear outputs will drop.

Selection for No. of samples to average	Response time
1	0.3 ms
2	0.5 ms
4	0.8 ms
8	1.5 ms
16	2.5 ms
32	5 ms
64	10 ms
128	20 ms
256	40 ms
512	75 ms
1024	150 ms
2048	300 ms
4096	600 ms

In the case of Reflective Type Sensor Head, the number of samples to average has been set to 256 prior to shipment from the factory.

In the case of Through-beam Type Sensor Head, the number of samples to average has been set to 32 prior to shipment from factory.



In general, when the number of samples to average is multiplied by "n", the resolution will increase by  $\sqrt{n}$ .

## Moving to FUN mode and AVE

1. Set the mode switch to FUN.



2. Use the LEFT and RIGHT Keys to display [AVE] on the main display.

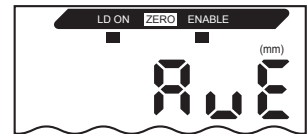

## Selecting Number of Samples to Average

3. Press the UP or DOWN Key.  
The sub-display will flash.



4. Use the UP and DOWN Keys to select the desired number of samples to average.



5. Press the ENT Key to confirm the setting.  
The setting will be registered.



# Changing Display Scales

Change the display scale when you want to display a value on the main display that is different from the actual measured value.

Place an actual sensing object in position.

Two setting methods are available: one-point and two-point scaling methods.



- The scaling set here is reflected in the display only.  
If you want to change the linear output of the displayed value, the monitor focus function must be used. The minimum display value is -19999, and the maximum display value is 59999. Values (scaling correction values) that exceed the minimum or maximum display value even if the object is located within the measuring range cannot be set. An error will occur if such a value is set.

p.95

- To calculate the thickness, refer to "Performing Calculations" in "Measuring with Multiple Amplifier Units".

p.108

## Scaling Application Example

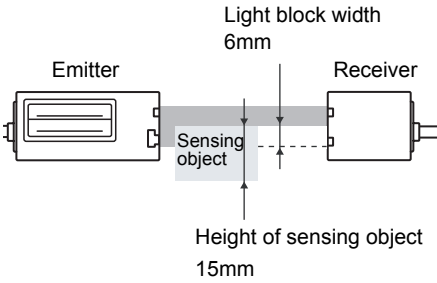
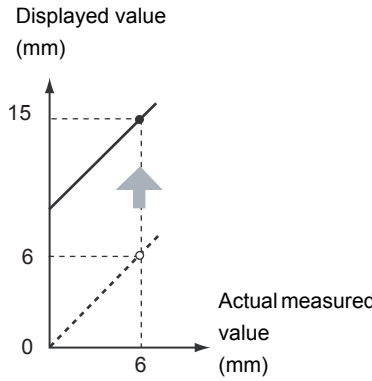
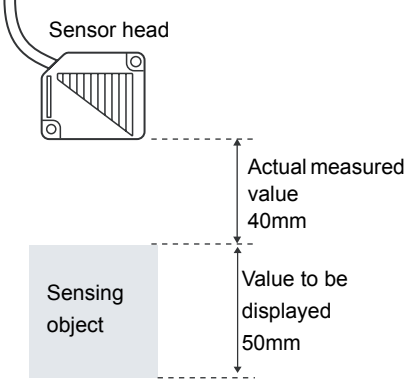
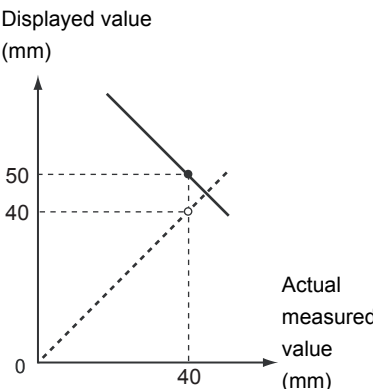
Purpose	Method	
<p>To display the height of the sensing object (Through-beam type sensor head)</p> 	<p>Offset the display value.</p> 	<p>One-point scaling (Not inverted.)</p> <p> p.69</p>
<p>To display the height of the sensing object (Reflective type sensor head)</p> 	<p>Offset the display value and invert the relationship between display and reference values.</p> 	<p>One-point scaling (Inverted)</p> <p> p.69</p>

**Scaling Application Example**

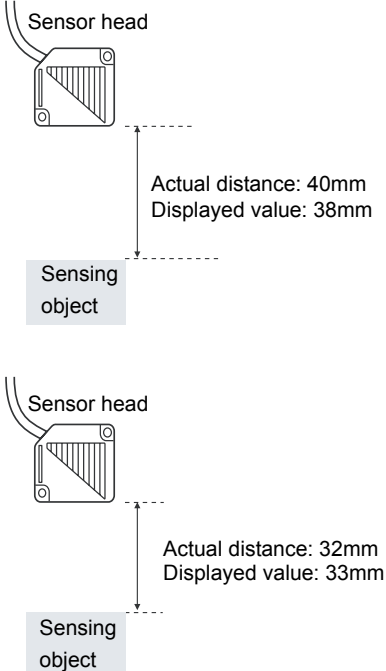
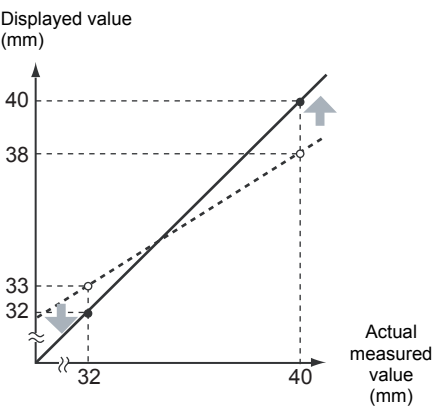
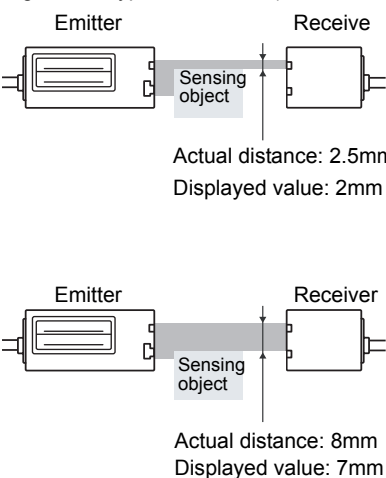
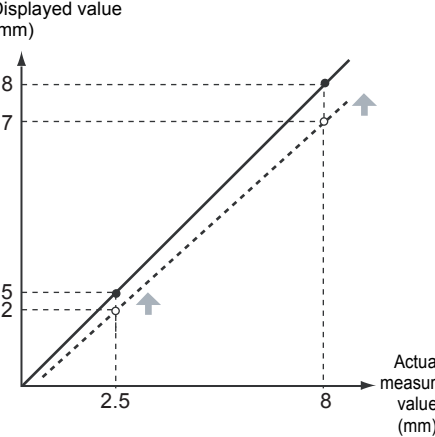
Purpose	Method	
<p>To correct display values to match actual distances (Reflective type sensor head)</p> 	<p>Offset the display value and change the display value range.</p> 	<p>Two-point scaling p.72</p>
<p>To correct display values to match actual distances (Through-beam type sensor head)</p> 		<p>Two-point scaling p.72</p>



The settings listed below return to the default settings when scaling is set.

Make the settings for these items after scaling settings have been completed.

CHECK!



Self-trigger level, p.78

Monitor focus p.95

Zero Reset, p.116

Thickness setting (calculation) p.108

# One-point Scaling

Measurement is performed at one position and offset values are set for that measurement.

The offset and increment/decrement inversion (display inversion) can be set.

This section describes how to set one-point scaling, using an example of correcting display values to match actual distances.

Example: Displaying the Height of the Sensing Object

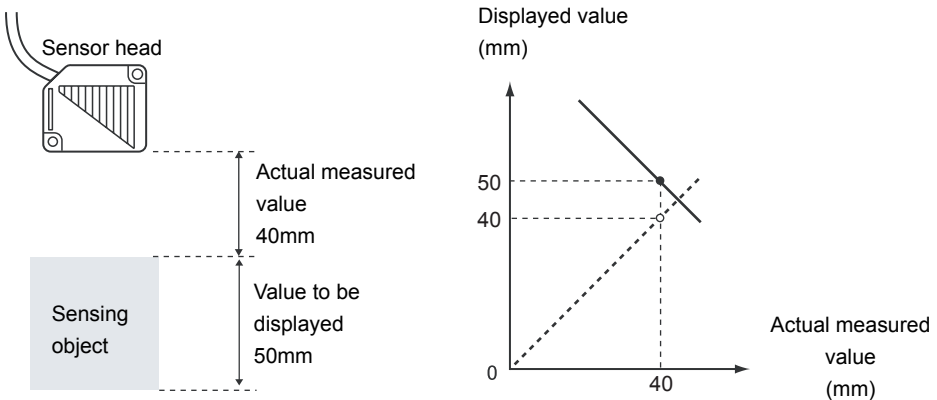

Moving to FUN Mode and SCALE

1. Set the mode switch to FUN.



2. Use the LEFT and RIGHT Keys to display [SCALE] on the main display.



Executing Scaling

3. Press the UP or DOWN Key.  
The sub-display will flash.



4. Use the UP and DOWN Keys to display [ON].



**Section 5**  
**DETAILED SETTINGS**

- 5.** Press the ENT Key to confirm the setting.  
The sub-display will show [P1SCL].

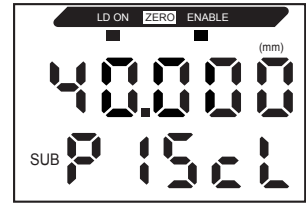

- 6.** Set the sensing object at the position where the display value change is required.



Set the sensing object within the measurement distance. The ENABLE indicator will be lit when the sensing object is within the measurement distance. Scaling is not possible if the sensing object is CHECK! not within the distance.

- 7.** Press any Cursor Key.  
The current measured value will be displayed on the main display.  
The leftmost digit of the sub-display will flash.

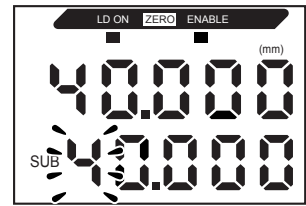
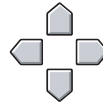

- 8.** Use the Cursor Keys to set the offset for the measured value in the sub-display.  
The position of the decimal point can be changed using the next steps.



--- Moves from one digit to another.



--- Changes the current value.

- 9.** Press the ENT Key to confirm the setting.  
The decimal point will flash.



- 10.** Use the LEFT and RIGHT Keys to change the position of the decimal point, if necessary.



- 11.** Press the ENT Key to confirm the setting.  
The inverted display settings will appear on the sub-display.

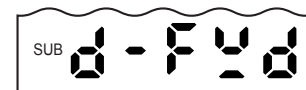

Selecting Inverted Display

**12.** Use the UP and DOWN Keys to select the inverted display function.



Selection	Details
D-FWD	Not inverted. The larger the distance between the Sensor Head and the object, the larger the measured value displayed on the Amplifier Unit.
D-INV	Inverted The larger the distance between the Sensor Head and the object, the smaller the measured value displayed on the Amplifier Unit.

**13.** Press the ENT Key to confirm the setting.  
The sub-display will be [P2SCL].



**14.** Press the ENT Key.



Confirming that Scaling Is Completed

If scaling has been completed correctly, the display will be [OK].

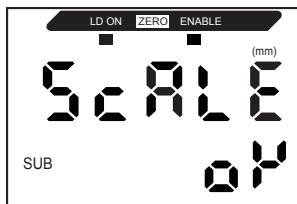

If scaling was unable to be completed, the display will be [NG].  
Check that the sensing object is within the measurement range and execute scaling again.

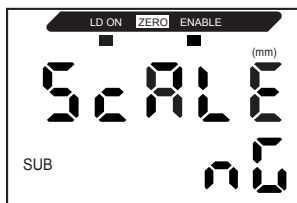



## Two-point Scaling

Measurement is performed at two positions and offset values are set for those measurements.

Both an overall offset can be set and the range can be changed.

This section describes how to set two-point scaling, using an example of correcting display values to match actual distances.

Example: Correcting Display Values to Match Actual Distances

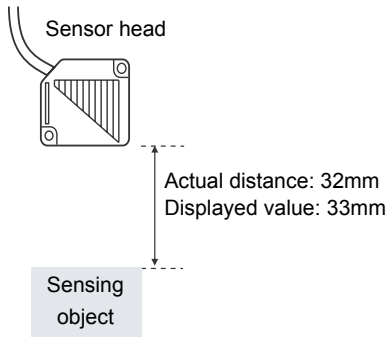
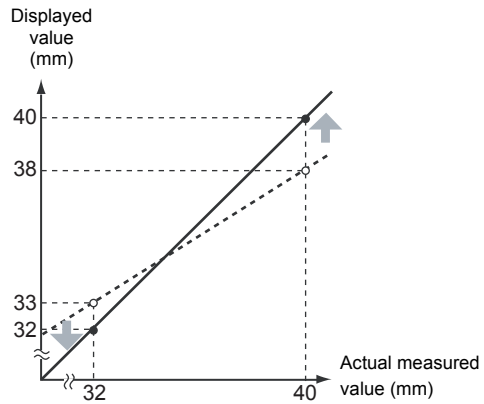
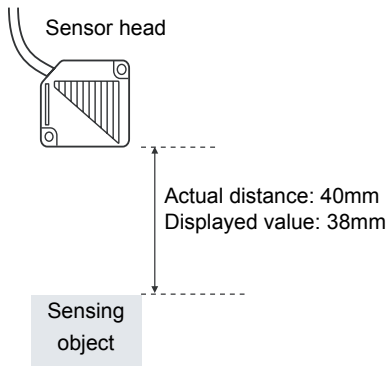

Separate the two specified points by at least 1% of the rated measurement range for the connected Sensor.

For example, the rated measurement range for the ZX-LD40 Sensor is 20 mm. Therefore, the two CHECK! specified points must be separated by 0.2 mm min.

### Setting the First Point

1. Set the first point by following steps 1. to 11. of the one-point scaling procedure.



p.69



CHECK!

The range for two-point scaling is automatically set based on the values entered for the two points. Inverted display settings are ignored.

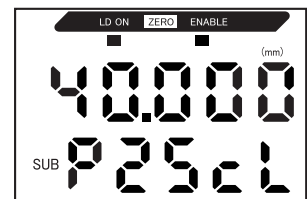

Setting the Second Point

- Place the sensing object in the position for which the display is to be changed (the second point).



CHECK!

The sensing object must be set at a distance at least 1% of the rated measurement range away from the first point and also at a distance within the measurement range.

- Press any Cursor Key.

The current measured value will be displayed on the main display.  
The leftmost digit of the sub-display will flash.

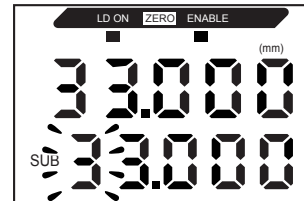
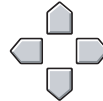

- Use the Cursor Keys to set the offset for the measured value.

The position of the decimal point can be changed using the next steps.



----- Moves from one digit to another.



----- Changes the current value.

- Press the ENT Key to confirm the setting.

The decimal point will flash.



- Use the LEFT and RIGHT Keys to move the decimal point.



- Press the ENT Key to confirm the setting.



Confirming the Completion of the Scaling Settings

If scaling has been completed correctly, the display will be [OK].



If scaling was unable to be completed, the display will be [NG].

Check the following points and then execute scaling again.

- Is the sensing object within the measurement range?
- Are the two points separated by at least 1% of the rated measurement range?



# Setting the Measurement Sensitivity (Gain Switching)

This section describes how to set the measurement gain according to the surface condition of the sensing object.

Setting the measurement gain to AUTO will automatically adjust the sensitivity to the optimum level for the object.

If the amount of reflective sensor light on the object does not change excessively, stable measurements can be carried out by fixing the measurement gain to an appropriate one.

Five measurement gains are available: [AUTO] for automatic adjustment, and [BLACK], [WHITE], [METAL] and [MIRROR], which are fixed measurement gains. In the case of fixed measurement gains, the measurement sensitivity increases in the order [MIRROR], [METAL], [WHITE], [BLACK], [MIRROR] with the lowest measurement sensitivity and [BLACK] with the highest measurement sensitivity.

## For [AUTO] measurement gain

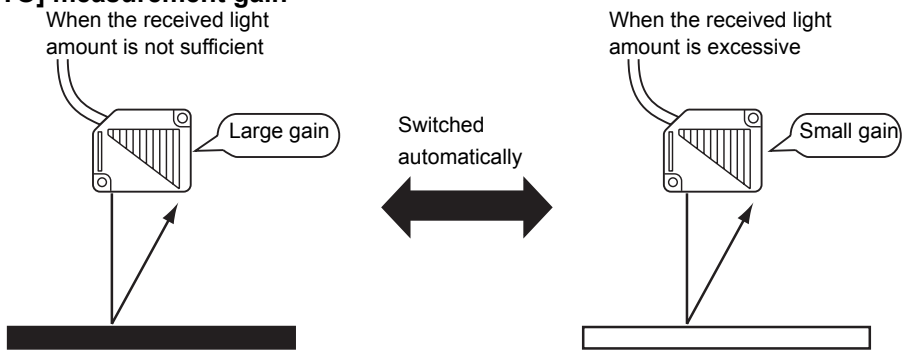

## For fixed measurement gains (other than [AUTO])

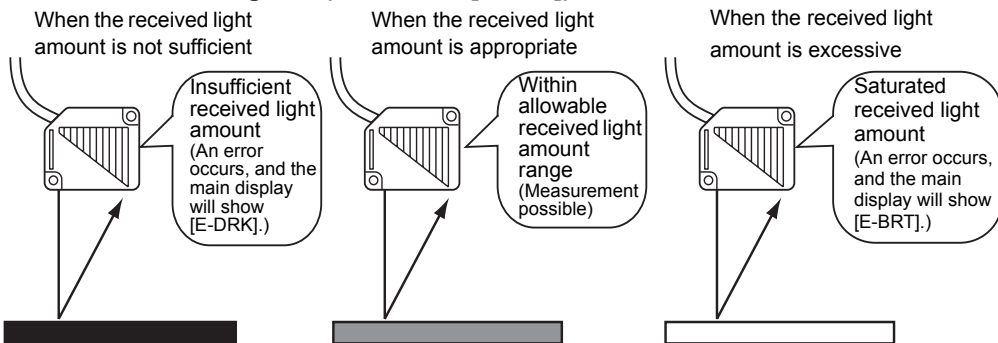

AUTO can be set only when the Sensor Head is the Reflective type and the intensity mode is disabled.

Intensity mode p.46

CHECK!

Moving to FUN Mode and SPCL

1. Set the mode switch to FUN.
2. Use the LEFT and RIGHT Keys to display [SPCL] on the main display.

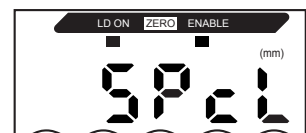
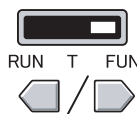

Moving to GAIN

- 3.** Press the UP or DOWN Key.  
The sub-display will flash.



- 4.** Use the UP and DOWN Keys to display [ETC] or [ALL].



- 5.** Press the ENT Key.



- 6.** Use the LEFT and RIGHT Keys to display [GAIN] on the main display.



Setting the Measurement Gain

- 7.** Press the UP or DOWN Key.  
The sub-display will flash.



- 8.** Select the desired measurement gain.



- 9.** Press the ENT Key to confirm the setting.  
The selected measurement gain will be set.



# Using Hold Functions

The hold functions hold data for specific points during the measurement period, such as the maximum or minimum value, and output those values at the end of the measurement period.

## Flow of Operation

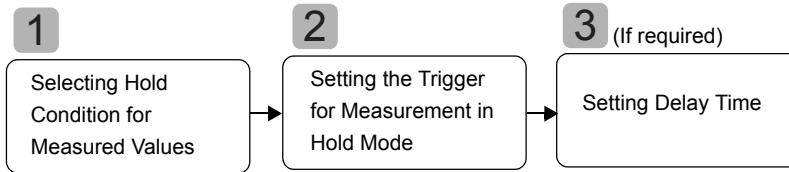

## 1 Selecting Hold Condition for Measured Values

The time period from the start of hold measurements to the end of hold measurements is called the sampling period.

The value to be held during that sampling period is selected here.



The CLAMP value is output until the first sampling period is finished.  
CLAMP value p.102

Any of the 5 settings shown in the table can be selected as the value to hold.

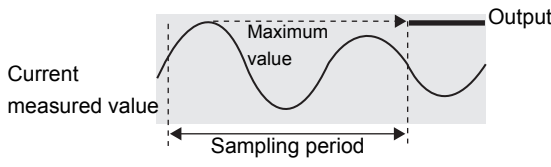
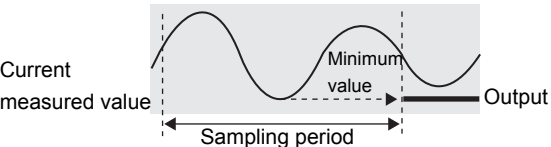
Selection	Details
OFF (Default)	Hold measurement is not performed. The measured value is always output.
P-H (Peak hold)	Holds the maximum value during the sampling period. The output changes at the end of the sampling period and is held until the end of the next sampling period.  
B-H (Bottom hold)	Holds the minimum value during the sampling period. The output changes at the end of the sampling period and is held until the end of the next sampling period.  

Selection	Details
PP-H (Peak-to-peak hold)	<p>Holds the difference between the maximum and minimum values. This option is selected mainly when detecting vibration. The output changes at the end of the sampling period and is held until the end of the next sampling period.</p>
S-H (Sample hold)	<p>Holds the measured value at the start of the sampling period. The output changes at the start of the sampling period and is held until the start of the next sampling period.</p>
AVE-H (Average hold)	<p>Holds the average measured value during the sampling period. The output changes at the end of the sampling period and is held until the end of the next sampling period.</p>

Moving to FUN mode and HOLD

1. Set the mode switch to FUN.



2. Use the LEFT and RIGHT Keys to display [HOLD] on the main display.

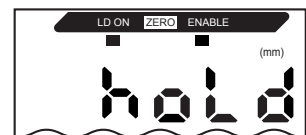

Selecting Hold Condition

3. Press the UP or DOWN Key.

The sub-display will flash.



4. Use the UP and DOWN Keys to select the desired hold condition.









5. Press the ENT Key to confirm the setting.

The setting will be registered.

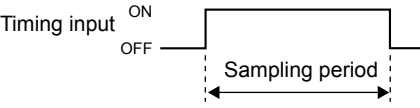

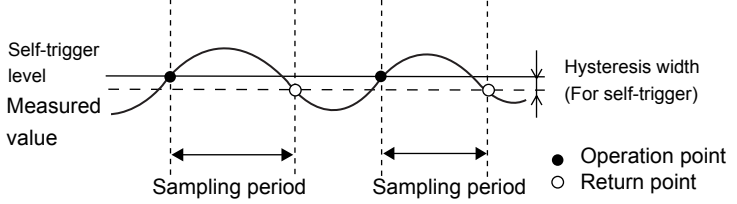
## 2 Setting the Trigger for Measurement in Hold Mode

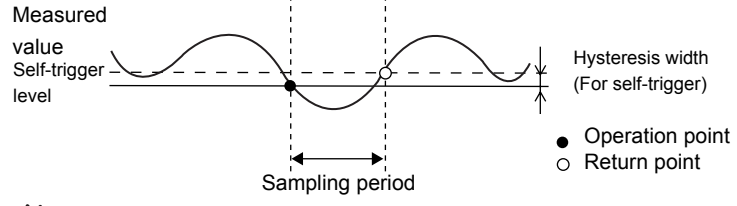
Select the input method for the timing of the start and end of the measurement period.

Selection	Details
<p>TIMIG (Timing input)</p> <p>(Default)</p>	<p>Enter the trigger for the start of sampling by using the timing input. The period that the timing signal is ON is the sampling period.</p>  <p>Timing input ON OFF</p> <p>Sampling period</p> <p> CHECK! When a delay time is set, the input OFF timing and the end of the sampling period will not be synchronous. Sampling will end after the specified sampling period has expired.</p>
<p>UP (Self-up trigger)</p>	<p>The sampling period is the period that the measured value is greater than the specified self-trigger level. Hold measurement is possible without a sync input.</p>  <p>Self-trigger level</p> <p>Measured value</p> <p>Sampling period</p> <p>Hysteresis width (For self-trigger)</p> <p>● Operation point ○ Return point</p> <p> CHECK! When a delay time is set, the timing when the measured value becomes smaller than the self-trigger level and the end of the sampling period will not be synchronous. Sampling will end after the specified sampling period has expired.</p>
<p>DOWN (Self-down trigger)</p>	<p>The sampling period is the period that the measured value is lower than the specified self-trigger level. Hold measurement is possible without a sync input.</p>  <p>Measured value</p> <p>Self-trigger level</p> <p>Sampling period</p> <p>Hysteresis width (For self-trigger)</p> <p>● Operation point ○ Return point</p> <p> CHECK! When a delay time is set, the timing when the measured value becomes greater than the self-trigger level and the end of the sampling period will not be synchronous. Sampling will end after the specified sampling period has expired.</p>



- Set the hysteresis width based on the fluctuations in the measured values around the trigger level. The hysteresis will be applied from the start of the sampling period and will prevent timing input chattering.
- Zero reset input will be invalid during sampling or while [----] is displayed in the main display.
- The timing input signal will be ignored if the self-trigger level is set to [UP] or [DOWN]. However, sampling will not be affected.

Selecting Trigger Types

1. Use the LEFT and RIGHT Keys to display [H-TRG] on the main display.  
[H-TRG] will not be displayed if the delay conditions are set to OFF.



2. Press the UP or DOWN Key.  
The sub-display will flash.



3. Use the UP or DOWN Key to select the desired trigger type.



4. Press the ENT Key to confirm the setting.  
The selected trigger type will be registered.



Setting Trigger Levels (when UP or DOWN Is Selected)

5. Use the RIGHT or LEFT Key to display [H-LVL] on the main display.  
[H-LVL] will not be displayed if timing input [TIMIG] is set as the trigger.



6. Press the UP or DOWN Key.  
The leftmost digit of the sub-display will flash.



7. Use the Cursor Keys to set the desired trigger level.



---- Moves from one digit to another.



---- Changes the current value.

8. Press the ENT Key to confirm the setting.  
The trigger level will be registered.





Setting Hysteresis Width (when UP or DOWN Is Selected)

- 9.** Use the LEFT and RIGHT Keys to display [H-HYS] on the main display.

[H-HYS] will not be displayed if timing input [TIMIG] is set as the trigger.

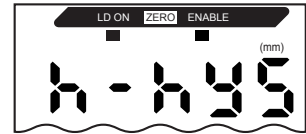

- 10.** Press the UP or DOWN Key.

The leftmost digit of the sub-display will flash.



- 11.** Use the Cursor Keys to set the hysteresis width for the trigger level.



----- Moves from one digit to another.



----- Changes the current value.

- 12.** Press the ENT Key to confirm the setting.

The hysteresis width will be registered.



### 3 Setting Delay Time

Delay time is set to ignore measurements immediately after the timing input. This is useful for avoiding bounding during device startup and the influence of machine vibration.

The delay time (the delay between timing input and the start of sampling) and the sampling period can be set.

The default delay time setting is [OFF].



Make the sum of the delay time and sampling period less than the timing input ON interval. If the next timing input for measurement is received before the delay and sampling period have passed, that timing input will be ignored and will not be reflected in the sampling.

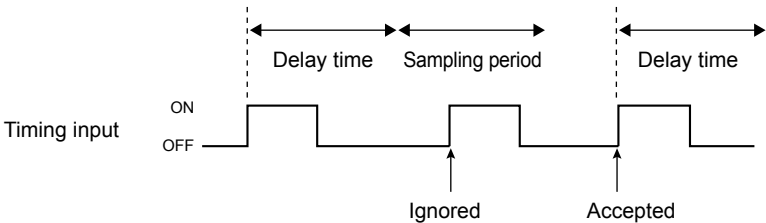

Moving to Delay Hold (H-DLY)

1. Use the LEFT and RIGHT Keys to display [H-DLY] on the main display.  
[H-DLY] will not be displayed if the delay conditions are set to [OFF].



2. Press the UP or DOWN Key.  
The sub-display will flash.



3. Use the UP and DOWN Keys to display [ON].



4. Press the ENT Key.  
The settings mode for the H-DLY function is now enabled.



Setting Delay Time

- 5.** Use the LEFT and RIGHT Keys to display [H-D-T] on the main display.

[H-D-T] will not be displayed if the H-DLY function is set to [OFF].

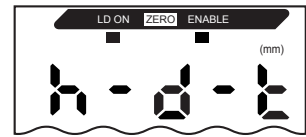

- 6.** Press the UP or DOWN Key.

The leftmost digit of the sub-display will flash.



- 7.** Enter the delay time (ms).



---- Moves from one digit to another.



---- Changes the current value.

- 8.** Press the ENT Key to confirm the setting.

The delay time will be registered.



Setting the Sampling Period

- 9.** Use the LEFT and RIGHT Keys to display [H-S-T] on the main display.

[H-S-T] will not be displayed if the H-DLY function is set to [OFF].

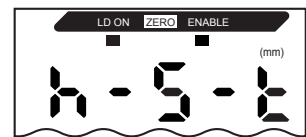

- 10.** Press the UP or DOWN Key.

The leftmost digit of the sub-display will flash.



- 11.** Use the Cursor Keys to enter the sampling period (ms).



---- Moves from one digit to another.



---- Changes the current value.

- 12.** Press the ENT Key to confirm the setting.

The sampling period will be registered.



# Comparing Measured Values (Differentiation Function)

Use the differentiation function to detect only sudden changes in the measured values that occur during very short periods of time.

The differentiation function detects changes between the present value and the measured value that is in effect just before the comparing pitch. The coefficient of this comparing pitch is defined as the differentiation cycle.

The relationship between the differentiation cycle and comparing pitch can be calculated by the following equation.

$$\text{Comparing pitch} = \text{Differentiation cycle} \times 150\mu\text{s}$$

Example: When differentiation cycle = 10

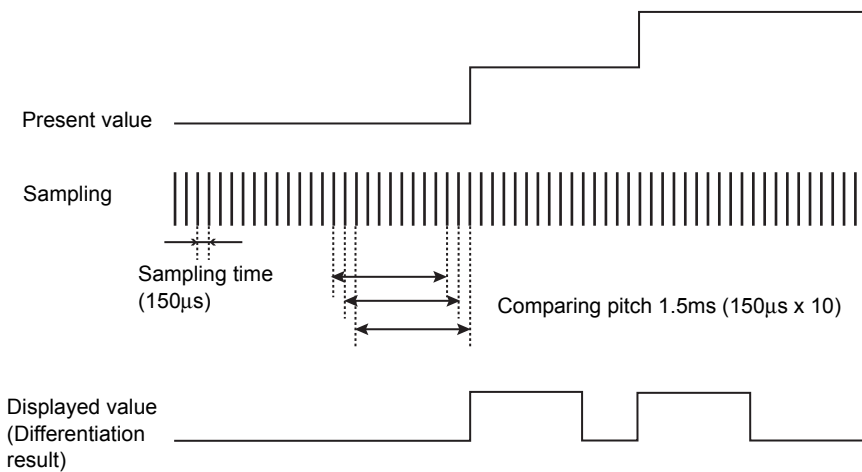

If you want to detect changes in hold value, use the previous value comparison function.   
Previous value comparison p.86

## Moving to FUN Mode and SPCL

1. Set the mode switch to FUN.



2. Use the LEFT and RIGHT Keys to display [SPCL] on the main display.



Moving to DIFF

- 3.** Press the UP or DOWN Key.  
The sub-display will flash.



- 4.** Use the UP and DOWN Keys to display [SET] or [ALL].



- 5.** Press the ENT Key.



- 6.** Use the LEFT and RIGHT Keys to display [DIFF] on the main display.

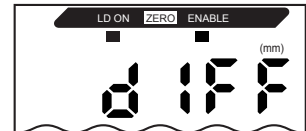

Moving to Differentiation Cycle

- 7.** Press the UP or DOWN Key.  
The sub-display will flash.



- 8.** Use the UP and DOWN Keys to display [ON].



- 9.** Press the ENT Key.  
Settings for differentiation cycle can now be made.



Setting the Differentiation Cycle

- 10.** Use the LEFT and RIGHT Keys to display [D-CYC] on the main display.  
[D-CYC] will not be displayed if the DIFF is set to OFF.



- 11.** Press the UP or DOWN Key.  
The leftmost digit of the sub-display will flash.



- 12.** Use the Cursor Keys to set the differentiation cycle.



----- Moves from one digit to another.



----- Changes the current value.

- 13.** Press the ENT Key to confirm the setting.  
The setting will be registered.



# Comparing Measured Values (Previous Value Comparisons)

Use the previous value comparison function to ignore gradual changes in measured values over time, due to factors such as temperature drift, and only detect and judge sudden changes.

The hold function must be set before previous value comparison can be set. The difference from the previous hold value with a PASS judgement becomes the measured value.

For example, if the judgement for that previous measurement is HIGH or LOW, the comparison is performed with the hold value before that.

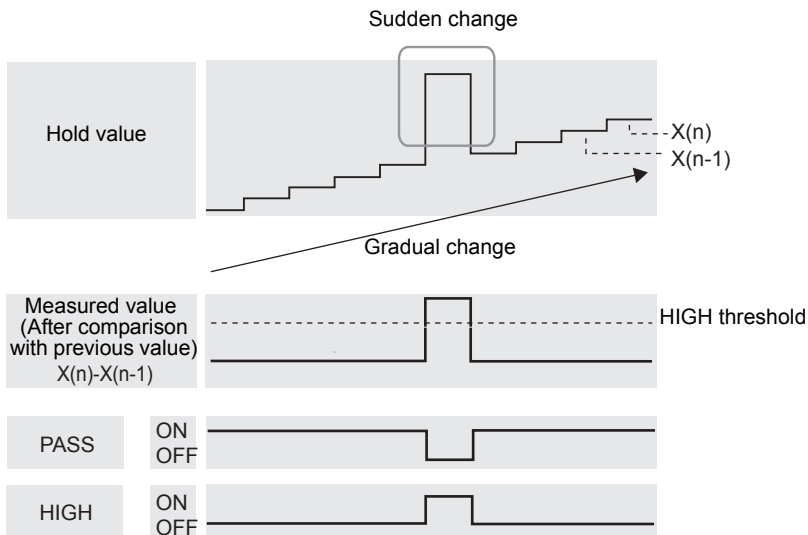

The hysteresis width setting will be disabled if the previous value comparison function is used.

Hysteresis Setting p.94

Moving to FUN Mode and SPCL

1. Set the mode switch to FUN.
2. Use the LEFT and RIGHT Keys to display [SPCL] on the main display.

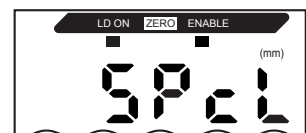
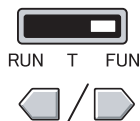

Moving to COMP

- 3.** Press the UP or DOWN Key.  
The sub-display will flash.



- 4.** Use the UP and DOWN Keys to display [SET] or [ALL].



- 5.** Press the ENT Key.



- 6.** Use the LEFT and RIGHT Keys to display [COMP] on the main display.



Setting Previous Value Comparison

- 7.** Press the UP or DOWN Key.  
The sub-display will flash.



- 8.** Use the UP and DOWN Keys to display [ON].



- 9.** Press the ENT Key to confirm the setting.  
The previous value comparison function can now be used.





# Entering Threshold Values

Threshold values are set to determine the range for PASS judgements. Both HIGH and LOW threshold values are set. There are three judgement outputs: HIGH, PASS and LOW.

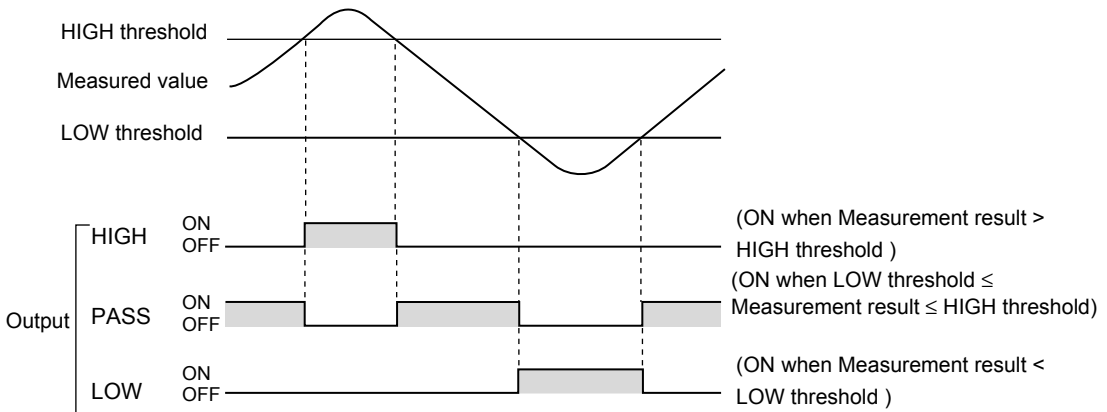

The following table outlines the three methods for setting the threshold values.

Method	Details
Direct input	The threshold values can be set by directly inputting the numeric values. Direct input is useful when you know the dimensions for an OK judgement or when you want to fine-tune threshold values after teaching.
Position teaching	Performs measurement and uses the measurement results to set threshold values. Position teaching is useful when threshold samples, i.e., with the upper and lower limits, can be obtained beforehand.
Two-point teaching	Sets the intermediate point between the first and second teaching points as the threshold value. Two-point teaching is useful to detect small surface steps on the sensing object.
Automatic teaching	Performs measurement continuously while the keys are held down and sets the maximum and minimum measurements during that period as the threshold values. Automatic teaching is useful when you want to set threshold values by starting the device and obtaining real measurements.



Hysteresis (hysteresis width) can also be set for threshold values. Set hysteresis when judgements are unstable to prevent chattering.



p.94

## Inputting Threshold Values Directly

The threshold values can be set by directly inputting the numeric values.

Direct input is useful when you know the dimensions for an OK judgement or when you want to fine-tune threshold values after teaching.

Moving to T Mode

1. Set the mode switch to T.



Setting Threshold Values

2. Move the threshold switch to either H or L, i.e., the threshold to be set.

The current measured value will be displayed on the main display.

The currently set threshold value (either HIGH or LOW, depending on the threshold switch setting) will be displayed on the sub-display.

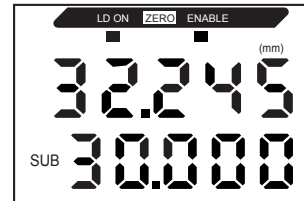

3. Press any Cursor Key.

The leftmost digit of the sub-display will flash.

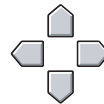

4. Use the Cursor Keys to set the threshold value.



--- Moves from one digit to another.



--- Changes the current value.

5. Press the ENT Key to confirm the setting.

The setting will be registered.



Countermeasures for Setting Errors

If ERR LH or ERR HL is displayed, the following error has occurred.

- HIGH threshold value < LOW threshold value
- HIGH threshold value - LOW threshold value < hysteresis width

Hysteresis Setting p.94

If an error is displayed, the threshold values have not been updated.

Set the threshold values again.



## Position Teaching

Performs measurement and uses the measurement results to set threshold values. Position teaching is useful when threshold samples, i.e., with the upper and lower limits, can be obtained beforehand.

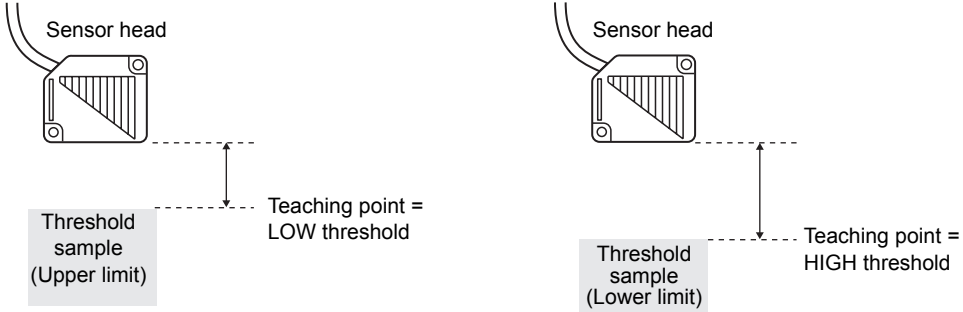

Hold, trigger mode, and scaling settings that have been made before teaching are reflected in the teaching measurements.

CHECK!

### Moving to T Mode

1. Set the mode switch to T.



### Setting Threshold Values

2. Move the threshold switch to either H or L, i.e., the threshold to be set.

The current measured value will be displayed on the main display.

The currently set threshold value (either HIGH or LOW, depending on the threshold switch setting) will be displayed on the sub-display.

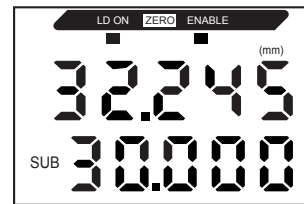

3. Place the threshold sample in position.

The main display value changes.

4. Press the ENT Key for at least one second and then release.



The measured value at the point that the ENT Key is released will be set as the threshold value.

This threshold value will be shown on the sub-display.



When [ERRLH] or [ERRHL] is displayed p.89



The threshold values set using position teaching can be changed using direct input. This is useful when setting judgement tolerances for measured values.

CHECK!

p.89

## Two-point teaching

Performs measurement on two samples and uses the intermediate value of the two measurement results to set threshold values.

Two-point teaching is useful when you want to detect subtle differences between the standard sample and defective samples.

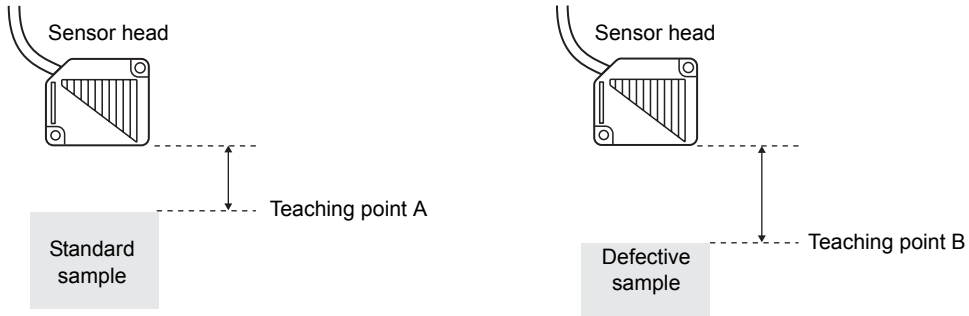

The threshold can be calculated by the following equation.

$$\text{Threshold} = (\text{Teaching point A} + \text{Teaching point B}) / 2$$



Hold, trigger mode, and scaling settings that have been made before teaching are reflected in the teaching measurements.

CHECK!

### Setting Teaching point A

- Set the teaching point A by following steps 1. to 4. of the position teaching procedure.



### Setting Threshold Values

- Place a defective sample in position.  
The main display value changes.
- Press the ENT Key for at least three seconds and then release.



The measured value at the point that the ENT Key is released will be set as the value for teaching point B to set threshold value.

This threshold value will be shown on the sub-display.



When [ERRLH] or [ERRHL] is displayed p.89



The threshold values set using two-point teaching can be changed using direct input. This is useful when setting judgement tolerances for measured values.

CHECK!



p.89

## Automatic Teaching

When automatic teaching is executed, measurement is performed continuously while the keys are held down, and the maximum and minimum measurements during that period are set as the threshold values.

Automatic teaching is useful when you want to set threshold values by starting the device and obtaining real measurements.

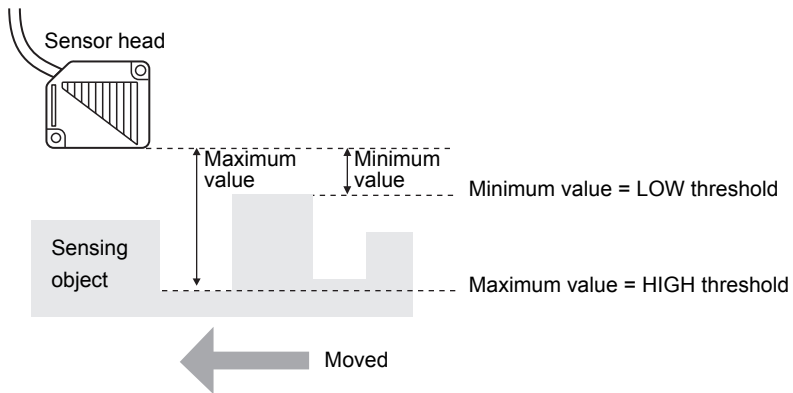

Hold, trigger mode, and scaling settings that have been made before teaching are reflected in the teaching measurements.

---

Moving to T Mode

---

1. Set the mode switch to T.



2. Start the device.



The threshold switch can be set to either position. Both HIGH and LOW thresholds will be set, regardless of the switch setting.

Setting Threshold Values

**3.** Start measurement.

Measurement will continue while the ENT and RIGHT Keys are held down.  
[AUTOT] will flash on the sub-display.



**4.** Release the ENT and RIGHT Keys to end measurement.

The maximum measured value during the measurement period will be set as the HIGH threshold value and the minimum will be set as the LOW threshold value.

The new threshold value (either HIGH or LOW, depending on the threshold switch setting) will be displayed on the sub-display.



When ERR LH is displayed p.89



The threshold values set using automatic teaching can be changed using direct input. This is useful when setting judgement tolerances for measured values.

CHECK!



p.89

## Hysteresis Setting

Set the hysteresis width for the upper and lower limits of judgements if the HIGH, PASS, or LOW judgement is unstable near the threshold values.

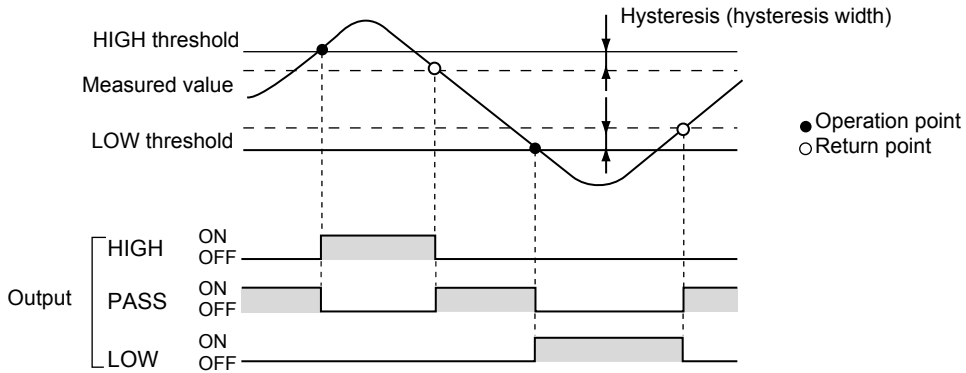

Hysteresis width settings are disabled when previous value comparison is used.



p.86

**CHECK!** To prevent self-trigger chattering, set hysteresis for the self-trigger.



p.78

### Moving to FUN Mode and HYS

1. Set the mode switch to FUN.
2. Use the LEFT and RIGHT Keys to display [HYS] on the main display.
3. Press the UP or DOWN Key.  
The leftmost digit of the sub-display will flash.
4. Use the Cursor Keys to enter the hysteresis width.
5. Press the ENT Key to confirm the setting.  
The setting will be registered.



RUN T FUN

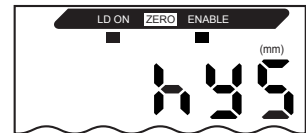

--- Moves from one digit to another.



--- Changes the current value.



### Countermeasures for Setting Errors

If [ERROV] is displayed, [HIGH threshold – LOW threshold] is smaller than the hysteresis width.

If an error is displayed, the threshold values have not been updated.

Set the values again or change the threshold values.



# Linear Output

## Output Settings (Monitor Focus)

Linear output refers to the conversion of measurement results to a 3 to 21mA current output or a -5 to 5V voltage output. The relationship between displayed measured values and output values can be set freely. Match the settings to suit the connected external device.

Enter the output values for any two current values or voltage values to set the output range.

Example: Setting 35mm to 4mA Output and 45mm to 20mA Output (for Current Output)

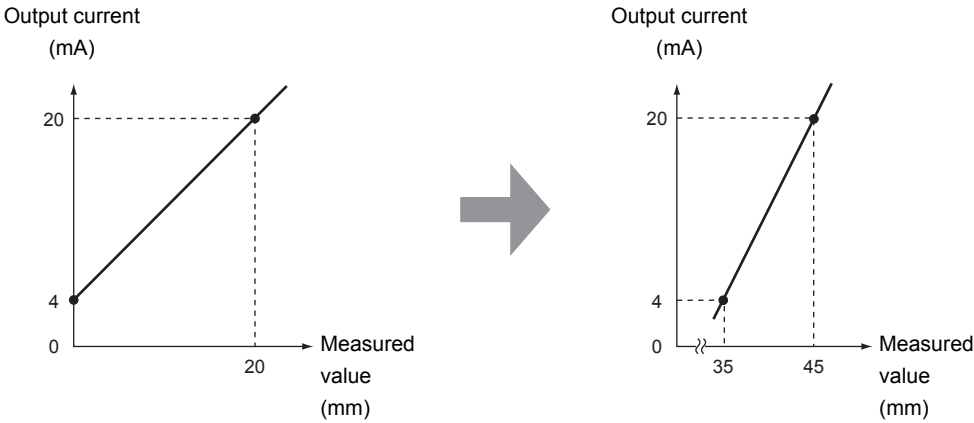

Separate the two specified points by at least 1% of the rated measurement range for the connected Sensor.

CHECK!

For example, the rated measurement range for the ZX-LD40 Sensor is 20mm. Therefore, the two specified points must be separated by 0.2mm min.



Using the Zero Reset Function

Zero reset is released when monitor focus is set. Execute the zero reset again after setting monitor focus.

CHECK!

 Zero Reset, p.116



## Section 5 DETAILED SETTINGS

This section describes how to set the output range, using an example of current output with a range with the following conversions: 35mm to 4 mA and 45mm to 20 mA. Change the values in this example for voltage output as necessary.

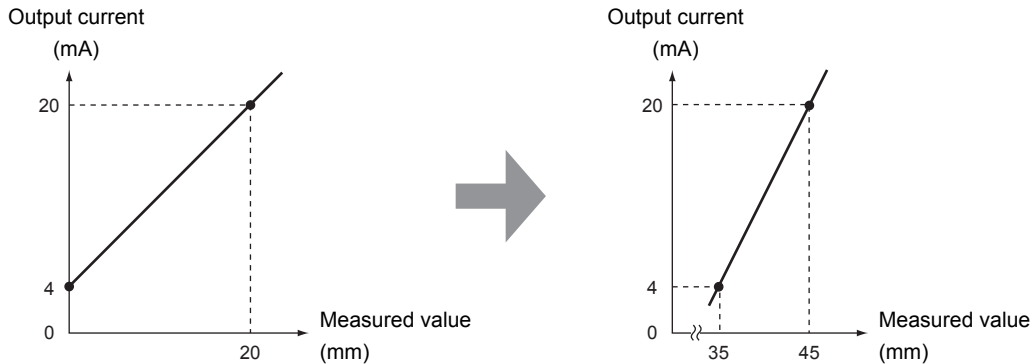

1. Turn OFF the power supply to the Amplifier Unit.
2. Move the current/voltage switch to current output. The switch is found on the bottom of the Amplifier Unit.  
The default setting is voltage output.

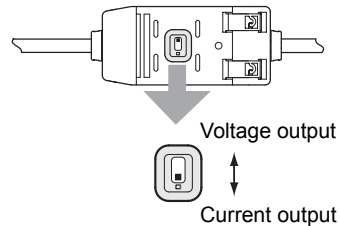

Moving to FUN Mode and SPCL

3. Turn ON the power supply and move the mode switch to FUN.
4. Use the LEFT and RIGHT Keys to display [SPCL] on the main display.



Moving to FOCUS

5. Press the UP or DOWN Key.  
The sub-display will flash.
6. Use the UP and DOWN Keys to display [SET] or [ALL].
7. Press the ENT Key.



8. Use the LEFT and RIGHT Keys to display FOCUS on the main display.

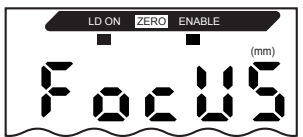

Selecting Current (mA) or Voltage (V) Output

9. Press the UP or DOWN Key.



The sub-display will flash.



10. Display [mA].



Always select the same output as the current/voltage switch selection on the bottom of the Amplifier Unit.

Setting the First Point (A)

11. Press the ENT Key.



The display will change to the settings for the first point (A).  
The output current will be displayed on the main display.  
The measured value will be displayed on the sub-display and the leftmost digit will flash.

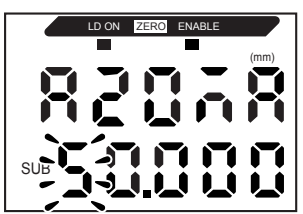

12. Set the output current value and the corresponding measured value for the first point.

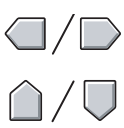

--- Moves from one digit to another.  
--- Changes the current value.

Set a measured value within the measurement distance.  
If scaling or calculation has been set, set a value that reflects those settings.



The flashing digit, i.e., the digit for which a value can be set, will change as shown in the diagram.

Digit shift on sub-display

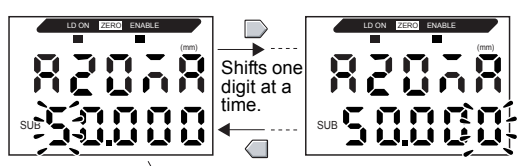

Switching from the sub-display to the main display and vice versa  
(From the leftmost/rightmost digit of the sub-display)

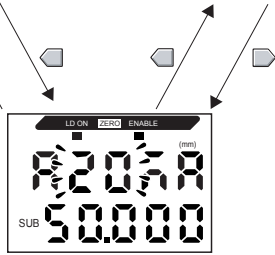

**13.** Press the ENT Key to confirm the setting.

The setting for the first point will be confirmed.  
The screen for setting the second point correction value will be displayed.

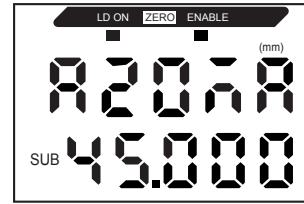

Setting the Second Point (B)

**14.** Use the same procedure as for the first point to set the output current value and corresponding measurement result for the second point.

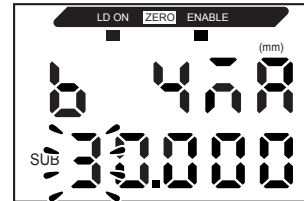

**15.** Press the ENT Key to confirm the setting.

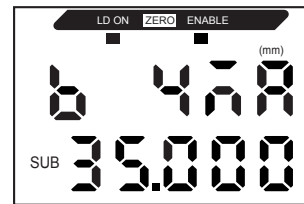

Confirming Completion of Monitor Focus Settings

The display will read [OK] if monitor focus has been set correctly.

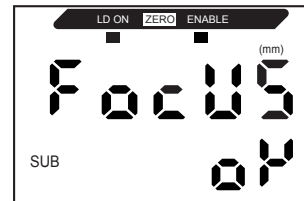

If not, the display will show [NG].

If [NG] is displayed, check the following points and execute the monitor focus again.

- Is the measured value set on the sub-display within the measurement distance (with scaling and calculation settings reflected if set)?
- Are the first and second points separated by at least 1% of the rated measurement distance?
- Are the current (or voltage) values for the two points the same?

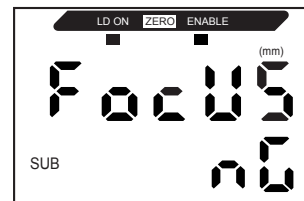

# Correcting Linear Output Values

Discrepancies may occur between the linear output current (or voltage) values set on the Amplifier Unit and the actual current (or voltage) values measured due to the conditions for the connected external device or other factors. The linear output correction function can be used to correct this discrepancy.

The output values are corrected by entering the correction value for the current or voltage values for any two points.



Set the monitor focus function and select either current or voltage output beforehand. p.95

This section uses a current output as an example. Change the values in this example for voltage output as necessary.

1. Connect the linear output to an external ammeter.

Moving to FUN Mode and SPCL

2. Turn ON the power supply and move the mode switch to FUN.



3. Use the LEFT and RIGHT Keys to display [SPCL] on the main display.



Moving to LEFT-ADJ

4. Press the UP or DOWN Key.  
The sub-display will flash.



5. Use the UP and DOWN Keys to display [SET] or [ALL].



**Section 5**  
**DETAILED SETTINGS**

**6.** Press the ENT Key.



**7.** Use the LEFT and RIGHT Keys to display [L-ADJ] on the main display.



The units for the monitor focus settings (mA or V) will be shown on the sub-display.

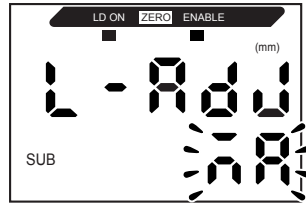

**8.** Press the ENT Key.



The display will change to the settings for the first point (A).  
The output current will be displayed on the main display.  
The correction value will be displayed on the sub-display and the leftmost digit will flash.

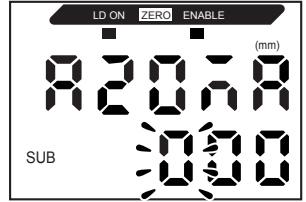

Setting the First Point (A)

**9.** Set the output current and correction values for the first point.



----- Moves from one digit to another.



----- Changes the current value.

Adjust the correction value on the sub-display so that the ammeter reading and the output current shown on the main display are the same.  
The larger the correction value, the larger the output current.

The correction value can be set within the range -999 to 999.

To set a negative value, make the leftmost digit of the sub-display flash and change the value.

If the correction value changes by 4, the linear output will change by approx. 1.4µA(0.7mV).



The flashing digit, i.e., the digit for which a value can be set, will change as shown in the diagram.

CHECK! Digit shift on sub-display

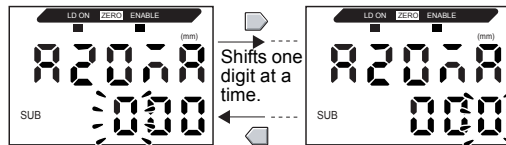

Switching from the sub-display to the main display and vice versa  
(From the leftmost/rightmost digit of the sub-display)

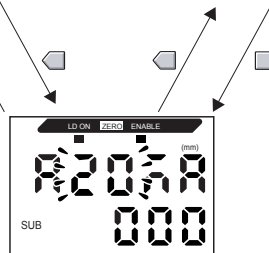

**10.** Press the ENT Key to confirm the setting.

The correction value for the first point will be confirmed.  
The screen for setting the second point correction value will be displayed.



Setting the Second Point (B)

**11.** Use the same procedure as the first point to set the correction value for the second point.

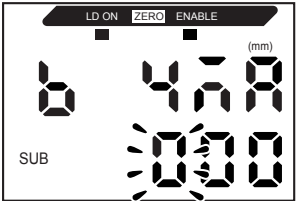

**12.** Press the ENT Key.



Confirming Setting Results

If linear output correction has been registered correctly, the sub-display will show [OK].

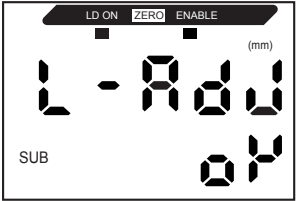

If not, the display will show [NG].  
Check that the current (or voltage) value for the two points are not the same and execute again.

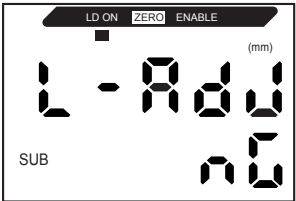

## Output Settings for Non-measurement

The linear output method for when a reset is input can be set.

Selection	Outputs	
	Judgement outputs	Linear output
KEEP (Default)	The status immediately before measurement is stopped is held and output.	
CLAMP	All OFF.	Outputs the set CLAMP value. The following options are available. <ul style="list-style-type: none"> <li>For current output: 3 to 21mA or maximum (approx. 23mA)</li> <li>For voltage output: -5 to 5V or maximum (approx. 5.5V)</li> </ul>



CHECK!

- For Hold Measurements  
Even if [KEEP] is set, the output before the first hold value is obtained will be the same as CLAMP.
- Even in FUN mode, the outputs will be made according to the non-measurement settings.

Moving to FUN Mode and SPCL

- Set the mode switch to FUN.



- Use the LEFT and RIGHT Keys to display [SPCL] on the main display.



Moving to RESET

- Press the UP or DOWN Key.  
The sub-display will flash.



- Use the UP and DOWN Keys to display [ETC] or [ALL].



- Press the ENT Key.



- Use the LEFT and RIGHT Keys to display [RESET] on the main display.



Selecting Output Status for Non-measurement

- 7.** Press the UP or DOWN Key.  
The sub-display will flash.



- 8.** Use the UP and DOWN Keys to select either [KEEP] or [CLAMP].



- 9.** Press the ENT Key to confirm the setting.  
The setting will be registered.  
Next, set the clamp value if [CLAMP] is selected.



Setting Clamp Values (when CLAMP Is Selected)

- 10.** Use the LEFT and RIGHT Keys to display [CLAMP] on the main display.  
[CLAMP] cannot be displayed if [KEEP] has been selected.



- 11.** Press the UP or DOWN Key.  
The sub-display will flash.



- 12.** Select the clamp value.



- 13.** Press the ENT Key to confirm the setting.  
The setting will be registered.







The following description uses the OFF-delay timer as an example. Make the necessary adjustments if other timers are used.

Moving to FUN mode and TIMER

1. Set the mode switch to FUN.



2. Use the LEFT and RIGHT Keys to display [TIMER] on the main display.



Selecting Timers

3. Press the UP or DOWN Key.  
The sub-display will flash.



4. Use the UP or DOWN Key to select the desired timer type.



5. Press the ENT Key to confirm the setting.  
The setting will be registered.  
If anything other than [OFF] is selected, use the following procedure to set the timer time.



Setting Timer Time (when a Timer Type Other Than OFF Is Selected)

6. Use the LEFT and RIGHT Keys to display [T-TIM] on the main display.  
[T-TIM] cannot be displayed if [OFF] is selected.

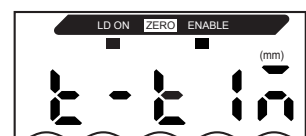

## Section 5 DETAILED SETTINGS

- 7.** Press the UP or DOWN Key.  
The leftmost digit of the sub-display will flash.



- 8.** Use the Cursor Keys to set the timer time (ms).



----- Moves from one digit to another.



----- Changes the current value.

- 9.** Press the ENT Key to confirm the setting.  
The setting will be registered.



# Section 6

## AUXILIARY FUNCTIONS

☒ Measuring with Multiple Amplifier Units	108
☒ Changing the Number of Display Digits	112
☒ Reversing the Display	113
☒ Adjusting Display Brightness (ECO Display)	115
☒ Using the Zero Reset Function	116
☒ Key Lock Function	122
☒ Initializing Settings Data	123

# Measuring with Multiple Amplifier Units

This section describes the settings when Calculating Units are used to connect multiple Amplifier Units.

## Performing Calculations

Measurement results can be calculated between 2 Amplifier Units. The expression is set on the CH2 Amplifier Unit and the calculation results are also output from the CH2 Amplifier Unit. Calculations can also be performed between Sensors with different measuring ranges.

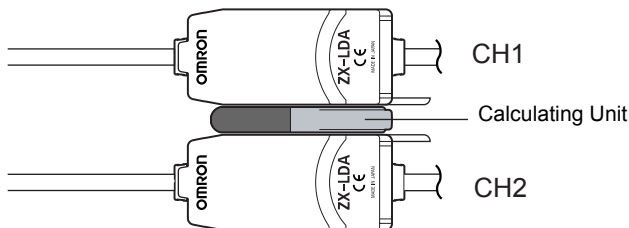

The 3 types of expressions are outlined in the following table.

Expression type	Description
A+B	2 Finds the sum of the measurement results for two Amplifier Units.
A-B	2 Finds the difference between the measurement results for two Amplifier Units. (A: CH2 Amplifier Unit; B: CH1 Amplifier Unit.)
THICK	2 Finds the thickness of a sensing object clamped between two Sensor Heads.



CHECK!

The response time of the CH2 Amplifier Unit to which an expression is set will be prolonged by 1.0ms. Since the response time is influenced by the number of samples to average, the actual response time will be "response time based on the number of samples to average + 1.0ms".



Setting the Number of Samples to Average p.66



CHECK!

- This calculation function is not possible with old model ZX-LDA Amplifier Units.
- For calculation using ZX-E and ZX-T series Amplifier Units, contact your OMRON representative.

## ■ Adding and Subtracting Measurement Results

The expression  $A+B$  or  $A-B$  is used. All settings are made on the CH2 Amplifier Unit.

Moving to FUN and CALC

1. Set the mode switch to FUN on the CH2 Amplifier Unit. 

2. Use the LEFT and RIGHT Keys to display [CALC] on the main display. 



Selecting Expressions

3. Press the UP or DOWN Key.  
The sub-display will flash.



4. Use the UP or DOWN Key to select the desired expression.



5. Press the ENT Key to confirm the setting.  
The setting will be registered.



■ **Finding Thicknesses**

The expression [THICK] is used. Prepare a sensing object of known thickness beforehand (standard sensing object). All settings are made on the CH2 Amplifier Unit.

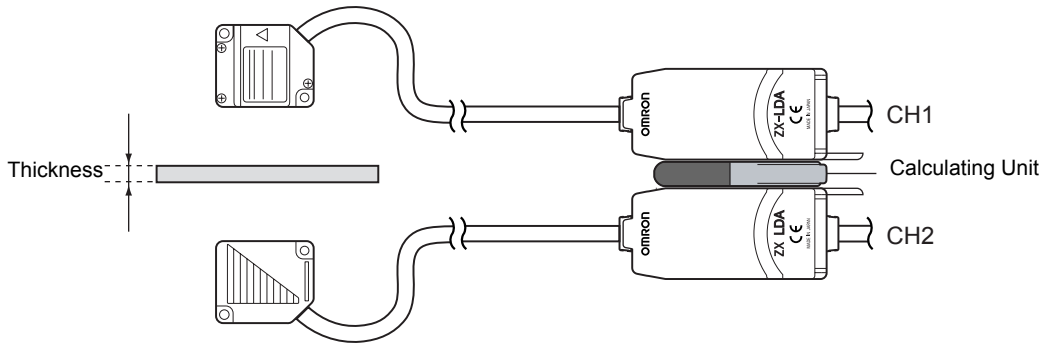

Moving to FUN and CALC

**1.** Place the standard sensing object in positions.

**2.** Set the mode switch to FUN on the CH2 Amplifier Unit.



**3.** Use the LEFT and RIGHT Keys to display [CALC] on the main display.



Selecting Expressions

**4.** Press the UP or DOWN Key.  
The sub-display will flash.



**5.** Use the UP and DOWN Keys to display [THICK] on the sub-display.



**6.** Press the ENT Key to confirm the setting.



Setting Thicknesses

7. Use the LEFT and RIGHT Keys to display [THICK] on the main display.

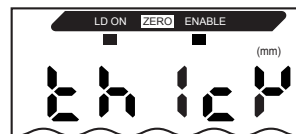

8. Press the UP or DOWN Key.

The leftmost digit of the sub-display will flash.



9. Set the thickness of the standard sensing object.

Enter the actual dimensions of the reference object.

The position of the decimal point can be changed using the next steps.



--- Moves from one digit to another.



--- Changes the current value.

10. Press the ENT Key to confirm the setting.

The numeric values will be confirmed and the decimal point will flash.



11. Use the LEFT and RIGHT Keys to move the decimal point.



12. Press the ENT Key to confirm the setting.

The scaling values (A and B) are registered for both Amplifier Units.

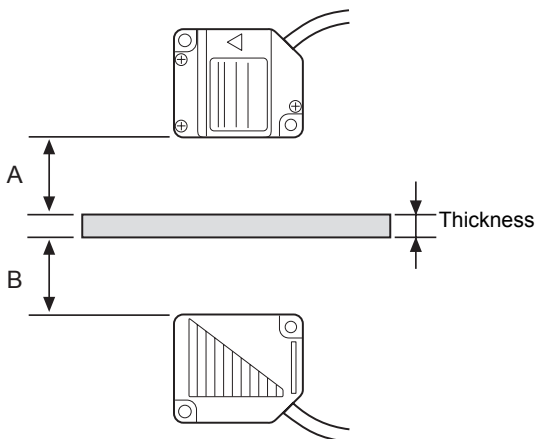

Countermeasures for Setting Errors

If the display shows [E-THK], the standard sensing object is outside the measurement distance. (The ENABLE indicator will not be lit.)

Adjust the position of the reference object until the ENABLE indicator is lit on both Amplifier Units and execute the measurement again.

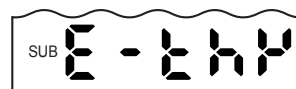



## Changing the Number of Display Digits

Select the number of digits for the main and sub-displays in RUN mode. The default setting is 5 digits. When 4 or less digits are set, the digits are disabled from the rightmost digit first. If 0 is set, all the digital displays will go out.

Moving to FUN and SPCL

1. Set the mode switch to FUN.



2. Use the LEFT and RIGHT Keys to display [SPCL] on the main display.



Moving to DIGIT

3. Press the UP or DOWN Key.  
The sub-display will flash.



4. Use the UP and DOWN Keys to display [DISP] or [ALL].



5. Press the ENT Key.



6. Use the LEFT and RIGHT Keys to display [DIGIT] on the main display.



Selecting Number of Digits

7. Press the UP or DOWN Key.  
The sub-display will flash.



8. Use the UP and DOWN Keys to select the desired number of display digits.



9. Press the ENT Key to confirm the setting.



# Reversing the Display

The main and sub-digital displays can be reversed, i.e., be turned upside down. The Cursor Key operation will also be reversed. This function is useful when mounting the Amplifier Unit upside down on a device.

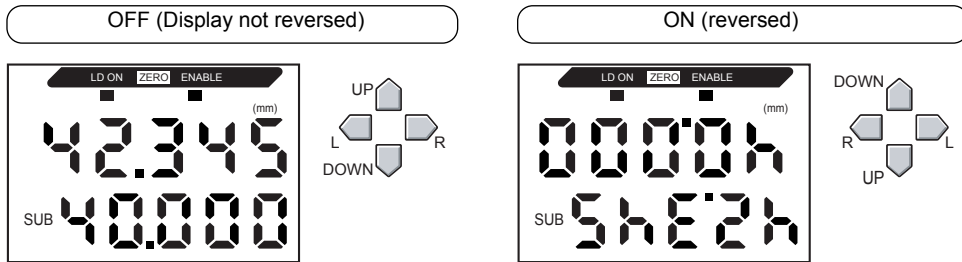

Moving to FUN and SPCL

1. Set the mode switch to FUN.
2. Use the LEFT and RIGHT Keys to display [SPCL] on the main display.

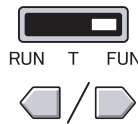

Moving to DREV

3. Press the UP or DOWN Key.  
The sub-display will flash.
4. Use the UP and DOWN Keys to display [DISP] or [ALL].
5. Press the ENT Key.
6. Use the LEFT and RIGHT Keys to display [DREV] on the main display.

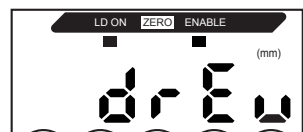
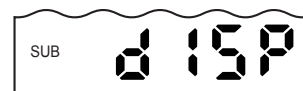

## Section 6 AUXILIARY FUNCTIONS

Selecting Whether or Not to Invert Display

- 7.** Press the UP or DOWN Key.  
The sub-display will flash.



- 8.** Select either [OFF] or [ON].  
OFF: Display not reversed (default)  
ON: Display reversed



- 9.** Press the ENT Key to confirm the setting.  
The setting will be registered.  
When [ON] is selected, the display will be reversed.

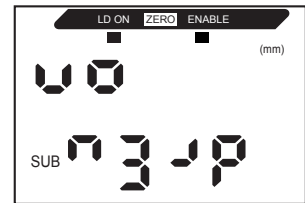

# Adjusting Display Brightness (ECO Display)

When the ECO display function is used, the digital displays are not lit, reducing current consumption.

## Moving to FUN and SPCL

1. Set the mode switch to FUN.



2. Use the LEFT and RIGHT Keys to display [SPCL] on the main display.



## Moving to ECO

3. Press the UP or DOWN Key.  
The sub-display will flash.



4. Use the UP and DOWN Keys to display [DISP] or [ALL].



5. Press the ENT Key.



6. Use the LEFT and RIGHT Keys to display [ECO] on the main display.



## Selecting Whether or Not to Use ECO Display

7. Press the UP or DOWN Key.  
The sub-display will flash.



8. Select either [OFF] or [ON].  
OFF: Normal display (default)  
ON: ECO display



9. Press the ENT Key to confirm the setting.  
The setting will be registered.  
When [ON] is selected, the display will become dark.



# Using the Zero Reset Function

When the zero reset function is used, the reference value "0" is registered as the height and the measured value can be displayed and output as a positive or negative deviation (tolerance) from the reference value.

In RUN mode, the measured value can be reset to 0 at any timing during measurement.

Example 1: Using the Height of Sensing Object Registered as the Reference Value and the Tolerance Output as the Measured Value

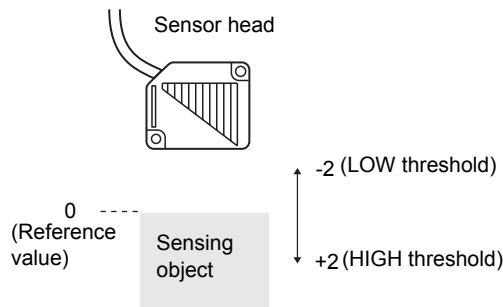

Example 2: Using the Height of Sensing Object as the Measured Value with an Offset Set to 10

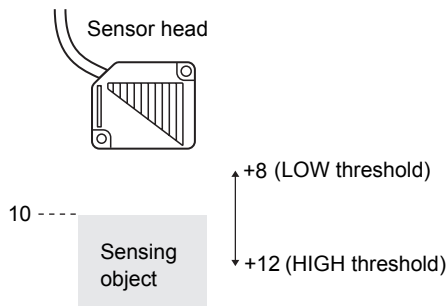

Example 3: Using Zero Reset to Measure Steps in Sensing Object (Zero Reset at Each Measurement)

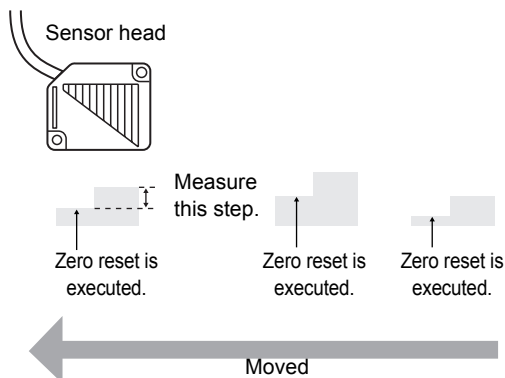

When resetting zero for each measurement, change the settings so that the zero reset memory is disabled.

p.120

## Setting Offset Values

Set an offset value when the reference value for zero reset is a value other than 0.

Moving to FUN and SPCL

1. Set the mode switch to FUN.



2. Use the LEFT and RIGHT Keys to display [SPCL] on the main display.



Moving to ZRDSP

3. Press the UP or DOWN Key.  
The sub-display will flash.



4. Use the UP and DOWN Keys to display [ETC] or [ALL].



5. Press the ENT Key.



6. Use the LEFT and RIGHT Keys to display [ZRDSP] on the main display.



Setting Offset Values

7. Press the UP or DOWN Key.  
The leftmost digit of the sub-display will flash.



8. Set the desired offset value.



--- Moves from one digit to another.



--- Changes the current value.

9. Press the ENT Key to confirm the setting.  
The setting will be registered.



## Executing Zero Reset

When the zero reset function is used, the measured value can be reset to a reference value of 0 when the ENT key is pressed or an external signal is input.

If zero reset has already been executed, that value will be overwritten. The settings are saved even if the power is turned OFF (default).

This memory setting can be changed so that the zero reset settings are not saved when the power is turned OFF.



Zero reset memory p.120



Linear Output

The measured value when zero reset is executed will be the center value in the linear output range.

CHECK!

When monitor focus is set, the measured value will be the center value between the two points set for monitor focus.



Monitor focus p.95

Example:

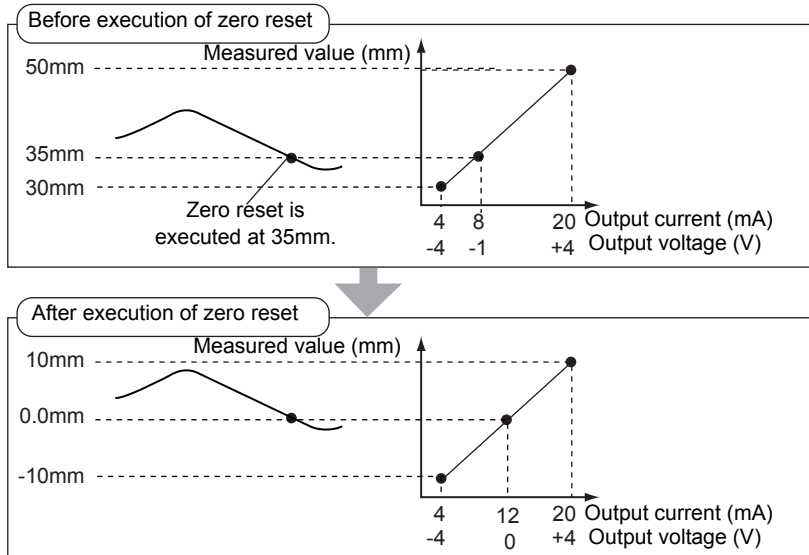

The minimum display value is -19999, and the maximum display value is 59999. If the measured value is below the minimum value after execution of zero reset, "-19999" will be displayed. "59999" will be displayed if the measured value is above the maximum value.

CHECK!

Zero reset can be executed only if the measured value is within  $\pm 10\%$  of the rated measuring range.

1. Place the reference sensing object in position.
2. Set the mode switch to RUN.
3. Press the ENT Key for more than one second or input the zero reset signal from an external device (for 800 ms max.).

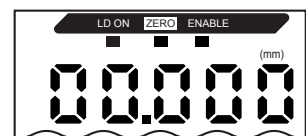
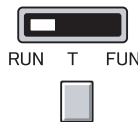

The reference value will be registered and the zero reset indicator will be lit.

The tolerance for the registered reference value will be displayed on the main display.

## Releasing Zero Reset

1. Set the mode switch to RUN.



2. Hold the ENT and RIGHT Keys down together for about three seconds.



To release zero reset from an external device, input the zero reset signal for one second minimum.



Zero reset will be released and the zero reset indicator will turn OFF.



## Saving Zero Reset Level (Zero Reset Memory)

Select whether or not to hold the measured value zero reset level when the power is turned OFF.

Selection	Details
ON	Saves zero reset level when the power is turned OFF.
OFF (default)	Zero reset is released when the power is turned OFF.

Turn OFF zero reset memory if, as in the example below, the zero point is reset for each measurement.

Example: Measuring Steps in Sensing Objects

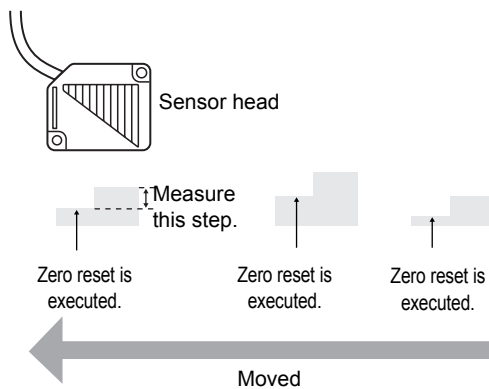

CHECK!

- When turning the power ON, if you want to keep the zero reset level data that was in effect when the power was turned OFF last time, make sure that zero reset memory is enabled. If zero reset memory is enabled, the zero reset level data will be written in the Amplifier Unit non-volatile memory (EEPROM) at each zero reset. The EEPROM can be written a maximum of 100,000 times. Writing the zero reset level for each measurement can, therefore, use up the life of the memory and lead to malfunctions.
- Unlike the old models ZX-LDA11 and LDA41, zero reset memory is disabled by default to protect the EEPROM in the case of ZX-LDA11-N and LDA41-N. Thus, care must be taken when using zero reset memory with the old models ZX-LDA11/LDA41.
- Even if zero reset memory is disabled, the zero reset level will be saved if threshold values or other functions have been changed. Zero reset will continue after startup when these functions have been changed.

Moving to FUN and SPCL

1. Set the mode switch to FUN.



2. Use the LEFT and RIGHT Keys to display [SPCL] on the main display.

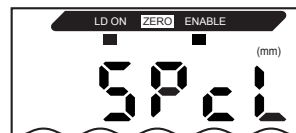

Moving to ZRMEM

3. Press the UP or DOWN Key.  
The sub-display will flash.



4. Use the UP and DOWN Keys to display [ETC] or [ALL].



5. Press the ENT Key.



6. Use the LEFT and RIGHT Keys to display [ZRMEM] on the main display.



Selecting Whether or Not to Enable Zero Reset Memory

7. Press the UP or DOWN Key.  
The sub-display will flash.



8. Select either [ON] or [OFF].  
ON: Zero reset memory enabled  
OFF: Zero reset memory disabled (default)



9. Press the ENT Key to confirm the settings.  
The setting will be registered.



# Key Lock Function

The key lock function disables all Amplifier Unit keys. Once the keys have been disabled, no key input will be accepted until the lock is released. This function is useful to prevent inadvertent changes to settings.

The mode and threshold switches are still enabled even when the key lock function is ON.

## Setting the Key Lock

1. Set the mode switch to FUN.
2. Hold down the UP, DOWN, RIGHT, and LEFT Keys at the same time.  
The main display will display [LOCK].  
The sub-display will display [----].
3. Release the keys once [OK] is displayed on the sub-display.

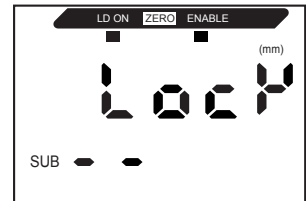
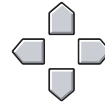

The keys will be locked.

## Releasing the Key Lock

1. Set the mode switch to FUN.
2. Hold down the UP, DOWN, RIGHT, and LEFT Keys at the same time.  
The main display will display [FREE].  
The sub-display will display [----].
3. Release the keys once [OK] is displayed on the sub-display.  
The key lock will be released.

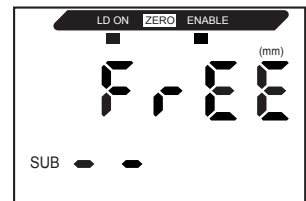
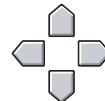

# Initializing Settings Data

This function resets all settings to their default values.

## Default Value

Functions	Default Value
No. of samples to average	When Reflective type sensor head (ZX-LD) is connected: 256 When Through-beam type sensor head (ZX-LT) is connected: 32
Hysteresis width	Reflective type sensor head: 1% of rated measuring range Example: In the case of ZX-LD40, the measuring range is 20 to 50mm. Therefore, the rated measuring range will be 20mm, resulting in hysteresis width of 0.2mm (1% of 20mm). Through-beam type sensor head: 0.5% of detection width (F.S.) Example: In the case of ZX-LT005, the detection width (F.S.) is 5mm. Therefore, the hysteresis width will be 25 $\mu$ m (0.5% of 5mm).
Hold	OFF
Timer	OFF
Special functions	CLOSE
Scaling	OFF
Monitor focus	Minimum value inside rated measuring range: -4V (for voltage output), 4mA (for current output) Maximum value inside rated measuring range: +4V (for voltage output), 20mA (for current output)
Linear output correction	No correction
Display reverse	OFF
ECO mode	OFF
Display digit limit	5 digits (all)
Non-measurement settings	KEEP
Zero reset memory	OFF
HIGH threshold	Maximum display value
LOW threshold	Minimum display value
Standard received light amount setting	OFF
Intensity mode	OFF
Differentiation function	OFF
Zero reset function	Released
Sub-display	Threshold
Gain switching	When Reflective type sensor head (ZX-LD) is connected: AUTO When Through-beam type sensor head (ZX-LT) is connected: WHITE
Auto scale	100-L (Only when Through-beam type sensor head (ZX-LT) is connected)

## Section 6 AUXILIARY FUNCTIONS

1. Set the mode switch to FUN.



2. Use the LEFT and RIGHT Keys to display [INIT] on the main display.

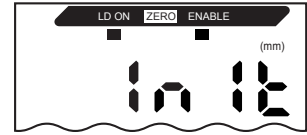

3. Press and hold down the ENT Key.  
The sub-display will display [----].



4. Release the keys once [OK] is displayed on the sub-display.  
The settings will be initialized.



# Section 7

## APPENDIX

☒ Troubleshooting	126
☒ Error Messages and Countermeasures	127
☒ Q&A	129
☒ Glossary	130
☒ Specifications and Dimensions	132
☒ Communication with the Smart Monitor is possible via the Interface Unit	144
☒ Engineering Data	146
☒ Quick Reference for Displays	152
☒ Requirements from Regulations and Standards	155
☒ Index	164

# Troubleshooting

This section describes countermeasures for temporary hardware problems. Check the malfunction in this section before sending the hardware for repair.

Problem	Probable cause and possible countermeasure	Pages
Device restarts during operation.	<ul style="list-style-type: none"> <li>Is the power supply device connected correctly?</li> <li>Are the Interface and Calculating Units connected correctly?</li> </ul>	p.27 p.21
Judgements not output to external device.	<ul style="list-style-type: none"> <li>Are all cables connected correctly?</li> <li>Is the signal line disconnected?</li> <li>Are reset inputs short-circuited?</li> </ul>	p.27
No input signal received.	<ul style="list-style-type: none"> <li>Are all cables connected correctly?</li> <li>Is the signal line disconnected?</li> </ul>	p.27
No communications with personal computer.	<ul style="list-style-type: none"> <li>Is the cable connected correctly?</li> <li>Is the Interface Unit connected correctly?</li> <li>Is the switch under the Interface Unit on the side without the tab?</li> <li>Is the connector pin arrangement correct?</li> </ul>	p.27 p.26 p.144 p.142
Strange linear output levels.	<ul style="list-style-type: none"> <li>Is the switch on the bottom of the Amplifier Unit set to the correct position?</li> <li>Has the correct selection (voltage/current) been made in the monitor focus settings?</li> <li>Linear output levels can be fine-tuned.</li> </ul>	p.95
Nothing displayed on main display or sub-display.	<ul style="list-style-type: none"> <li>Has the number of display digits been set to zero?</li> </ul>	p.112
The main display remains on [-----].	<ul style="list-style-type: none"> <li>Has a timing input been made while hold is enabled and the trigger type has been set to TIMIG?</li> <li>If the hold function is enabled and the trigger type is [UP] or [DOWN], has the self-trigger level been set to an appropriate value?</li> </ul>	p.76
Abnormal distance is displayed when the object is clearly outside measurement range.	<ul style="list-style-type: none"> <li>This problem may occur due to the characteristics of the sensor. Make sure that the distance to the sensing object is appropriate.</li> <li>This problem may be solved by selecting a fixed measurement gain in the measurement sensitivity setting.</li> </ul>	p.74
[LDDWN] is displayed on the main display when the power is turned ON.	The laser of the sensor head has deteriorated. Replace the Sensor Head.	p.21
The measured values fluctuate and are not stable depending on day and time.	This problem may be due to temperature characteristics. Execute zero reset periodically using the standard object to correct this problem.	p.116

# Error Messages and Countermeasures

This section outlines the error messages displayed on the main display and the countermeasures for those messages.





Display	Error	Countermeasure	Pages
E-CHL	There are two Sensors but only one Amplifier Unit connected	<ul style="list-style-type: none"> <li>If two Amplifier Units have been connected, turn OFF the power supply and check that the Amplifier and Calculating Units are connected correctly.</li> <li>If only one Amplifier Unit is being used, connect another Amplifier Unit temporarily and turn OFF the two-sensor operation, or initialize the settings data.</li> </ul>	p.11 p.21  p.108 p.123
E-BRT (flashing) (*1)	The received light intensity is saturated or a distance measurement error has occurred.	<ul style="list-style-type: none"> <li>If the gain setting has been changed, either set the optimum gain or set the gain to auto mode.</li> <li>If this does not solve the problem, use a suitable workpiece.</li> </ul> <p>Operation will recover automatically when the error is solved.</p>	p.74
E-DAT	Two-sensor operation communications data error	<ul style="list-style-type: none"> <li>Change the mode for the CH1 Amplifier Unit to RUN.</li> <li>Turn OFF the power supply and check that the Amplifier and Calculating Units are connected correctly.</li> </ul> <p>Replace the Amplifier Unit or the Calculating Unit if the above countermeasures do not solve the problem.</p> <ul style="list-style-type: none"> <li>If Smart Monitor is used, this error may occur depending on the communications conditions.</li> </ul>	p.11 p.21 p.34
E-DRK (flashing) (*1)	The received light intensity is insufficient or a distance measurement error has occurred.	<ul style="list-style-type: none"> <li>If the gain setting has been changed, either set the optimum gain or set the gain to auto mode.</li> <li>If this does not solve the problem, use a suitable workpiece.</li> </ul> <p>Operation will recover automatically when the error is solved.</p>	p.74
E-EEP	EEPROM data error	Hold down the ENT Key for three seconds or longer. Once the data has been cleared, cycle the power supply. Replace the Amplifier Unit if the above countermeasure does not solve the problem.	p.11
E-HED	The Sensor Head is disconnected.	Turn OFF the power supply, check the connection for the Sensor Head, and then turn ON the power supply again.  If this does not solve the problem, the Sensor Head is defective. Replace the Sensor Head.	p.21
E-LUL (flashing) (*1)	A distance error has occurred.	Place a workpiece in the measurement area.  Operation will recover automatically when the error is solved.	p.51
E-SHT	One or all of the judgement outputs are short-circuited.	Turn OFF the power supply, check that the HIGH, PASS, and LOW output lines are not short-circuited, then turn ON the power supply again.	p.27
E-THK	The thickness T is not set for thickness operation.	Set an appropriate thickness T.	p.54







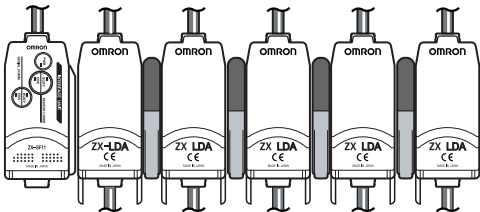

Display	Error	Countermeasure	Pages
ERRLH	An attempt was made to set a numeric value larger than the HIGH threshold value to the LOW threshold value.	Input correct threshold values.	p.88
	HIGH threshold - LOW threshold - hysteresis width		
ERRHL	An attempt was made to set a numeric value smaller than the LOW threshold value to the HIGH threshold value.	Input correct threshold values.	p.88
	HIGH threshold - LOW threshold - hysteresis width		
ERROV	The set numeric value is too large.	Input an appropriate numeric value.	p.38
	HIGH threshold - LOW threshold - hysteresis width		
ERRUD	The set numeric value is too small.	Input an appropriate numeric value.	p.38

(\*1) Displayed only for Reflective-type Sensor Heads.

# Q&A

Question	Answer
Can calculations be performed with ZX-E and ZX-T series Smart Sensors?	Contact your OMRON representative.
Can the ZX-SF11 Interface Unit used with the ZX-LDA11/LDA41 or ZX-E-series Smart Sensors be used with the ZX-LDA11-N/LDA41-N Smart Sensors?	Yes, if the Interface Unit is version 2.0 or later.If the Interface Unit is an earlier version, contact your OMRON representative. (The Interface Unit version can be checked with the Smart Monitor.)
Why does an error occur and settings cannot be made when teaching or directly inputting threshold values?	Threshold values cannot be set using teaching or by direct input if the following condition is not met: HIGH threshold value - LOW threshold value - hysteresis width  p.88
When scaling is executed, an error appears on the sub-display and settings cannot be made.	Scaling cannot be set for one of the following reasons: <ul style="list-style-type: none"> <li>• Scaling has been attempted when the measured value is outside the measurement distance range.</li> <li>• When two-point scaling has been executed, the distance between the measured values for the two points is not 1% or more of the rated measurement range.</li> </ul>  p.72
When monitor focus is executed, why does an error appear on the sub-display and the settings cannot be made?	Monitor focus settings cannot be made when the distance between the two specified points is not 1% or more of the rated measurement range.  p.95
When entering the thickness for thickness calculation, why does an error appear on the sub-display and the settings cannot be made?	The present value is outside the measurement range.Place the sensing object within the measurement range and then enter the thickness.  p.54
Can calculations be performed with 3 or more Amplifier Units?	In the case of ZX-LDA11-N/LDA41-N Amplifier Units, calculations can be performed with up to eight units (CH1 with one of CH2 to CH8). (With the ZX-LDA11/LDA41 Amplifier Units, calculations can be performed with up to two units. Calculations cannot be performed if ZX-LDA and ZX-LDA are used together.)
Can calculations be performed when Sensor Heads with different measurement ranges are connected to 2 Amplifier Units?	Yes if the Sensor Heads are the same type (Reflective type or Through-beam type). However, this is not true in the case of ZX-LDA11/LDA41. Calculations cannot be performed if ZX-LDA and ZX-LDA are used together.)
How many Amplifier Units can be connected and communicated with ZX-SF11?	In the case of ZX-LDA11-N/LDA41-N Amplifier Units, up to five units can be connected. (In the case of the old models ZX-LDA11/LDA41, up to two units can be connected. Communications cannot be performed if ZX-LDA and ZX-LDA are used together.) 
Is warm-up operation still required even if LD-OFF input is cancelled?	Yes. As when the power is turned ON, warm-up operation must be performed for about 10 minutes.

# Glossary

Term	Explanation
Response time	Response time is the time from when the Sensor measures a distance to when the value is output (either as linear output or judgement output). The response time changes depending on the settings for the number of samples to average and calculations.
Measured value	The measured value is the measurement result displayed on the main display of the Amplifier Unit in RUN and T modes. The measured value is the value after all set processing has been completed, e.g., number of samples to average, scaling, calculations, hold, and zero reset.  p.39
Present value	The present value is the current measurement result for the target Amplifier Unit. Some set processing, such as number of samples to average, and scaling, have been completed for the current measured value, but calculation, hold, and zero reset settings are not reflected. Press the LEFT or RIGHT Key in RUN mode to display the present value on the sub-display.  p.39
Linearity	The linearity is given as the error in an ideal straight line displacement output when measuring the standard sensing object. The linearity shows how closely the linear output maintains a linear relationship to the displacement of the sensing (i.e., it shows the accuracy of the linear output).
Linear output	The linear output is analog data output from the linear output line. Either a current or voltage output can be selected. The linear output is made based on the display value and monitor focus settings. The actual value output (the output value) can be displayed on the sub-display by pressing the LEFT or RIGHT Key in RUN mode.  p.39
Judgement outputs	"Judgement outputs" is a general term for the HIGH, PASS, and LOW outputs. The judgement outputs are made in RUN and T mode based on the display values and the threshold, hysteresis width, and timer settings.
Smart Monitor	The Smart Monitor is software (sold separately) developed for Windows 98, 2000 and XP. This software allows communications with ZX-LDA11-N/LDA41-N via the interface unit to make measurement settings, save settings data, display measurement results as graphs, and perform data logging. For the ZX-LDA11-N/LDA41-N Smart Sensors, Smart Monitor version 3.0 or later can be used.  p.10
Measuring range	The measurement distance is the range (distance) that measurement is possible for the connected Sensor Head.  p.135, p.137
Sampling period	Sampling period is the time over which the sensing object is measured when the hold function is being used. The sampling period is determined by the trigger mode and the delay time.  p.76



# Specifications and Dimensions

Amplifier Unit  
ZX-LDA11-N/LDA41-N

(Unit: mm)

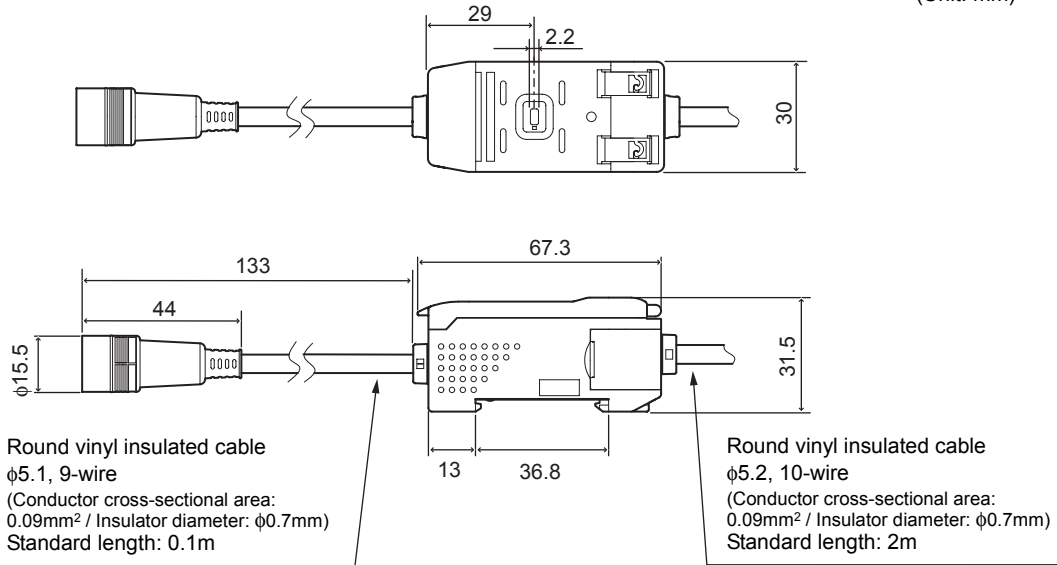

	ZX-LDA11-N	ZX-LDA41-N
Measurement cycle	150μs	
Possible settings for number of samples to average (*1)	1, 2, 4, 8, 16, 32, 64, 128, 256, 512, 1024, 2048, or 4096	
Temperature characteristic	Reflective Sensor type sensor head: 0.01%F.S./°C Through-beam type sensor head: 0.1%F.S./°C	
Linear output (*2)	For current output: 4 to 20 mA/F.S., maximum load 300Ω For voltage output: ±4V, (±5V, 1 to 5V (*3)), output impedance 100Ω	
Judgement outputs (HIGH/PASS/LOW: 3 outputs)	NPN open-collector outputs, 30 VDC, 50 mA max. Residual voltage: 1.2 V max.	PNP open-collector outputs, 30 VDC, 50 mA max. Residual voltage: 2 V max.
LD-OFF input	ON: Supply voltage short-circuited or within supply voltage -1.5 V max. OFF: Open (leakage current: 0.1 mA max.)	
Zero reset input		
Timing input		
Reset input		

	ZX-LDA11-N	ZX-LDA41-N		
Functions	Measured value display Present value display Output value display Set value display Light amount display Resolution display Scaling Display reverse Indicator OFF mode ECO Mode Display digit change Sample hold	Peak hold Bottom hold Peak-to-peak hold Self-up trigger Self-down trigger Average hold Delay hold Delay time setting Previous value comparison Intensity mode (*5) Auto scale(*6) Zero reset Initial reset ON-delay timer	OFF-delay timer One-shot timer Differentiation Sensitivity selection Direct threshold value setting Position teaching Two-point teaching Automatic teaching Hysteresis width change Monitor focus	Non-measurement settings (A-B) calculations (*4) (A+B) calculations (*4) Thickness calculation (*4) Mutual interference (*4) Laser deterioration detection Lock function Zero reset memory
Indicators	Judgement indicators: HIGH (orange), PASS (green), LOW (yellow), 7-segment main display (red), 7-segment sub-display (yellow), Laser ON (green), zero reset (green), enable (green)			
Power supply voltage	12 to 24 VDC ±10%, Ripple (p-p) 10% max.			
Power consumption	3.4 W max. (Sensor connected) (Power supply voltage: 24 V, Current consumption: 140 mA max.)			
Ambient temperature	Operating and storage: 0 to 50°C (with no icing or condensation)			
Ambient humidity	Operating and storage: 35% to 85% (with no condensation)			
Insulation resistance	20 MΩ (at 500 VDC)			
Dialectic strength	1,000 VAC, 50/60 Hz for 1 min			
Vibration resistance (destructive)	10 to 150 Hz, 0.7-mm double amplitude, 80 min each in X, Y, and Z directions			
Shock resistance (destructive)	300 m/s <sup>2</sup> 3 times each in six directions (up/down, left/right, forward/backward)			
Connection method	Prewired (standard cable length: 2 m)			
Weight (packed state)	Approx. 350 g			
Materials	Case: PBT (polybutylene terephthalate), Cover: Polycarbonate			
Accessories	Instruction sheet			

(\*1) The response speed of the linear output is calculated as the measurement period x (No. of samples to average setting + 1).

The response speed of the judgement outputs is calculated as the measurement period x (No. of samples to average setting + 1).

(\*2) Current/voltage can be switched using the switch provided on the bottom of the Amplifier Unit.

(\*3) Setting is possible via the monitor focus function.

(\*4) A Calculating Unit is required.

(\*5) Intensity mode can be used with Reflective type sensor head only.

(\*6) Auto scale can be used with Through-beam type sensor head only.

Sensor Head

■ Reflective type sensor head ZX-LD□□□□/ ZX-LD□□□□L

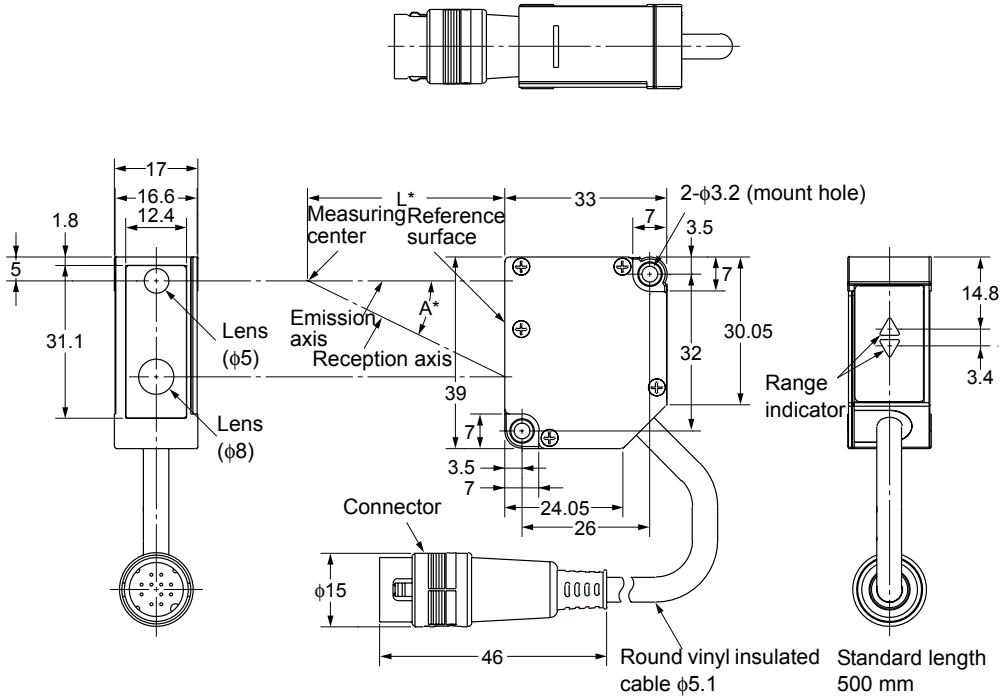

\* For ZX-LD40 (L): L = 40, A = 23°  
 For ZX-LD100 (L): L = 100, A = 11°  
 For ZX-LD300 (L): L = 300, A = 3.8°

Mount hole dimensions

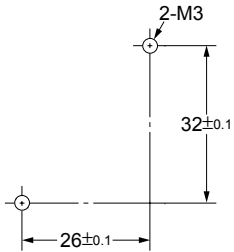

	ZX-LD40	ZX-LD100	ZX-LD300	ZX-LD40L	ZX-LD100L	ZX-LD300L
Applicable Amplifier Units	ZX-LDA11-N/41-N, ZX-LDA11/41					
Measuring center distance	40mm	100mm	300mm	40mm	100mm	300mm
Measuring range	±10mm	±40mm	±200mm	±10mm	±40mm	±200mm
Light source	Red semiconductor laser ( $\lambda=650\text{nm}$ , 1mW max., JIS class 2)					
Beam diameter (*1)	50 $\mu\text{m}$	100 $\mu\text{m}$	300 $\mu\text{m}$	75 $\mu\text{m}$ × 2mm	150 $\mu\text{m}$ × 2mm	450 $\mu\text{m}$ × 2mm
Resolution (*2)	2 $\mu\text{m}$	16 $\mu\text{m}$	300 $\mu\text{m}$	2 $\mu\text{m}$	16 $\mu\text{m}$	300 $\mu\text{m}$
Linearity (*3)	±0.2%F.S. (Entire range)	±0.2%F.S. (80 to 120mm)	±2%F.S. (200 to 400mm)	±0.2%F.S. (32 to 48 mm)	±0.2%F.S. (80 to 120mm)	±2%F.S. (200 to 400mm)
Temperature characteristic (*4)	±0.03%F.S./°C		±0.1%F.S./°C	±0.03%F.S./°C		±0.1%F.S./°C
Ambient temperature	Operating: 0 to 50°C, Storage: -15 to 60°C (with no icing or condensation)					
Ambient humidity	Operating and storage: 35% to 85% (with no condensation)					
Operating ambient illumination	3000 lx (incandescent light)					
Dialectic strength	1,000 VAC, 50/60 Hz for 1 min					
Vibration resistance (destructive)	10 to 150 Hz, 0.7-mm double amplitude, 80 min each in X, Y, and Z directions					
Shock resistance (destructive)	300 m/s <sup>2</sup> 3 times each in six directions (up/down, left/right, forward/backward)					
Degree of protection	IP50					
Materials	PBT (Case), Aluminum (Case cover)					
Weight (packed state)	Approx. 150g					

F.S.: Full scale of measurement

- (\*1) Beam diameter: Measuring center distance. The typical value at the measuring center distance is shown.  
Defined as  $1/e^2$  (13.5%) of the center intensity.  
The beam diameter may sometimes be affected by the ambient condition of the object such as leaked light from the main beam.
- (\*2) Resolution: Fluctuation width ( $\pm 3\sigma$ ) of linear outputs when connected to Amplifier Unit  
(With averaging number set to 4096 and the standard work placed at the measuring center distance)
- (\*3) Linearity: The error in relation to the ideal displacement output straight line when the standard work is measured (May vary with the sensing object.)  
Standard work: White ceramics
- (\*4) Temperature characteristic: Value obtained when the sensor and object (standard work) are fixed with an aluminum jig. (Measured at the measuring center distance)
- (\*5) Incorrect detection may occur outside the measuring range if the object has a high reflective factor.



Reflective type sensor head ZX-LD30V/ZX-LD30VL

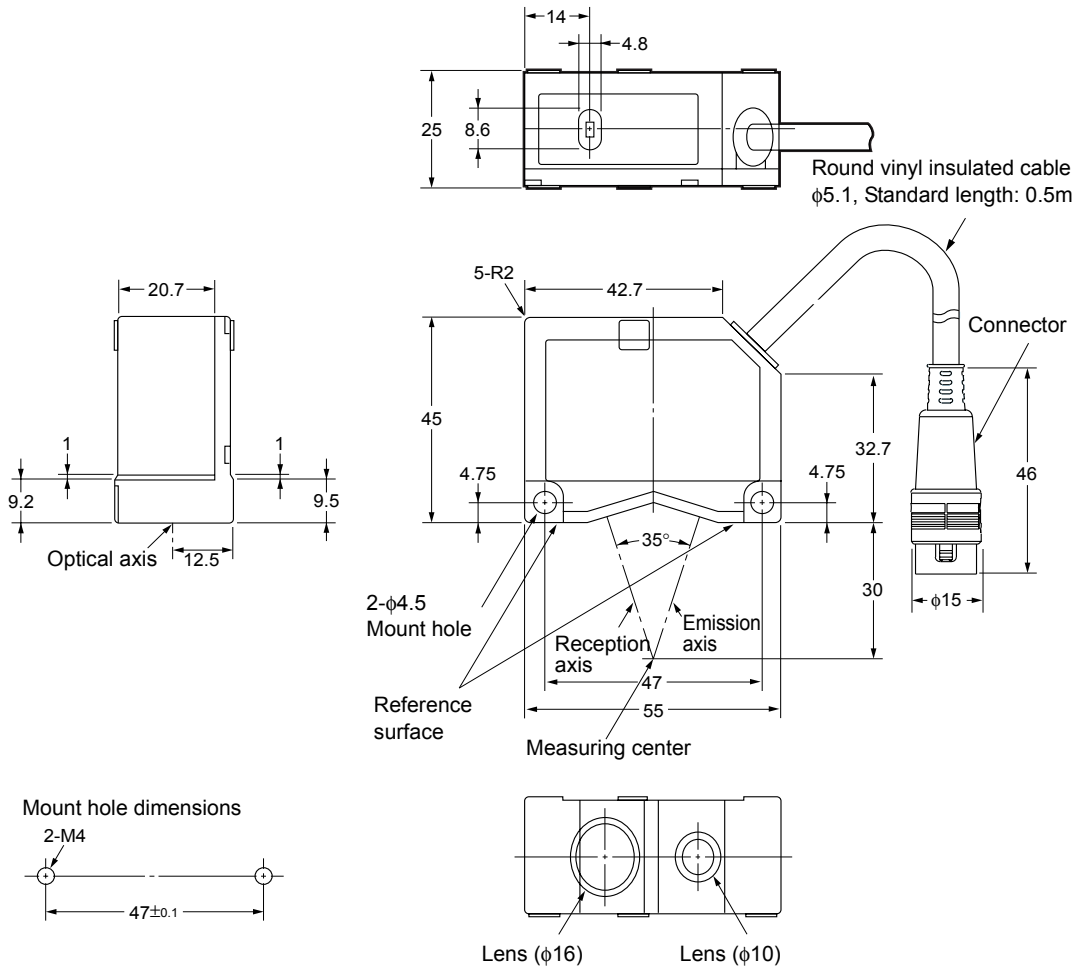

	ZX-LD30V	ZX-LD30VL
Applicable Amplifier Units	ZX-LDA11-N/41-N ZX-LDA11/41	
Measuring center distance	30 mm	
Measuring range	±2 mm	
Light source	Red semiconductor laser ( $\lambda=650\text{nm}$ , 1mW max., JIS class 2)	
Beam diameter (*1)	50 $\mu\text{m}$	75- $\mu\text{m} \times 2\text{mm}$
Resolution (*2)	0.25 $\mu\text{m}$	
Linearity (*3)	±0.2%F.S. (Entire range)	
Temperature characteristic (*4)	±0.03%F.S./°C	
Ambient temperature	Operating: 0 to 50°C, Storage: -15 to 60°C (with no icing or condensation)	
Ambient humidity	Operating and storage: 35% to 85% (with no condensation)	
Ambient illumination	3000 lx (incandescent light)	
Vibration resistance (destructive)	10 to 150 Hz, 0.7-mm double amplitude, 80 min each in X, Y, and Z directions	
Degree of protection	IP40	
Materials	Aluminum die-cast	
Weight (packed state)	Approx. 250g	

F.S.: Full scale of measurement

- (\*1) Beam diameter: Measuring center distance. The typical value at the measuring center distance is shown. Defined as  $1/e^2$  (13.5%) of the center intensity.  
The beam diameter may sometimes be affected by the ambient condition of the object such as leaked light from the main beam.
- (\*2) Resolution: Fluctuation width ( $\pm 3\sigma$ ) of linear outputs when connected to Amplifier Unit (With averaging number set to 4096 and the standard work placed at the measuring center distance)
- (\*3) Linearity: The error in relation to the ideal displacement output straight line when the standard work is measured (May vary with the sensing object. Standard work: White ceramics)
- (\*4) Temperature characteristic: Value obtained when the sensor and object (standard work) are fixed with an aluminum jig. (Measured at the measuring center distance)
- (\*5) Incorrect detection may occur outside the measuring range if the object has a high reflective sensor factor.

■ Through-beam type sensor head ZX-LT001/ZX-LT005

Emitter

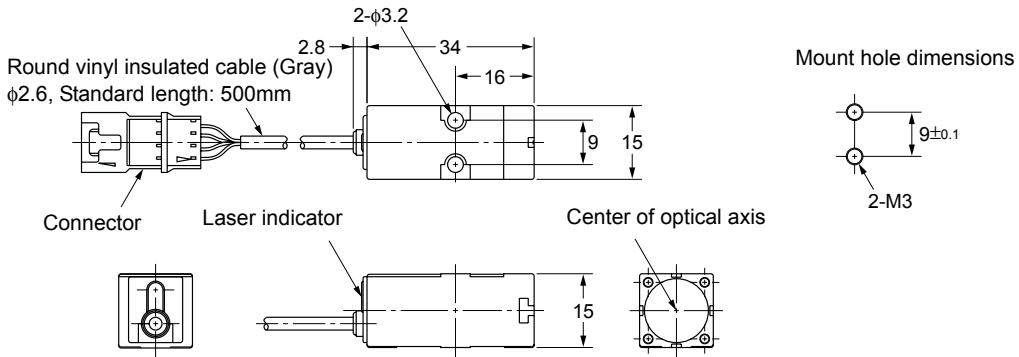

Receiver

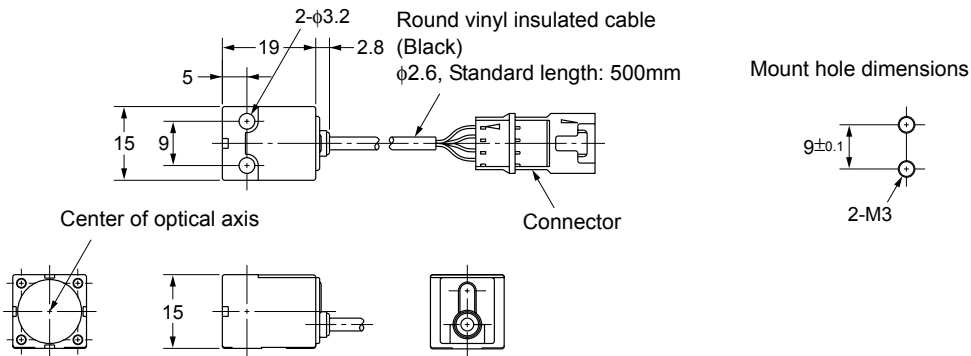

Side View Attachment (ZX-XF12)

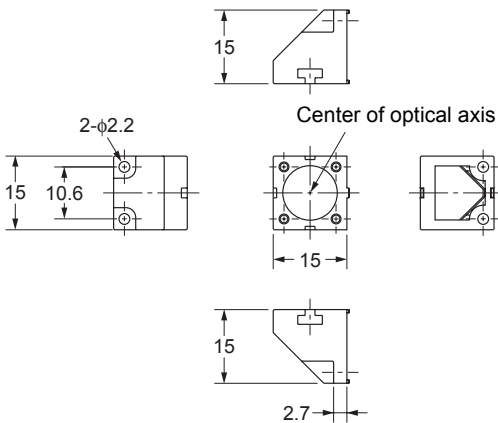

Side View Attachment (ZX-XF22)

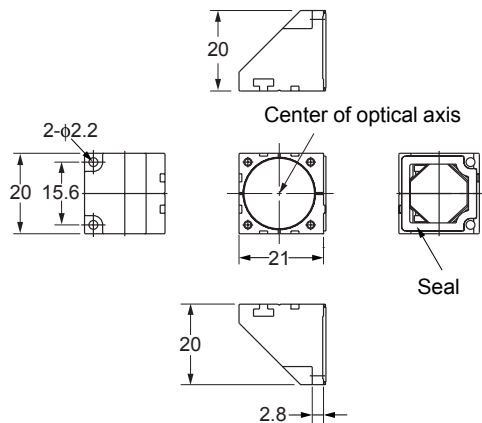

### Through-beam type sensor head ZX-LT010

#### Emitter

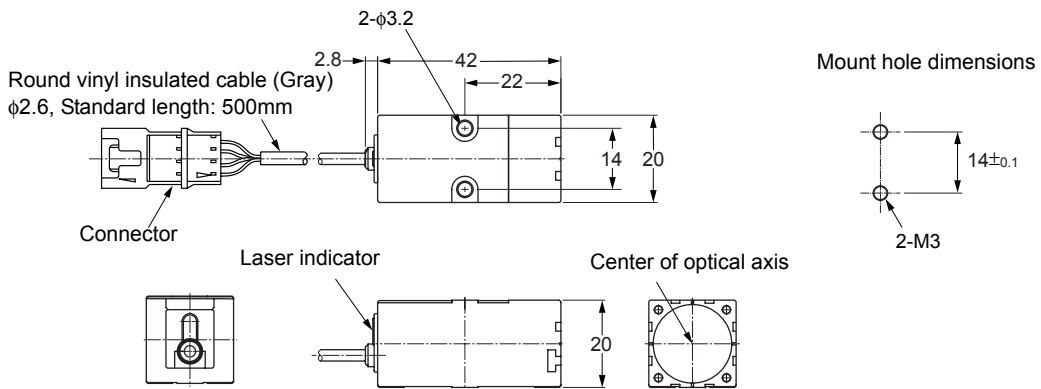

#### Receiver

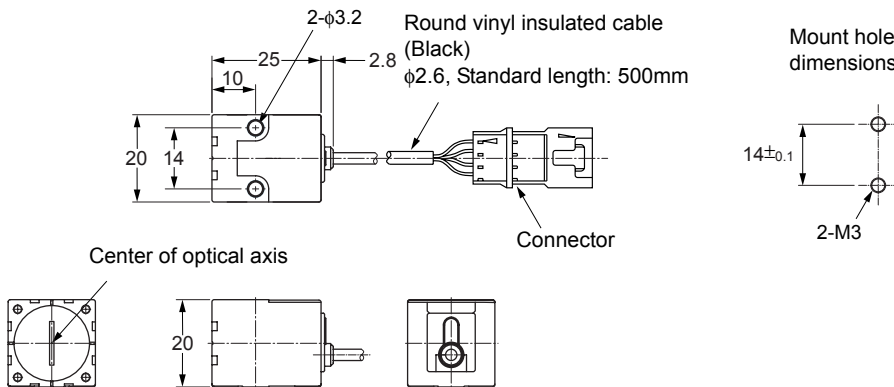

### Through-beam type sensor head ZX-LT030

#### Emitter

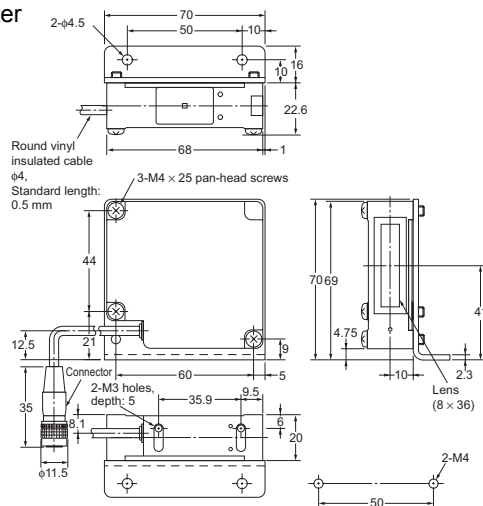

#### Receiver

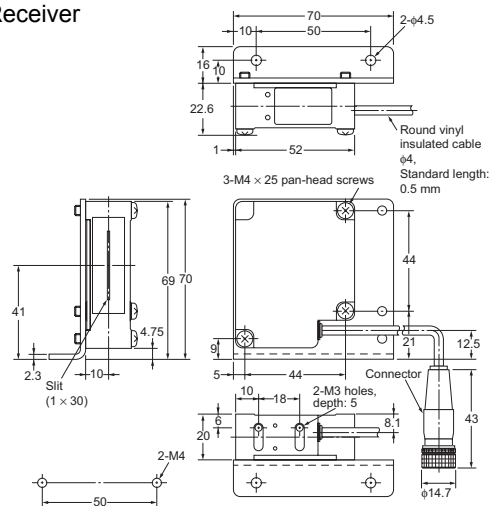

	ZX-LT001	ZX-LT005	ZX-LT010	ZX-LT030	
Applicable Amplifier Units	ZX-LDA11-N/41-N, ZX-LDA11/41				
Light source	Visible semiconductor laser (650nm, 1mW max., JIS class 1)				
Detection distance	0 to 500 mm	500 to 2,000 mm	0 to 500 mm		
Detection width	φ1 mm	φ2.5 mm	5 mm	10 mm	30 mm
Minimum sensing object	φ8 μm opaque body	φ8 to φ50 μm opaque body	φ0.05 mm opaque body	φ0.1 mm opaque body	φ0.3 mm opaque body
Resolution (*1)	4 μm (*2)	-	4 μm (*3)		12 μm (*4)
Temperature characteristic	0.2%F.S. or lower			0.3%F.S. or lower	
Operating ambient illumination	10,000 lx (incandescent light)				
Operating ambient temperature	Operating: 0 to 50°C, Storage: -25 to 70°C (with no icing or condensation)				
Operating ambient humidity	Operating and storage: 35% to 85% (with no condensation)				
Degree of protection	IP40				
Cable extension	Extendable up to 10m with a special extension cable.			-	
Weight (packed state)	Approx. 220g			Approx. 450 g	
Materials	Case: Polyetherimide Case cover: Polycarbonate Front filter: Glass			Case and case cover: Diecast zinc, Front cover: Glass	
Accessories	Optical axis adjustment seal Sensor Head - Amplifier Unit connecting cable Instruction sheet			Mounting bracket, connecting cable between Sensor Head and Amplifier Unit, Instruction sheet.	

- (\*1) Detection width converted from the fluctuation width ( $\pm 3\sigma$ ) of linear outputs when connected to Amplifier Unit
- (\*2) Measured with detection distance of 0 to 500 mm and averaging number of 64. The resolution will be 5μm if the averaging number is 32.  
Measurement is taken with assumption that light irradiating near the center of the detection width ( $-\phi 1\text{mm}$ ) is blocked by the minimum sensing object.
- (\*3) Measured with averaging number of 64. The resolution will be 5μm if the averaging number is 32.
- (\*4) Measured with averaging number of 64. The resolution will be 15μm if the averaging number is 32.

Calculating Units  
ZX-CAL2

(Unit: mm)

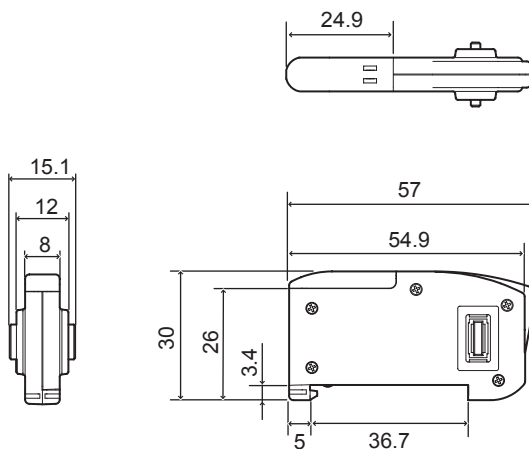

Applicable Amplifier Units	ZX Series
Current consumption	12 mA max. (supplied from the Smart Sensor Amplifier Unit)
Ambient temperature	Operating: 0 to 50°C, Storage: -15 to 60°C (with no icing or condensation)
Ambient humidity	Operating and storage: 35% to 85% (with no condensation)
Connection method	Connector
Dialectic strength	1,000 VAC, 50/60 Hz for 1 min.
Insulation resistance	100 MΩ (at 500 VDC)
Vibration resistance (destructive)	10 to 150 Hz, 0.7-mm double amplitude, 80 min each in X, Y, and Z directions
Shock resistance (destructive)	300 m/s <sup>2</sup> 3 times each in six directions (up/down, left/right, forward/backward)
Materials	Display: Acrylic, Case: ABS resin
Weight (packed state)	Approx. 50g

Interface Units  
ZX-SF11

(Unit: mm)

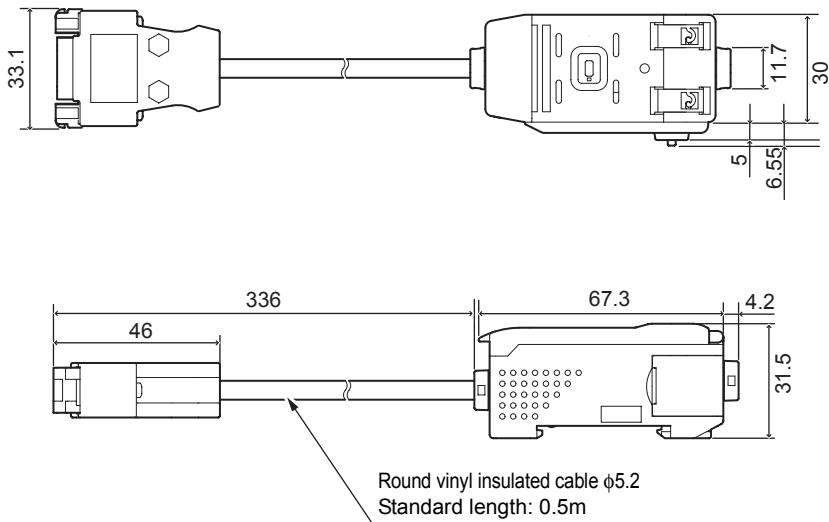

■ Connector Pin Arrangement and Connection Example with Personal Computer

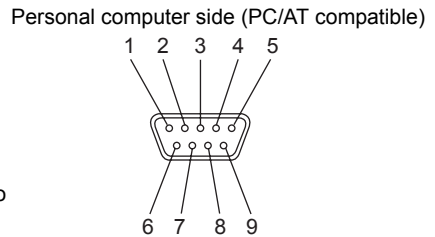
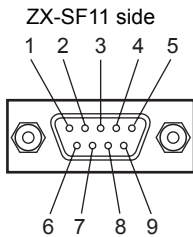

ZX-SF11 is connected to the personal computer with a 9-pin D-sub cross cable (female to female).

Pin No.	Name
1	N.C.
2	RD
3	SD
4	N.C.
5	SG
6	N.C.
7	N.C.
8	N.C.
9	N.C.

Pin No.	Name
1	CD
2	RD
3	SD
4	ER
5	SG
6	DR
7	RS
8	CS
9	CI
Connector hood	FG

\* Pin Nos. may vary with the type and model of the external device to be connected. For details, refer to the instruction manual of your programmable controller or personal computer.

Power supply voltage	12 to 24 VDC $\pm$ 10%, Ripple (p-p) 10% max. Supplied from Amplifier Unit	
Current consumption	Power supply voltage: 12 V, Current consumption: 60 mA max. (Excluding Amplifier Unit current consumption and output current.)	
Connectable Amplifier Units	ZX Series	
No. of Amplifier Units connectable	Up to 5 (Two Calculating Units max.)	
Communications functions	Communications port	RS-232C port (9-pin D-sub connector)
	Protocol	CompoWay/F
	Baud rate	38,400 bps
	Data configuration	Data bits: 8, Parity: None, Start bits: 1 Stop bits: 1, Flow control: None
Indicators	Power ON (green), Communicating with Sensor (green), Sensor communications error (red) Communicating with external terminal (green), External terminal communications error (red)	
Protection circuits	Reverse power supply wiring protection	
Ambient temperature	Operating: 0 to 50°C, Storage: -15 to 60°C (with no icing or condensation)	
Ambient humidity	Operating and storage: 35% to 85% (with no condensation)	
Dialectic strength	1,000 VAC, 50/60 Hz for 1 min	
Insulation resistance	20M $\Omega$ min. (at 500 VDC)	
Case materials	Case: PBT (polybutylene terephthalate), Cover: Polycarbonate	
Weight (packed state)	Approx. 350 g	



# Communication with the Smart Monitor is possible via the Interface Unit

This section describes how to connect Amplifier Units to the personal computer using an interface unit (ZX-SF11) to enable use of Smart Monitor (ZX-SW11).

**1.** Install the Smart Monitor to the personal computer.

**2.** Check that the current/voltage switch on the base of the Interface Unit is set to the side that has no tab (default).

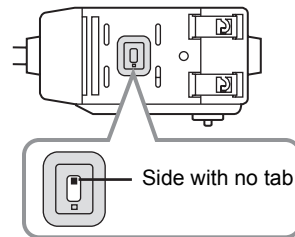

**3.** Set the Amplifier Unit to RUN mode.

 Switching Modes p.34

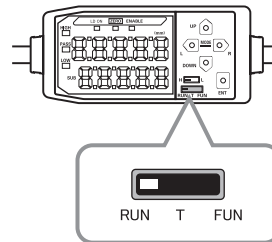

**4.** Connect the Interface Unit and personal computer with a cable.

To connect them, use a 9-pin D-sub cross cable (female to female).

 p.142

**5.** Connect the Interface Unit to the Amplifier Unit.

Use of a calculation unit (ZX-CAL2) allows connection of up to five Amplifier Units.

 If you want to connect Amplifier Units of different types, such as ZX-LDA11-N/41-N and ZX-E series, contact your OMRON representative.

 **CHECK!** Connection Method p.26

## 6. Turn ON the power supply to the Amplifier Unit.

When the Amplifier Unit is powered ON, the Interface Unit will also be powered ON.

When the ERR indicators for the Interface Unit's sensor communication indicator and external terminal communication indicator go out, communication will be ready. (Step 7)

If the ERR indicators do not go out even though five seconds or more have elapsed after the power is turned ON, the connections have not been recognized correctly, so observe the following points and then turn ON the power to the Amplifier Unit again.

- Is the switch on the Amplifier Unit set to "RUN"? (Step 3)
- Are connections between the Amplifier Units as well as between Amplifier Units and Interface Unit correct? (Steps 4, 5)
- Have the Amplifier Units started up correctly? (If they have not started up correctly due to connection failure between Amplifier Units and Sensor Head, eliminate the cause.)

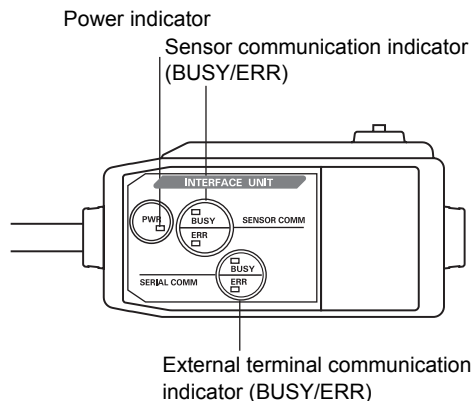

## 7. Start the Smart Monitor.

Communications will start automatically.

If communications do not start, turn OFF the power to the Interface Unit and Amplifier Units, and repeat steps from step 6.

If communications still do not start, check the following points (i) to (iii), and then restart the Smart Monitor.

- A communication port No. different from that on the personal computer is used or the communication port is used by another application program.
  - Set the same communication port No. as that on the personal computer (the other communication conditions will be set automatically).
  - Exit the application program that is using the communication port.
- The BUSY external terminal communication indicator does not light up when Smart Monitor is started (no signal is sent to the Interface Unit).
  - Is the Smart Monitor connected with the correct cable? (Check whether it is connected with a straight cable by mistake) (step 4)
  - Are the connections normal? (Steps 4, 5)
  - Is the correct communication port set?
- The BUSY external terminal communication indicator lights up for a moment when a command is transmitted, but there is no response from the Interface Unit.
  - Is the switch on the bottom of the Interface Unit set to the default side? (Step 2)
  - Is the Amplifier Unit set to RUN mode? (Step 3)

# Engineering Data

## Angle Characteristic Reflective Type Sensor Head

The angle characteristic plots the relation between the inclination of the measurement object and the error in the linear output at the measurement point.

**Note:** SUS304 = Stainless steel SUS304

### ■ ZX-LD40

Side-to-side Inclination

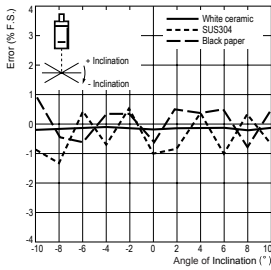

### ■ ZX-LD100

Side-to-side Inclination

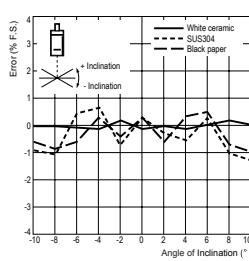

### ■ ZX-LD300

Side-to-side Inclination

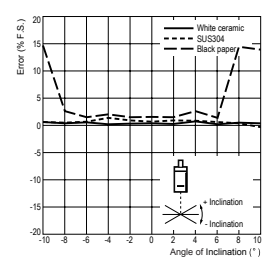

Front-to-back Inclination

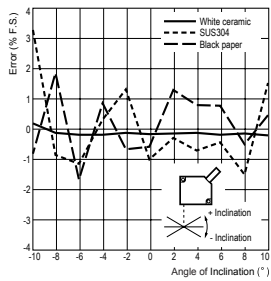

Front-to-back Inclination

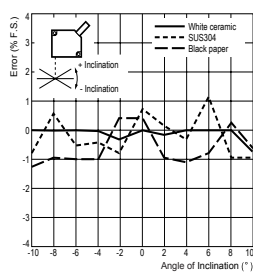

Front-to-back Inclination

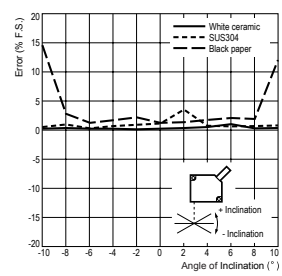

### ■ ZX-LD40L

Side-to-side Inclination

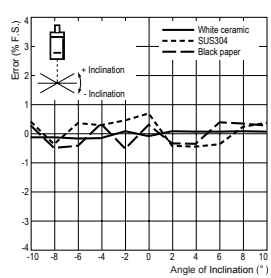

### ■ ZX-LD100L

Side-to-side Inclination

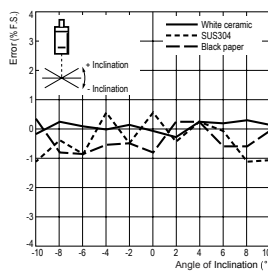

### ■ ZX-LD300L

Side-to-side Inclination

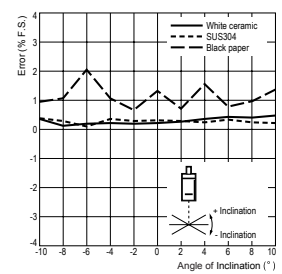

Front-to-back Inclination

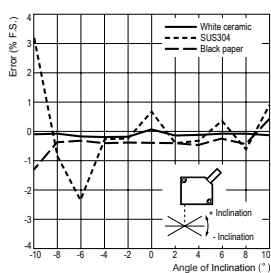

Front-to-back Inclination

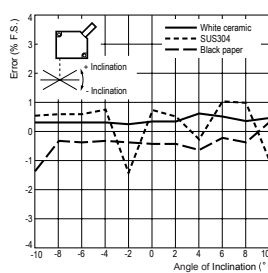

Front-to-back Inclination

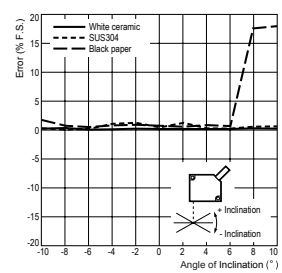

■ ZX-LD30V

Side-to-side Inclination

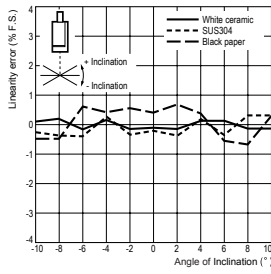

■ ZX-30VL

Side-to-side Inclination

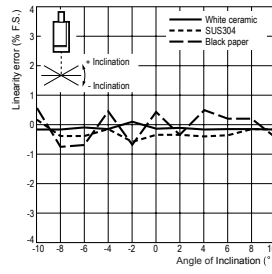

Front-to-back Inclination

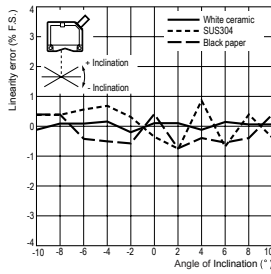

Front-to-back Inclination

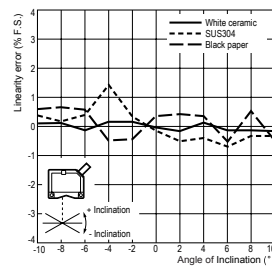

# Linearity Characteristic for Different Materials (Reflective Type Sensor Head)

## ■ ZX-LD40

0° Inclination

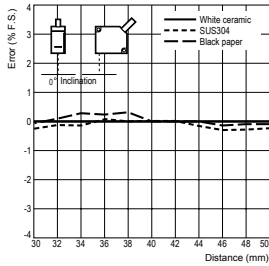

-10° Inclination Front-to-back

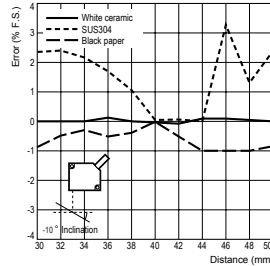

10° Inclination

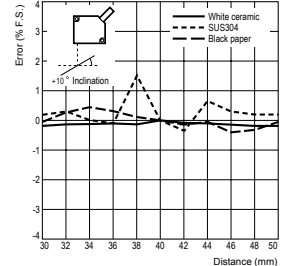

## ■ ZX-LD100

0° Inclination

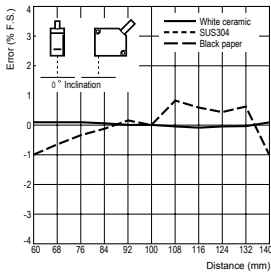

-10° Inclination Front-to-back

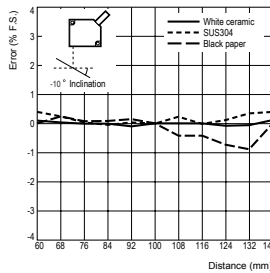

10° Inclination

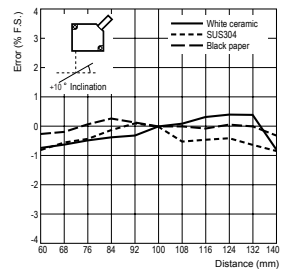

## ■ ZX-LD300

0° Inclination

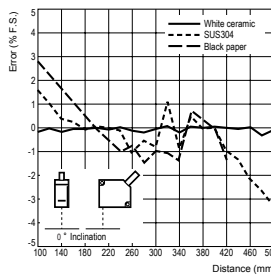

-10° Inclination Front-to-back

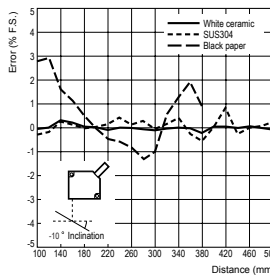

10° Inclination

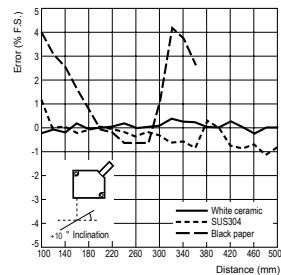

## ■ ZX-LD40L

0° Inclination

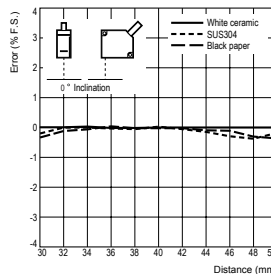

-10° Inclination Front-to-back

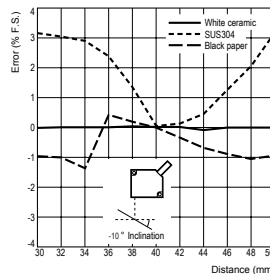

10° Inclination

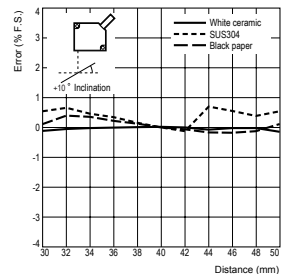

**■ ZX-LD100L**

0° Inclination

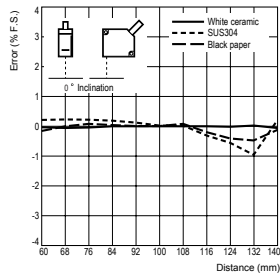

-10° Inclination Front-to-back

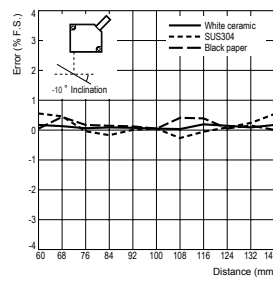

10° Inclination

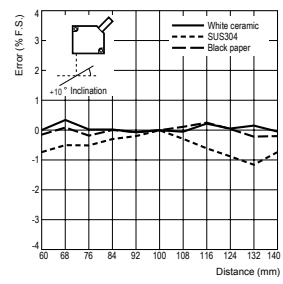

**■ ZX-LD300L**

0° Inclination

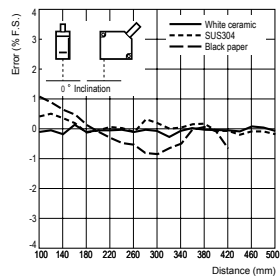

-10° Inclination Front-to-back

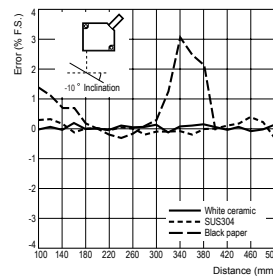

10° Inclination

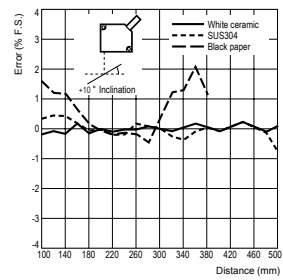

**■ ZX-LD30V**

0° Inclination

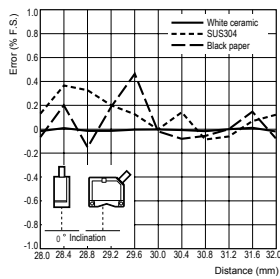

-10° Inclination Front-to-back

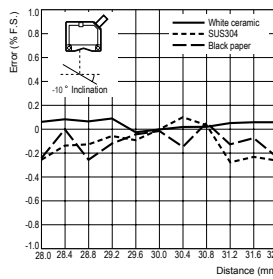

10° Inclination

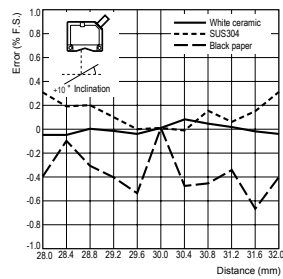

**■ ZX-LD30VL**

0° Inclination

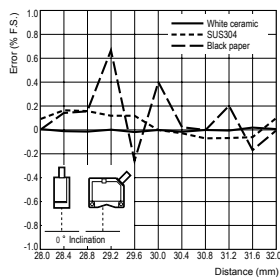

-10° Inclination Front-to-back

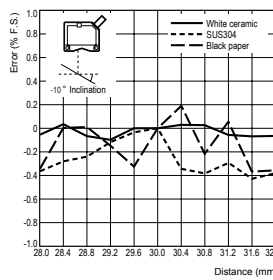

10° Inclination

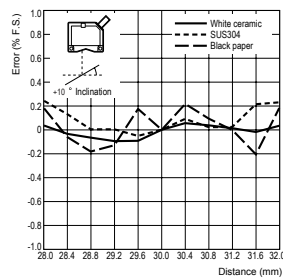

## Spot Diameter Reflective Sensor Type Sensor Head

### ■ Spot Beam Type

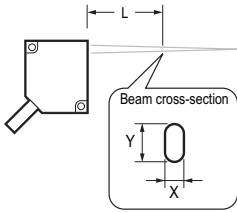

ZX-LD40

L	30mm	40mm	50mm
X	240μm	40.0μm	250μm
Y	350μm	30.0μm	370μm

ZX-LD100

L	60mm	100mm	140mm
X	390μm	100μm	430μm
Y	620μm	65.0μm	650μm

ZX-LD300

L	100mm	300mm	500mm
X	1,050μm	180μm	1,100μm
Y	450μm	300μm	850μm

### ■ Spot Beam Type

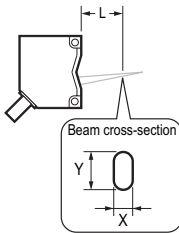

ZX-LD30V

L	28mm	30mm	32mm
X	60.0μm	30.0μm	120μm
Y	50.0μm	40.0μm	90.0μm

### ■ Line Beam Type

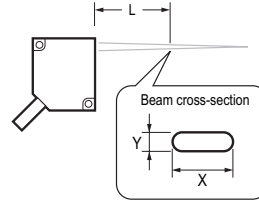

ZX-LD40L

L	30mm	40mm	50mm
X	2,000μm	2,000μm	2,000μm
Y	240μm	50.0μm	250μm

ZX-LD100L

L	60mm	100mm	140mm
X	2,000μm	2,000μm	2,000μm
Y	410μm	100μm	430μm

ZX-LD300L

L	100mm	300mm	500mm
X	2,000μm	2,000μm	2,500μm
Y	750μm	300μm	650μm

### ■ Line Beam Type

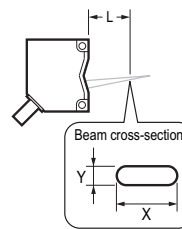

ZX-30VL

L	28mm	30mm	32mm
X	1,800μm	1,800μm	1,800μm
Y	90.0μm	60.0μm	110μm

## Sensing Object Characteristic (Through-beam Type Sensor Head)

### ZX-LT001

(For 0.02-mm-dia. pin gauge)

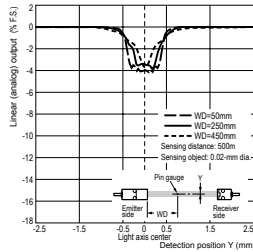

(For 0.05-mm-dia. pin gauge)

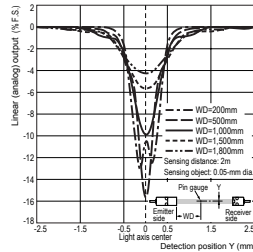

### ZX-LT005

(For 0.05-mm-dia. pin gauge)

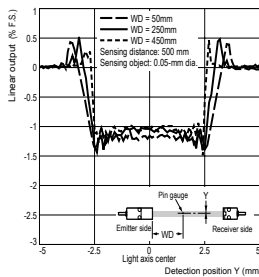

### ZX-LT010

(For 0.1-mm-dia. pin gauge)

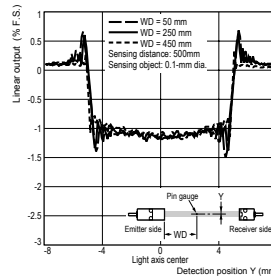

## Linearity Characteristic (Through-beam Type Sensor Head)

### ZX-LT005

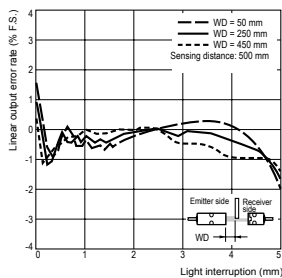

### ZX-LT010

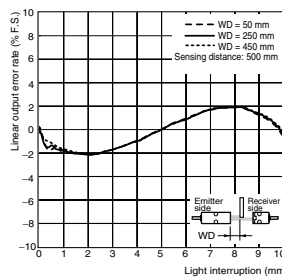



# Quick Reference for Displays

Using the Quick Reference

Items in the Display column marked with an asterisk (\*) appear on the sub-display. All other items appear on the main display.

Display		Details		Pages
1	1-Sht (*)	1-SHT	Timer/One-shot timer	p.104
A	A20A	A20mA	The meaning of this display item depends on the selected functions. Monitor focus/First point setting (for current output) Linear output correction/First point offset (for current output)	p.95 p.99
	A 4V	A 4V	The meaning of this display item depends on the selected functions. Monitor focus/First point setting (for voltage output) Linear output correction/First point offset (for voltage output)	p.95 p.99
	A-b (*)	A-B	2-sensor operation/A-B	p.108
	A Ib (*)	AIB	2-sensor operation/A+B	p.108
	ALL (*)	ALL	Displays all of the special menu.	p.39
	AUTO (*)	AUTO	Gain change/auto gain	p.74
	AUTO5	AUTOS	Auto scale setting (When Through-beam type sensor head is connected)	p.42
	AUTOt	AUTOT	T mode/Executing automatic teaching	p.92
	AVE	AVE	Number of samples to average setting	p.66
	AVE-h (*)	AVE-H	Hold/Average hold	p.76
B	b 4A	B 4mA	The meaning of this display item depends on the selected functions. Monitor focus/Second point setting (for current output) Linear output correction/Second point offset (for current output)	p.95 p.99
	b 4V	B 4V	The meaning of this display item depends on the selected functions. Monitor focus/Second point setting (for voltage output) Linear output correction/Second point offset (for voltage output)	p.95 p.99
	b-h (*)	B-H	Hold/Bottom hold	p.76
	BLACK (*)	BLACK	Gain change/Black	p.74
C	cALC	CALC	Calculation setting for adjacent Sensors	p.108
	cLAMP	CLAMP	Clamp value setting for non-measurement	p.102
	cLAMP (*)	CLAMP	Non-measurement setting/Return output to clamp value	p.102
	cLOSE (*)	CLOSE	Hides the special menu.	p.39
	comp	COMP	Previous value comparison function	p.86

Display		Details		Pages
D	d-cyc	D-CYC	Differentiation function/Differentiation cycle count	p.83
	d-fwd (*)	D-FWD	Display direction for measured values when scaling function used (display not inverted)	p.67
	d-inv (*)	D-INV	Display direction for measured values when scaling function used (display inverted)	p.67
	d-iff	DIFF	Differentiation function	p.83
	d-digit	DIGIT	Number of digits setting for main and sub-displays	p.112
	d-down (*)	DOWN	Hold/Trigger mode/Self-down trigger	p.78
	d-rev	DREV	Reverses position of main and sub-displays.	p.113
d-disp (*)	DISP	Displays display-related functions from special menu.	p.39	
E	eco	ECO	Reduces power consumption by reducing main and sub-display lighting.	p.115
	etc (*)	ETC	Displays functions other than display- and output-related functions from special menu.	p.39
F	focus	FOCUS	Measured value output range setting	p.95
G	gain	GAIN	Gain switching function	p.74
H	h-dly	H-DLY	Hold/Delay hold	p.81
	h-d-t	H-D-T	Hold/Delay hold/Delay time setting	p.81
	h-hys	H-HYS	Hold/Trigger mode/Self-trigger hysteresis width setting.	p.78
	h-lvl	H-LVL	Hold/Trigger mode/Self-trigger level setting.	p.78
	h-s-t	H-S-T	Hold/Delay hold/Sampling period setting	p.81
	h-trg	H-TRG	Hold/Trigger mode setting	p.78
	hold	HOLD	Hold setting	p.76
hys	HYS	Hysteresis width setting	p.94	
I	init	INIT	Initialization of settings	p.123
	intn	INTN	Intensity mode (When Reflective type sensor head is connected)	p.46
K	keep (*)	KEEP	Non-measurement settings/Hold output	p.102
L	l-adj	L-ADJ	Linear output offset value setting	p.99
M	max (*)	MAX	Non-measurement settings/Clamp value/Maximum	p.102
	metal (*)	METAL	Gain change/Metal	p.74
	mirror (*)	MIRROR	Gain change/Mirror	p.74
O	off-d (*)	OFF-D	Timer/Off-delay	p.104
	on-d (*)	ON-D	Timer/On-delay	p.104

Display		Details		Pages
P	P1SCL (*)	P1SCL	Scaling/First-point scaling	p.67
	P2SCL (*)	P2SCL	Scaling/Second-point scaling	p.67
	P-h (*)	P-H	Hold/Peak hold	p.76
	PP-h (*)	PP-H	Hold/Peak-to-peak hold	p.76
R	rESEt	RESET	Output settings for non-measurement	p.102
	rESEt (*)	RESET	RUN or T mode/Resetting input	p.27
S	S-h (*)	S-H	Hold/Sample hold	p.76
	ScALE	SCALE	Scaling setting	p.67
	SEt (*)	SET	Displays output-related functions from special menu	p.39
	SEtSt (*)	SETST	Standard received light amount setting (When Through-beam type sensor head is connected)	p.45
	SPcL	SPCL	Special menu Displays scaling, monitor focus, and other special functions.	p.39
T	t-t iā	T-TIM	Timer time	p.104
	tH iCk	THICK	2-sensor operation/Thickness setting	p.108
	t iāEr	TIMER	Judgement output timing setting	p.104
	t iā iG (*)	TIMIG	The meaning of this display item depends on the selected mode. FUN mode: Hold/Trigger mode/Timing input RUN or T modes: Input timing	p.78 p.27
U	UP (*)	UP	Hold/Trigger mode/Self-up trigger	p.78
W	Wh iTE (*)	WHITE	Gain change/White	p.74
Z	ZrDSP	ZRDSP	Offset value input for zero reset	p.116
	ZrāErā	ZRMEM	Setting to save or clear measured values at zero reset	p.120

# Requirements from Regulations and Standards

## 1. Summary of Requirements to Manufactures

### 1-1 For Europe

EN 60825-1 “Safety of Laser Products, Equipment Classification, Requirements and User’s Guide”  
Summary of Manufacturer’s Requirements

Requirements subclause	Classification						
	Class 1	Class 1M	Class 2	Class 2M	Class 3R	Class 3B	Class 4
<b>Description of hazard class</b>	Safe under reasonably foreseeable conditions	As for Class 1 except may be hazardous if user employs optics	Low power; eye protection normally afforded by aversion responses	As for Class 2 except may be more hazardous if user employs optics	Direct intra-beam viewing may be hazardous	Direct intra-beam viewing normally hazardous	High power; diffuse reflections may be hazardous
<b>Protective housing</b>	Required for each laser product; limits access necessary for performance of functions of the products						
<b>Safety interlock in protective housing</b>	Designed to prevent removal of the panel until accessible emission values are below that for Class 3R				Designed to prevent removal of the panel until accessible emission values are below that for Class 3B		
<b>Remote control</b>	Not required					Permits easy addition of external interlock in laser installation	
<b>Key control</b>	Not required					Laser inoperative when key is removed	
<b>Emission warning device</b>	Not required				Give audible or visible warning when laser is switched on or if capacitor bank of pulsed laser is being charged. For Class 3R only, applies invisible radiation is emitted		
<b>Attenuator</b>	Not required					Give means beside the On/Off switch to temporarily to block beam	
<b>Location controls</b>	Not required				Controls so located that there is no danger of exposure to AEL above Classes 1 or 2 when adjustments are made		
<b>Viewing optics</b>	Not required	Emission from all viewing systems must be below Class 1M AEL					
<b>Scanning</b>	Scan failure shall not cause product to exceed its classification						
<b>Class label</b>	Required wording		Figures A required wording				
<b>Aperture label</b>	Not required				Specified wording required		
<b>Service entry label</b>	Required as appropriate to the class of accessible radiation						
<b>Override interlock label</b>	Required under certain conditions as appropriate to the class of laser used						
<b>Wavelength range label</b>	Required for certain wavelength ranges						
<b>LED label</b>	Make required word substitutions for LED products						

Requirements subclause	Classification						
	Class 1	Class 1M	Class 2	Class 2M	Class 3R	Class 3B	Class 4
User information	Operation manuals must contain instructions for safe use. Additional requirements apply for Class 1M and Class 2M						
Purchasing and service information	Promotion brochures must specify product classification; service manuals must contain safety information						

- Note:** 1. This table is intended to provide a convenient summary of requirements. See text of this standard for complete requirements.
2. For the safety medical laser products, IEC 60601-2-22 applies
3. AEL: Accessible Emission Limit  
The maximum accessible emission level permitted within a particular class. For your reference, see ANSI Z136.1-1993, Section 2.

Symbol and border: black  
Background: yellow

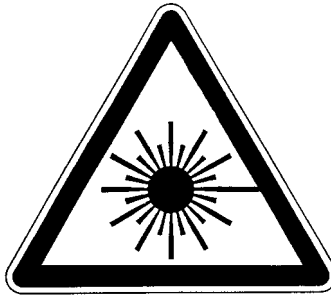

Figure A Warning label - Hazard symbol

## 1-2 For U.S.A

FDA (Compliance Guide for Laser Products, 1985, according to 21 CFR1040.10)

Requirements	Class (see note 1)					
	I	Ila	II	IIIa	IIIb	IV
<b>Performance (all laser products)</b>						
Protective housing	R (see note 2)	R (see note 2)	R (see note 2)	R (see note 2)	R (see note 2)	R (see note 2)
Safety interlock	R (see notes 3,4)	R (see notes 3,4)	R (see notes 3,4)	R (see notes 3,4)	R (see notes 3,4)	R (see notes 3,4)
Location of controls	N/A	R	R		R	R
Viewing optics	R	R	R	R	R	R
Scanning safeguard	R	R	R	R	R	R
<b>Performance (laser systems)</b>						
Remote control connector	N/A	N/A	N/A	N/A	R	R
Key control	N/A	N/A	N/A	N/A	R	R
Emission indicator	N/A	N/A	R	R	R (see note 10)	R (see note 10)
Beam attenuator	N/A	N/A	R	R	R	R
Reset	N/A	N/A	N/A	N/A	N/A	R (see note 13)
<b>Performance (specific purpose products)</b>						
Medical	S	S	S	S (see note 8)	S (see note 8)	S (see note 8)
Surveying, leveling, alignment	S	S	S	S	NP	NP
Demonstration	S	S	S	S	S (see note 11)	(see note 11)
<b>Labeling (all laser products)</b>						
Certification & identification	R	R	R	R	R	R
Protective housing	D (see note 5)	D (see note 5)	D (see note 5)	D (see note 5)	D (see note 5)	D (see note 5)
Aperture	N/A	N/A	R	R	R	R
Class warning	N/A	R (see note 6)	R (see note 7)	R (see note 9)	R (see note 12)	R (see note 12)
<b>Information (all laser products)</b>						
User information	R	R	R	R	R	R
Product literature	N/A	R	R	R	R	R
Service information	R	R	R	R	R	R

### Abbreviations:

**R:** Required.

**N/A:** Not applicable.

**S:** Requirements: Same as for other products of that Class. Also see footnotes.

**NP:** Not permitted.

**D:** Depends on level of interior radiation.

### Footnotes:

**Note 1:** Based on highest level accessible during operation.

**Note 2:** Required wherever & whenever human access to laser radiation above Class I limits is not needed for product to perform its function.

**Note 3:** Required for protective housings opened during operation or maintenance, if human access thus gained is not always necessary when housing is open.

**Note 4:** Interlock requirements vary according to Class of internal radiation.

**Note 5:** Wording depends on level & wavelength of laser radiation within protective housing.

**Note 6:** Warning statement label.

**Note 7:** CAUTION logotype.

**Note 8:** Requires means to measure level of laser radiation intended to irradiate the body.

**Note 9:** CAUTION if  $2.5 \text{ mW cm}^2$  or less, DANGER if greater than  $2.5 \text{ mW cm}^2$ .

**Note 10:** Delay required between indication & emission.

**Note 11:** Variance required for Class IIb or IV demonstration laser products and light shows.

**Note 12:** DANGER logotype.

**Note 13:** Required after August 20, 1986.

## 2. Summary of Requirements to User

### 2-1 For Europe

EN 60825-1

Requirements subclause	Classification						
	Class 1	Class 1M	Class 2	Class 2M	Class 3R	Class 3B	Class 4
Laser safety officer	Not required but recommended for applications that involve direct viewing of the laser beam				Not required for visible emission Required for non-visible emission	Required	
Remote interlock	Not required					Connect to room or door circuits	
Key control	Not required					Remove key when not in use	
Beam attenuator	Not required					When in use prevents inadvertent exposure	
Emission indicator device	Not required				Indicates laser is energized for non-visible wavelengths	Indicates laser is energized	
Warning signs	Not required					Follow precautions on warning signs	
Beam path	Not required	Class 1M as for Class 3B (see note 2)	Not required	Class 2M as for Class 3B (see note 3)	Terminate beam at end of useful length		
Specular reflection	No requirements	Class 1M as for Class 3B (see note 2)	No requirements	Class 2M as for Class 3B (see note 3)	Prevent unintentional reflections		
Eye protection	No requirements				Not required for visible emission Required for non-visible emission	Required if engineering and administrative procedures not practicable and MPE exceeded	
Protective clothing	No requirements					Sometimes required	Specific requirements
Training	No requirements	Class 1M as for Class 3R (see note 2)	No requirements	Class 2M as for Class 3R (see note 3)	Required for all operator and maintenance personnel		

**Note:** 1. This table is intended to provide a convenient summary of requirements. See text of this standard for complete precautions.

2. Class 1M laser products that failed condition 1 of table 10 of the standard. Not required for Class 1M laser products that failed condition 2 of table 10 of the standard. See the text for details.

3. Class 2M laser products that failed condition 1 of table 10 of the standard. Not required for Class 2M laser products that failed condition 2 of table 10 of the standard. See the text for details.



## 2-2 For U.S.A

### ANSI Z136.1:1993 “American National Standard for the Safe Use of Lasers” Control Measures for the Four Laser Classes

Control measures	Classification					
	1	2a	2	3a	3b	4
Engineering Controls	1	2a	2	3a	3b	4
Protective Housing(4.3.1)	X	X	X	X	X	X
Without Protective Housing (4.3.1.1)	LSO (see note 2) shall establish Alternate Controls					
Interlocks on Protective Housing (4.3.2)	☆	☆	☆	☆	X	X
Service Access Panel(4.3.3)	☆	☆	☆	☆	X	X
Key Control(4.3.4)	---	---	---	---	•	X
Viewing Portals(4.3.5.1)	---	---	MPE	MPE	MPE	MPE
Collecting Optics(4.3.5.2)	MPE	MPE	MPE	MPE	MPE	MPE
Totally Open Beam Path(4.3.6.1)	---	---	---	---	X NHZ	X NHZ
Limited Open Beam Path(4.3.6.2)	---	---	---	---	X NHZ	X NHZ
Enclosed Beam Path(4.3.6.3)	None is required if 4.3.1 and 4.3.2 fulfilled					
Remote Interlock Connector(4.3.7)	---	---	---	---	•	X
Beam Stop or Attenuator(4.3.8)	---	---	---	---	•	X
Activation Warning Systems(4.3.9)	---	---	---	---	•	X
Emission Delay(4.3.9.1)	---	---	---	---	---	X
Indoor Laser Controlled Area(4.3.10)	---	---	---	---	X NHZ	X NHZ
Class 3b Laser Controlled Area (4.3.10.1)	---	---	---	---	X	---
Class 4 Laser Controlled Area (4.3.10.2)	---	---	---	---	---	X
Laser Outdoor Controls(4.3.11)	---	---	---	---	X NHZ	X NHZ
Laser in Navigable Airspace (4.3.11.2)	---	---	---	•	•	•
Temporary Laser Controlled Area (4.3.12)	☆ MPE	☆ MPE	☆ MPE	☆ MPE	---	---
Remote Firing & Monitoring (4.3.13)	---	---	---	---	---	•
Labels (4.3.14 and 4.7)	X	X	X	X	X	X
Area Posting(4.3.15)	---	---	---	•	X NHZ	X NHZ
Administrative & Procedural Controls	1	2a	2	3a	3b	4
Standard Operating Procedures(4.4.1)	---	---	---	---	•	X
Output Emission Limitations(4.4.2)	---	---	---	LSO Determination		
Education and Training(4.4.3)	---	---	•	•	X	X
Authorized Personnel(4.4.4)	---	---	---	---	X	X
Alignment Procedures(4.4.5)	---	---	X	X	X	X
Protective Equipment(4.4.6)	---	---	---	---	•	X
Spectator(4.4.7)	---	---	---	---	•	X
Service Personnel(4.4.8)	☆ MPE	☆ MPE	☆ MPE	☆ MPE	X	X
Demonstration with General Public(4.5.1)	MPE+	---	X	X	X	X
Laser Optical Fiber Systems(4.5.2)	MPE	MPE	MPE	MPE	X	X

Control measures	Classification					
Laser Robotic Installations(4.5.3)	---	---	---	---	X NHZ	X NHZ
Eye Protection(4.6.2)	---	---	---	---	• MPE	X MPE
Protective Windows(4.6.3)	---	---	---	---	X NHZ	X NHZ
Protective Barriers and Curtains(4.6.4)	---	---	---	---	•	•
Skin Protection(4.6.5)	---	---	---	---	X MPE	X MPE
Other Protective Equipment(4.6.5)	Use may be required					
Warning Signs and Labels(4.7) (Design Requirements)	---	---	•	•	X NHZ	X NHZ
Service and Repairs(4.8)	LSO Determination					
Modification of Laser Systems(4.9)	LSO Determination					

**Note:** 1.LEGEND

- X: Shall
- : Should
- : No requirement
- ☆ : Shall if enclosed Class 3b or Class 4
- MPE: Shall if MPE is exceeded
- NHZ: Nominal Hazard Zone analysis required
- +: Applicable only to UV and IR Lasers(4.5.1.2)

## 2.LSO: Laser Safety Officer

An individual shall be designated the Laser Safety Officer with the authority and responsibility to monitor and enforce the control of laser hazards, and to effect the knowledgeable evaluation and control of laser hazards. For your reference, see ANSI Z136.1993, Section 1.3.

## 3. Definitions of Laser Classification

### 3-1 For Europe

#### Laser Product Classifications

EN

Class	Description
<b>Class 1</b>	Lasers which are safe under reasonably foreseeable conditions of operation.
<b>Class 2</b>	Lasers emitting visible radiation in the wavelength range from 400 nm to 700 nm. Eye protection is normally afforded by aversion responses including the blink reflex.
<b>Class 3A</b>	Lasers which are safe for viewing with the unaided eye. For laser emitting in the wavelength range from 400 nm to 700 nm, protection is afforded by aversion responses including the blink reflex. For other wavelengths the hazard to the unaided eye is no greater than for Class 1. Direct intrabeam viewing of Class 3A lasers with optical aides (e.g., binoculars, telescopes, microscopes) may be hazardous.
<b>Class 3B</b>	Direct intrabeam viewing of these lasers is always hazardous. Viewing diffuse reflections is normally safe (see note).
<b>Class 4</b>	Lasers which are also capable of producing hazardous diffuse reflections. They may cause skin injuries and could also constitute a fire hazard. Their use requires extreme caution.

**Note:** Conditions for safe viewing of diffuse reflections for Class 3B visible lasers are: minimum viewing distance of 13 cm between screen and cornea and a maximum viewing time of 10 s. Other viewing conditions require a comparison of the diffuse reflection exposure with the MPE.

### 3-2 For U.S.A

#### Comparison of Classifications between FDA and ANSI

Class	FDA definition	ANSI description
<b>Class I/1</b>	Limits applicable to devices that have emissions in the ultraviolet, visible, and infrared spectra, and limits below which biological hazards have not been established.	A Class 1 laser is considered to be incapable of producing damaging radiation levels during operation and maintenance and is, therefore, exempt from any control measures or other forms of surveillance.
<b>Class IIa/2a</b>	Limits applicable to products whose visible emission does not exceed Class I limits for emission durations of 1,000 seconds or less and are not intended for viewing.	Class 2 lasers are divided into two subclasses, 2 and 2a. A Class 2 laser emits in the visible portion of the spectrum (0.4 to 0.7 $\mu\text{m}$ ) and eye protection is normally afforded by the aversion response including the blink reflex.
<b>Class II/2</b>	Limits applicable to products that have emissions in the visible spectrum (400 to 710 nm) for emission durations in excess of 0.25 second, providing that emissions for other durations and/or wavelengths do not exceed the Class I limits. Class II products are considered hazardous for direct long-term ocular exposure.	

Class	FDA definition	ANSI description
<b>Class IIIa/3a</b>	Limits to products that have emissions in the visible spectrum and that have beams where the total collectable radiant power does not exceed 5 milliwatts.	
<b>Class IIIb/3b</b>	Limits applicable to devices that emit in the ultraviolet, visible, and infrared spectra. Class IIIb products include laser systems ranging from 5 to 500 milliwatts in the visible spectrum. Class IIIb emission levels are ocular hazards for direct exposure throughout the range of the Class, and skin hazards at the higher levels of the Class.	Class 3 lasers are divided into two sub-classes, 3a and 3b. A Class 3 laser may be hazardous under direct and specular reflection viewing conditions, but the diffuse reflection is usually not a hazard.
<b>Class IV/4</b>	Exceeding the limits of Class IIIb and are a hazard for scattered reflection as well as for direct exposure.	A Class 4 laser is a hazard to the eye or skin from the direct beam and sometimes from a diffuse reflection and also can be a fire hazard. Class 4 lasers may also produce laser-generated air contaminants and hazardous plasma radiation.

# Index

<b>A</b>		Error messages	127
Adjusting the Optical Axis	20	<b>F</b>	
alphabet display format	36	Flow of Operation	32
Amplifier Unit		FUN Mode	
Dimensions	132	Display Contents	35
Installing	16	Function transitions	40
Part names	11	Outline	34
Specifications	132	Function Transition Charts	39
Angle Characteristic	146	<b>G</b>	
Automatic teaching	92	Glossary	130
Average hold	77	GND wire	27
<b>B</b>		<b>H</b>	
Basic Configuration	10	HIGH judgement output wire	27
Bottom hold	76	Hold	
<b>C</b>		Mode selection	76
Cable extension	5	Selecting conditions	76
Calculating Unit		Hold Functions	76
Connecting	24	Hysteresis width	78, 94
Part names	14	<b>I</b>	
Specifications and Dimensions	141	I/O Circuit Diagrams	28
Changing display brightness	115	Initialization	
Changing Display Scales	67	Settings data	123
Changing the Number of Display Digits	112	Initializing settings data	123
channel numbers	25	Intensity mode	46
Characteristic Data	146	Interface Unit	
Circuit Diagram		Communication with the smart monitor	144
NPN Amplifier Unit	28	Connecting	26
PNP Amplifier Unit	29	Connector pin arrangement	142
CLAMP	102	Dimensions	142
CLAMP value	102	Example with Personal Computer	142
Communication with the smart monitor	144	Part names	15
Correcting Output Values	99	Specifications	143
Current/voltage switch	11	<b>J</b>	
Cursor Keys	36	Judgement output timing	104
<b>D</b>		<b>K</b>	
Default value		KEEP	102
Settings data	123	Key lock	
Delay hold	81	Releasing	122
Detection width	140	Setting	122
Differentiation function	83	Key lock function	122
Direct input	89	key operations	36
Display reverse	113	<b>L</b>	
<b>E</b>		Laser indicator	11
ECO mode	115	Laser Life Monitor	7
ENABLE indicator	11		



---

**T**

T Mode	
Display Contents	35
Function transitions	39
Outline	34
Teaching	88
Threshold	
Automatic teaching	92
Direct input	89
Entering	88
Position teaching	90
Switch	11
Two-point teaching	91
Through-beam Type Sensor Head	
Connecting	21
Timer	104
Timing	
Input	78
Input wire	27
Tolerance	
Displaying	116
Setting offset values	117
Transmission Type Sensor Head	
Dimensions	138, 139
Installing	19
Part names	13
Specifications	140
Trigger mode selection	78
Troubleshooting	126
Two-point scaling	72
Two-point teaching	91

---

**W**

Wiring	27
--------	----

---

**Z**

Zero reset	116
Executing	118
Indicator	11
Input wire	27
memory	120
Releasing	119
Setting offset values for	117

MEMO



# Revision History

---

A manual revision code appears as a suffix to the catalog number at the bottom of the front and back covers of this manual.

Cat. No. Z197-E1-02A

↑  
Revision code

Revision code	Date	Revised contents
01	Dec. 2003	Original production
02	July 2006	Pages ii to iv: Information replaced. Page 127: Three rows added to table and note added after table. Page 133: Linearity specification changed for ZX-LD40L. Pages 136 and 137: Graphic moved and another one added. Page 138: Column added.
02A	March 2007	Page 159: Changed classification under class 3R for eye protection.

**OMRON Corporation**  
**Industrial Automation Company**

**Sensing Devices Division H.Q.**  
**Application Sensors Division**  
Shiokoji Horikawa, Shimogyo-ku,  
Kyoto, 600-8530 Japan  
Tel: (81)75-344-7068/Fax: (81)75-344-7107

***Regional Headquarters***

**OMRON EUROPE B.V.**  
Sensor Business Unit,  
Carl-Benz-Str. 4, D-71154 Nufringen,  
Germany  
Tel: (49)7032-811-0/Fax: (49)7032-811-199

**OMRON ELECTRONICS LLC**  
1 East Commerce Drive, Schaumburg, IL 60173  
U.S.A.  
Tel: (1)847-843-7900/Fax: (1)847-843-8568

**OMRON ASIA PACIFIC PTE. LTD.**  
83 Clemenceau Avenue,  
#11-01, UE Square,  
239920 Singapore  
Tel: (65)6835-3011/Fax: (65)6835-2711

**OMRON (CHINA) CO., LTD.**  
Room 2211, Bank of China Tower,  
200 Yin Cheng Road (M),  
Shanghai, 200120 China  
Tel: (86)21-5037-2222/Fax: (86)21-5037-2200

**Authorized Distributor:**