

The OMRON logo is displayed in a bold, blue, sans-serif font. The letters are thick and rounded, with the 'O' being a simple circle. The entire logo is set against a light yellow rectangular background.

Automatización Eléctrica
Especialistas en Automatización

At the end of this document you will find links to products related to this catalog. You can go directly to our shop by clicking [HERE](#). [HERE](#)

Fiber optic sensors

E32/E3X

- wide portfolio range of fiber sensing heads
- application oriented design for long operational lifetime
- high precision in design and manufacturing for high application accuracy
- fiber and amplifier designs for easy installation and set up



Features



Long operational lifetime

Ensuring that the sensors do not fail during production and require only minimal service attention enhances productivity and reduces maintenance costs.

1. **Models with enhanced protection and tested resistance against harsh environments**
 - Tested resistance against aggressive chemicals, extreme temperatures, low pressure (vacuum), mechanical abuse

2. **Preventing fiber breakage**

- Housing construction preventing protruding cables (e.g. square shape, side view models)
- High flex fibers with 1mm bending radius for close wall mounting
- Robot fibers tested with more than one million bending cycles
- Protective metal or plastic tubes

3. **Operational stability**

- LED power control against aging effects
- Auto-threshold control for enhanced compensation of power decrease, e.g. through dirt on lenses



Easy to set up and adjust

With minimal time required for mounting the fibers the productivity can be enhanced for machine builders and the easy setting of the amplifiers simplifies production changes for machine users.

1. **Easy-teach amplifiers or manual adjusters**
 - Easy manual adjustment by potentiometer
 - One-button auto teach for in-process dynamic teaching, or two-point object teaching

2. **Wide range of easy-to-mount fibers**

- One-screw-mount fibers with hexagonal back
- Square shapes for simple surface mounting
- Side view for simple alignment
- Application-optimised housings (e.g. fork shape for label and foil detection, tube for liquid level detection, etc.)



High accuracy in smallest size

OMRON's precise manufacturing processes with inspection system supported alignment of the fibers and lenses achieve minimal tolerance variations in all standard models and allow the detection of the smallest objects and height differences of less than 100 µm.

- High beam axis accuracy for side view models through precise fiber bending or angle mirror surface treatment
- High spot evaluation precision on coaxial models through equal fiber distribution
- Accurate distance setting through precise lens and beam alignment



Standard cylindrical fiber sensor heads

The standard cylindrical fiber optic sensing heads provide reliable object detection, easy installation and long sensor lifetime for all general applications.

- High-flex fibers and 90° cable exit for cable breakage prevention
- Models with hexagonal back for simplified one-nut mounting
- Sizes M3 to M6

Ordering information

Sensor type	Size	Sensing distance (in mm) ^{*1}		Order code	
		Standard	High-flex	Standard	High-flex
	M4	760	530	E32-TC200 2M	E32-ET11R 2M
	M3	220	130	E32-TC200E 2M	E32-ET21R 2M
	M4	–	530	–	E32-T11N 2M
	M6	250 ^{*2}	–	E32-R21	–
	M6	300	170	E32-DC200 2M	E32-ED11R 2M
	M4	80	30	E32-D211 2M	E32-D211R 2M
	M3	80	30	E32-DC200E 2M	E32-ED21R 2M
	M6	–	170	–	E32-D11N 2M
	dia 6 mm	110	45	E32-D14L 2M	E32-D14LR 2M

^{*1} Sensing distance measured with E3X-DA-S family in standard mode. In high resolution mode the sensing distance is approx. 30% higher.

^{*2} Measured with E39-R3

Specifications

Item	Standard					High Flex					
	E32_C200	E32-D14L	E32_C200E	E32-D211	E32-R21	E32-E_R	E32-D14LR	E32-D211R	E32_11N		
Permissible bending radius	R25		R10			R1					
Cut to length	Yes										
Material	Head	Brass-nickel plated	Stainless steel	Brass-nickel plated	Stainless steel	Plastic (ABS)	Brass-nickel plated	Stainless steel	Brass-nickel plated		
	Fiber	PMMA									
	Sheath	Polyethylene coating					PVC coating				
Degree of protection	IEC 60529 IP67										



Square shape fiber sensor heads

The fiber heads in square shaped housing provide fast and easy installation on flat surfaces.

- Models with sensing direction in X, Y or Z axis
- 3 or 4mm thick housings for minimal height requirement
- Standard or high-flex fibers

Ordering information

Sensor type	Size (in mm)	Sensing distance (in mm) *1		Order code	
		Standard	High-flex	Standard	High-flex
	15x18x3/ 15x10x4	760	560	E32-T15X 2M	E32-ETS10R 2M
	15x18x3	460	210	E32-T15Y 2M	E32-T15YR 2M
	15x18x3/ 15x9x4	460	480	E32-T15Z 2M	E32-ETS14R 2M
	15x10x3	300	170	E32-D15X 2M	E32-D15XR 2M
	15x10x3	100	40	E32-D15Y 2M	E32-D15YR 2M
	15x10x3/ 13x6x2.3	100	60	E32-D15Z 2M	E32-EDS24R 2M
	24.5x10x3	890	–	E32-A03-1 2M	–
	20.5x2x2	340	–	E32-A04-1 2M	–

*1 Sensing distance measured with E3X-DA-S family in standard mode. In high resolution mode the sensing distance is approx. 30% higher.

Specifications

Item	Standard		High flex	
	E32_15	E32-A	E32-E	E32_15_R
Permissible bending radius	R25	R10	R1	
Cut to length	Yes			
Material	Head	Aluminium	Brass-nickel plated	Aluminium
	Fiber	PMMA		
	Sheath	Polyethylene coating		PVC coating
Degree of protection	IEC 60529 IP67	IEC 60529 IP50	IEC 60529 IP67	



Miniature fiber sensor heads

The miniature fiber heads provide high accuracy in smallest spaces and reliable detection of minute objects.

- Sizes from dia 500 µm to 3 mm
- Side view models with precision axis alignment for highest accuracy
- Bendable sleeves for precision positioning

Ordering information

Sensor type	Size	Sensing distance (in mm) ^{*1}		Order code	
		Standard	High-flex	Standard	High-flex
	dia 3 mm	750	530	E32-T12 2M	E32-T12R 2M
	dia 2 mm	220	130	E32-T22 2M	E32-T22R 2M
	dia 1.5 mm	220	130	E32-T222 2M	E32-T222R 2M
	dia 1 mm	–	130	–	E32-T223R 2M
	dia 3 mm	460	210	E32-T14L 2M	E32-T14LR 2M
	dia 2 mm	340	–	E32-A04 2M	–
	dia 1 mm	130	50	E32-T24	E32-T24R 2M
	dia 1.2 mm	750	530	E32-TC200B	E32-TC200BR
	dia 0.9 mm	220	130	E32-TC200F	E32-TC200FR
	dia 3 mm	80	30	E32-D22 2M	E32-D22R 2M
	dia 2 mm	75	40	E32-D32 2M	E32-D32R 2M
	dia 1.5 mm	–	30	–	E32-D22B 2M
	dia 2 mm	30	15	E32-D24	E32-D24R 2M
	dia 2.5 mm	300	170	E32-DC200B 2M ^{*3}	E32-DC200BR ^{*3}
	dia 1.2 mm	80	30	E32-DC200F	E32-DC200FR
	dia 0.8 mm	–	16	–	E32-D33 2M
	dia 0.5 mm	–	3	–	E32-D331 2M

^{*1} Sensing distance measured with E3X-DA-S family in standard mode. In high resolution mode the sensing distance is approx. 30% higher.

^{*2} Models with 40 mm sleeve instead of 90 mm sleeve are available by adding '4' to the order code at the end, e.g. E32-TC200B4

^{*3} Sleeve cannot be bent

Specifications

Item	Standard						High-flex					
	E32-DC200B E32-T12 E32-TC200B	E32-T14L	E32-D32	E32-D22 E32-T222 E32-TC200F	E32-D24 E32-DC200F E32-T22 E32-T24	E32-A04	E32-D32R E32-D33 E32-D331	E32-D22B	E32-DC200BR E32-T12R E32-TC200BR	E32-D22R E32-T222R E32-TC200FR	E32-D24R E32-DC200FR E32-T14LR E32-T22R E32-T223R E32-T24R	
Permissible bending radius	R25			R10			R4		R1			
Cut to length	Yes											
Material	Head	Brass-nickel plated	Stainless steel	Brass-nickel plated	Stainless steel		Brass-nickel plated		Brass-nickel plated		Stainless steel	
	Fiber	PMMA										
	Sheath	Polyethylene coating		PVC and polyethylene	Polyethylene coating			PVC and polyethylene	PVC coating		Polyethylene coating	
Degree of protection	IEC 60529 IP67					IEC 60529 IP50	IEC 60529 IP67					



Longer distance fiber sensor heads

With built-in focal lenses the longer distance fiber heads provide enhanced operational stability in dusty environments or long distance applications

- Sensing distance up to 20 m
- Built-in focal lens
- Sizes from dia 2mm to M14

Ordering information

Sensor type	Size	Sensing distance (in mm) ^{*1}	Order code
	M14	20000	E32-T17L
	25,2x10.5x8 mm	3400	E32-T14
	M4	1330	E32-T11L 2M
	M3	680	E32-TC200A 2M
	dia 3 mm	1330	E32-T12L 2M
	dia 2 mm	440	E32-T22L 2M
	21.5x27x10 mm	1500 ^{*2}	E32-R16 2M
	22x17.5x9 mm	700	E32-D16 2M
	M6	400	E32-D11L 2M
	M4	130	E32-D21L 2M
	dia 3 mm	230	E32-D12 2M

^{*1} Sensing distance measured with E3X-DA-S family in standard mode. In high resolution mode the sensing distance is approx. 30% higher.

^{*2} Measured with E39-R1

Specifications

Item	Through-beam				Retroreflective	Diffuse reflective				
	E32-T17L/ E32-T14	E32-T11L/ E32-T12L	E32-TC200A	E32-T22L	E32-R16	E32-D16	E32-D11L	E32-D21L	E32-D12	
Permissible bending radius	R25			R10	R25	R4	R25	R10	R25	
Cut to length	Yes									
Material	Head	ABS	Brass-nickel plated	Stainless steel	ABS	Aluminium	Brass-nickel plated	Stainless steel		
	Fiber	PMMA								
	Sheath	Polyethylene coating					PVC coating	Polyethylene coating		
Degree of protection	IEC 60529 IP67					IEC 60529 IP40	IEC 60529 IP67			









Chemical resistant fiber sensor heads

The chemical resistant fibers provide long sensor lifetime in areas with frequent cleaning, usage of chemicals and higher temperatures.

- fluoroplastic cover for highest chemical resistance
- temperature resistance up to 200°C

Ordering information

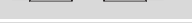
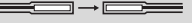
Sensor type	Size	Sensing distance (in mm) ^{*1}	Key feature	Order code
	M4	680	Fluororesin coating	E32-T11U 2M
	dia 5 mm	3,000	Fluororesin cover	E32-T12F
	dia 5 mm	1,400	Fluororesin cover	E32-T14F 2M
	M6	170	Fluororesin coating	E32-D11U 2M
	dia 6 mm	95	Fluororesin cover	E32-D12F
	dia 6 mm	40	Fluororesin cover	E32-D14F 2M
	dia 6 mm	700	Fluororesin cover Heat resistant to 200°C	E32-T81F-S 2M
	dia 5 mm	3,000	Fluororesin cover Heat resistant to 150°C	E32-T51F 2M

^{*1} Sensing distance measured with E3X-DA-S family in standard mode. In high resolution mode the sensing distance is approx. 30% higher.

Specifications

Item	Fluororesin coating		Full fluororesin cover	Full fluororesin cover and heat resistance	
	E32-T11U	E32-D11U	E32-_12F/E32-_14F	E32-T51F	E32-T81F-S
Permissible bending radius (in mm)	1	4	40		10
Cut to length	yes				no
Material	Head	Brass-nickel plated		Fluororesin	
	Fiber	PMMA			Glass
	Sheath	Fluororesin coating		Fluororesin cover	
Degree of protection	IEC60529 IP67				



Heat resistant fiber sensor heads

The wide range of heat resistant fibers provides long sensor lifetime with highest protection in demanding environments

- heat resistant up to 400°C
- sizes from dia 2 mm to M6
- models for long distances or high detection accuracy

Ordering information

Sensor type	Size	Sensing distance (in mm) ^{*1}	Key feature	Order code	
				For E3X-DA-S teachable amplifier	for E3X-NA amplifier with potentiometer adjustment
	M4	450	-40°C to 150°C	E32-ET51 2M	
	M4	280	-40°C to 200°C	E32-T81R-S 2M	
	M4	450	-60°C to 350°C	E32-T61-S 2M	
	dia 2 mm	230	-40°C to 150°C	E32-T54 2M	
	dia 3 mm	1300	-40°C to 200°C	E32-T84S-S 2M	
	M6	230	-40°C to 150°C	E32-ED51 2M	
	M6	280	-40°C to 200°C	E32-D81R-S 2M	E32-D81R 2M
	M6	150	-60°C to 350°C	E32-D61-S 2M	E32-D61 1M
	M4	60	-40°C to 400°C	E32-D73-S 2M	E32-D73
	23x20x9 mm	35	-40°C to 150°C	E32-A09H 2M	
	30x24x9 mm	25	-40°C to 300°C	E32-A09H2 2M	

*1 Sensing distance measured with E3X-DA-S family in standard mode. In high resolution mode the sensing distance is approx. 30% higher.

Specifications

Item	-40°C to 150°C			-40°C to 200°C		-40°C to 300°C	-60°C to 350°C	-40°C to 400°C	
	E32-E_51	E32-T54	E32-A09H	E32- 81_	E32-T84_	E32-A09H2	E32- 61_	E32-D73_	
Permissible bending radius (in mm)	R35			R10	R25				
Cut to length	Yes			No					
Material	Head	Brass-nickel plated	Stainless steel	Aluminium	Stainless steel				
	Fiber	Fluoro resin	PMMA	Glass					
	Sheath	Fluoro resin			Stainless steel spiral coating	Stainless steel tube	Stainless steel spiral coating	Stainless steel tube	
Degree of protection	IEC 60529 IP67								



Vacuum resistant fiber sensor heads

For applications in cleanest and hot environments the vacuum resistant fibers and connecting flanges provide long operational lifetime and vacuum integrity.

- Leakage rate of 1×10^{-10} Pa·m³/s max
- Heat resistance up to 200°C
- Detergent resistant fluororesin or stainless steel fiber sheath

Ordering information

Sensor

Sensor type	Size	Sensing distance (in mm) ^{*1}	Temperature range	Order code
	M4	200	-40°C to 120°C	E32-T51V 1M
	dia 3	130	-40°C to 120°C	E32-T54V 1M
	dia 3	480	-60°C to 200°C	E32-T84SV 1M

^{*1} Sensing distance measured with E3X-DA-S family in standard mode. In high resolution mode the sensing distance is approx. 30% higher.

Flange

Type	Size	Order code
4 channel flange	80x80x49 mm	E32-VF4
1 channel flange	96 x dia30 mm max.	E32-VF1
Flange-to-amplifier connection fiber	2 m length	E32-T10V 2M

Specifications

Item	Fiber sensor heads			Flange-to-amplifier fiber
	E32-T51V	E32-T54V	E32-T84SV	E32-T10V
Permissible bending radius	R30		R25	
Cut to length	No			Yes
Material	Head	Aluminium	Stainless steel	–
	Fiber	Glass		PMMA
	Sheath	Fluororesin coating	Stainless steel spiral coating	Polyethylene coating
Degree of protection	–			

Item	Flange	
	E32-VF1	E32-VF4
Leakage rate	1×10^{-10} Pa·m ³ /s max	
Ambient temperature	-25°C to 55°C	
Material	Flange	Aluminium and stainless steel
	Seal	Fluorocarbon rubber (viton)







Robot application fiber sensor heads

For applications on frequently or fast moving parts, the robot fibers reduce the risk of fiber breakage with a guaranteed operational life of more than 1 million bending cycles

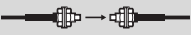
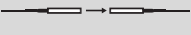
- Free moving multicore fibers for > 1 mio bending cycles
- Square shapes for easy surface installation
- Cylindrical sizes from dia 1.5 mm to M6

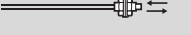
Ordering information

Sensor type	Size	Sensing distance (in mm) ^{*1}	Order code
	M4	680	E32-T11 2M
	M3	200	E32-T21 2M
	dia 3 mm	680	E32-T12B
	dia 2 mm	200	E32-T221B
	dia 1.5 mm	200	E32-T22B
	15x18x3 mm	680	E32-T15XB 2M
	M6	170	E32-D11 2M
	M4	70	E32-D21B 2M
	M3	30	E32-D21 2M
	dia 1.5 mm	30	E32-D22B 2M
	15x10x3 mm	170	E32-D15XB 2M

^{*1} Sensing distance measured with E3X-DA-S family in standard mode. In high resolution mode the sensing distance is approx. 30% higher.

Specifications

Item	Square		Cylindrical			
	E32-D15XB E32-T15XB		E32-T21	E32-D11 E32-T11	E32-D21 E32-T12B E32-T22B	E32-D21B E32-D22B E32-T221B
Permissible bending radius	R4					
Cut to length	Yes					
Material	Head	Aluminium	Brass-nickel plated			Stainless steel
	Fiber	PMMA				
	Sheath	PVC coating	Polyethylene coating	PVC coating		
Degree of protection	IEC 60529 IP67					



Precision detection fiber sensor heads

Highest precision in design and manufacturing of the fibers and focal lenses ensure highest beam and spot accuracy allowing the detection of smallest objects and height differences of less than 100 µm.

- Coaxial fibers with focal lenses for spot diamters of 100 µm
- Through-beam models with highly focused beam and precise optical axis alignment
- Limited reflective models for height difference detection of less than 100 µm

Ordering information

Sensor type	Preferred usage	Size	Key feature	Sensing distance (in mm) ^{*1}	Order code
	Precise thin object detection / accurate positioning	dia 3 mm	- High precision optical axis adjustment - Very focused beam	1900	E32-T22S
		dia 3 mm		890	E32-A03 2M
		dia 2 mm		340	E32-A04 2M
	Very small object detection	M6	-	300	E32-CC200 2M ^{*2}
		M3	Spot dia 0.5 mm	20	E32-EC31 2M
		M3	Spot dia 0.2 mm	17	E32-EC41 1M + E39-F3B
		M3	Spot dia 0.1 mm	7	E32-EC41 1M + E39-F3A-5
		dia 3 mm	-	150	E32-D32L
		dia 2 mm	-	75	E32-D32 2M ^{*2}
		M6	- 90° cable exit - Hexagonal back	170	E32-C11N 2M
		M3	-	25	E32-C31N 2M
		M3	Small spot	8-25 m adjustable	E32-EC31 2M + E39-EF51
		dia 2 mm	Spot dia 0.5 to 1 mm	6-15 mm adjustable	E32-D32 2M + E39-F3A
dia 2 mm	Spot dia 0.1 to 0.6 mm	6-15 mm adjustable	E32-C42 1M		
	Precision height difference detection / flat surface detection	23x20x9 mm	-	35	E32-A09 2M
		16x18x4 mm	-	7.2	E32-L25L ^{*2}
		20x20x5 mm	-	3.3	E32-L25
		18x20x4 mm	Precise spot e.g. for detection of a flat / reflective surface	4	E32-L24L ^{*2}
		34x25x8	Vaery precise spot (detection accuracy 100 µm)	2.4	E32-EL24-1 2M
	Object detection in front of background	22.5x17.5x3.8 mm	Wide beam e.g. for object detection on a flat surface	15	E32-L16 2M

^{*1} Sensing distance measured with E3X-DA-S family in standard mode. In high resolution mode the sensing distance is approx. 30% higher.

^{*2} A high flex cable version is available. Add 'R' to the order code, e.g. E32-CC200R

Specifications

Item	Through-beam			Diffuse reflective (coaxial)				Limited reflective				
	E32-T22S	E32-A03	E32-A04	E32-C11N E32-C31N	E32-CC200	E32-C42 E32-D32/-D32L E32-EC31/-EC41	E32-EL24-1	E32-L24L E32-L25L	E32-L25	E32-L16	E32-A09	
Permissible bending radius	R10	R1	R10	R4	R25		R10		R25			
Cut to length	Yes											
Material	Head		Brass-nickel plated	Stainless steel	Brass-nickel plated	Stainless steel	Brass-nickel plated and aluminium	Polycarbonate	ABS		Aluminium	
	Fiber		PMMA									
	Sheath		PVC coating	Polyethylene coating		PVC coating	PVC, polyethylene and polyolefin coating	Polyethylene coating				
Degree of protection	IEC 60529 IP67	IP50		IEC 60529 IP67				IEC 60529 IP50		IEC 60529 IP40		

Area monitoring fiber sensor heads

The area monitoring fibers allow the detection of objects passing anywhere through the detection range and can be used for height comparisons of different objects.

- Area monitoring up to 70 mm height
- Multi-beam sensor with 4 separate heads for flexible detection points
- Standard or high flex fibers



Ordering information

Sensor type	Area height (in mm)	Sensing distance (in mm) ^{*1}		Order code	
		Standard	High-flex	Standard	High-flex
	10	2800	–	E32-T16	–
	11	1100	840	E32-T16P	E32-T16PR 2M
	30	1800	1300	E32-T16W 2M	E32-T16WR 2M
	50	–	1800	–	E32-ET16WR-2 2M
	70	–	2000	–	E32-ET16WR-1 2M
	11	1000	750	E32-T16J 2M	E32-T16JR 2M
	4* separate M3 heads	610	–	E32-M21	–
	11	–	150	–	E32-D36P1 2M

^{*1} Sensing distance measured with E3X-DA-S family in standard mode. In high resolution mode the sensing distance is approx. 30% higher.

^{*2} Sensing area aligned to top of housing.

Specifications

Item	Standard			High-flex			
	E32-T16	E32-M21	E32-T16J E32-T16P E32-T16W	E32-D36P1	E32-ET16WR-1 E32-ET16WR-2	E32-T16JR E32-T16PR E32-T16WR	
Permissible bending radius	R25		R10	R4	R1		
Cut to length	Yes						
Material	Head	ABS	Stainless steel	ABS	Brass-nickel plated	Aluminium	ABS
	Fiber	PMMA					
	Sheath	Polyethylene coating		PVC coating	Polyethylene coating		PVC coating
Degree of protection	IEC 60529 IP67		IEC 60529 IP50		IEC 60529 IP54		IEC 60529 IP50



Special application fiber sensor heads

For a wide range of special applications, the task optimised fiber heads provide best fitting sensing performance and adaption to environmental requirements.

- Detection of special objects (liquids, transparent foils, etc.)
- Fiber heads ideal for colour mark detection
- Fiber heads optimised for special tasks (wafer mapping, hot reflective surface detection, etc.)

Ordering information

Sensor Type	Size	Sensing distance (in mm) *1	Comment	Order code
Fork shape	36x24x8 mm	10	-	E32-G14
Wafer mapping	dia 3	1900	-	E32-T22S
	dia 3	1300	-	E32-T24S
	dia 3	890	-	E32-A03 2M
	dia 2	340	-	E32-A04 2M
Liquid level sensor	dia 6	liquid contact	Liquid level contact	E32-D82F1 4M
	15x23.5x5 mm	tube contact	Liquid level detection through transparent tube or container	E32-D36T 2M
Label detection	20x20x5 mm	7.2	-	E32-L25L
	18x20x4 mm	4	-	E32-L24L
	34x25x8 mm	2.4	Very precise spot (detection accuracy 100 µm)	E32-EL24-1 2M
Colour detection **2	M6	300	Recommended for standard colour and colour mark detection	E32-CC200 2M
	23x20x9 mm	35	Recommended for higher precision colour and colour mark detection	E32-A09 2M
	M3	20	Recommended for very precise colour mark detection	E32-EC31 2M
Transparent foil detection	M4	depends on application	With amplifier E3X-DA_-S and power tuning functionality	E32-ET11R + E39-F1
	36x24x8 mm	10	- Fork shape for simplified mounting - Only with amplifier E3X-DAC_-S	E32-G14
Detection of hot reflective surfaces	36x18x5.5 mm	18	- Heat resistant up to 300°C - Limited reflective for accurate detection of shiny surfaces - Wide beam for tilt resistance - tolerance of object surface	E32-L66 2M





*1 Sensing distance measured with E3X-DA-S family in standard mode. In high resolution mode the sensing distance is approx. 30% higher.

**2 With amplifier E3X-DAC-S

Specifications

Item	E32-D82F1	E32-G14	E32-A09	E32-CC200	E32-EC31	E32-L66	E32-EL24-1	E32-T22S E32-T24S	E32-L24L E32-L25L	E32-A04	E32-D36T	E32-A03	E32-ET11R
Permissible bending radius	R40	R25					R10				R4	R1	
Cut to length	Yes					No	Yes						
Material	Head	PFA	ABS	Aluminium	Brass-nickel plated	Stainless steel	Brass-nickel plated and aluminium	Brass-nickel plated	Stainless steel	ABS		Brass-nickel plated	
	Fiber	PMMA					Glass	PMMA					
Sheath	Polyethylene coating			PVC, polyethylene and polyolefin coating		Stainless steel spiral coating	Polyethylene coating	PVC coating	Polyethylene coating		PVC coating	Polyethylene coating	PVC coating
Degree of protection	IEC 60529 IP67		IEC 60529 IP40	IEC 60529 IP67		IEC 60529 IP40	IEC 60529 IP67		IEC 60529 IP50		IEC 60529 IP67	IEC 60529 IP50	IEC 60529 IP67

Accessories

Shape	Type	Comment	Order code
	Focal lens	- Extends sensing distance by more than 500% - For M4 Through beam fibers E32-TC200, E32-ET11R, E32-T11 (fits M2.6 thread) - 2 pcs per set	E39-F1
	Focal lens (side view)	- For M4 through beam fibers E32-TC200, E32-ET11R, E32-T11, E32-T61-S, E32-T81R-S (fits M2.6 thread) - Temperature range -40°C to +200°C - 2 pcs per set	E39-F2
	Focal lens (variable)	- For precision detection with E32-D32	E39-F3A
	Focal lens	- For precision detection with E32-EC41	E39-F3A-5
	Focal lens	- For precision detection with E32-EC41	E39-F3B
	Focal lens (side view, variable)	- For precision detection with E32-EC31	E39-EF51
	Focal lens (heat resistant)	- Extends sensing distance by more than 500% - For M4 through beam fibers E32-ET51, E32-T61, E32-T61-S, E32-T81R, E32-T81R-S (fits M4 thread) - Temperature range -60°C to +350°C - 2 pcs per set	E39-EF1-37
	Focal lens (vacuum resistant, heat resistant)	- Fits E32-T51V and E32-T54V (fits M2.6 thread) - 2 units per set - Heat resistant up to 120°C	E39-F1V
	Fiber cutter	- Included in applicable fiber	E39-F4
	Thin fiber attachment	- Amplifier adapter for thin fibers - Included in applicable fiber (2 sets)	E39-F9
	Sleeve bender	- For E32-TC200B(4) - For E32-TC200F(4) - For E32-DC200F(4)	E39-F11
	Single fiber extension connector	- Fiber extension connector for 2.2 mm dia standard fibers - One unit	E39-F10
	Dual fiber extension connector	- For fibers with dia 2.2	E39-F13
		- For fiber with dia 1.0	E39-F14
		- For fibers with dia between 1.0 and 2.2	E39-F15
	Protective spiral tube *1	- For M3 diffuse type sensors - Length 1 m	E39-F32A
		- For M3 through beam type sensors - Length 1 m	E39-F32B
		- For M4 through beam type sensors - Length 1 m	E39-F32C
		- For M6 diffuse type sensors - Length 1 m	E39-F32D
	Fiber on roll *2	- Dia 2.2 mm - Standard monocoire, 10 mm bending radius - -40°C to 80°C	E32-E01 100M
		- Dia 1.1 mm - Standard monocoire, 4 mm bending radius - -40°C to 80°C	E32-E02 100M
		- Dia 2.2 mm - High flex multicore, 1 mm bending radius - -40°C to 80°C	E32-E01R 100M
		- Dia 1.1 mm - High flex multicore, 1 mm bending radius - -40°C to 80°C	E32-E02R 100M
		- Dia 2.2 mm - High temperature monocoire, 20 mm bending radius - -60°C to 150°C	E32-E05 100M
		- Dia 2.2 mm - High temperature monocoire, 20 mm bending radius - -60°C to 150°C	E32-E05 100M
	Reflectors	- Size 60 x 40.3 x 7.5	E39-R1S
		- Size 42 x 22.5 x 11	E39-R3

*1 Protective spiral tubes with 0.5 m length are available. Add '5' to order code...e.g. E39-F32A5

*2 Fiber length 100 m on a roll - cuttable

Digital fiber amplifier with one button teaching



E3X-DA-SE-S allows easy one button setting and provides the best value performance ratio for standard applications.

- Auto-teaching during machine operation
- Digital double display for incident level and threshold
- Object or 2-point teaching within a few seconds

Ordering information

Item	Order code	
	NPN output	PNP output
Pre-wired	E3X-DA11SE-S 2M	E3X-DA41SE-S 2M
Connector version ^{*1}	E3X-DA6SE-S	E3X-DA8SE-S

^{*1} Order connector separately.

Specifications

Item	E3X-DA_SE-S	
Light source (wave length)	Red LED (650 nm)	
Power supply voltage	12 to 24 VDC ±10%, ripple (p-p): 10% max.	
Protective circuits	Power supply reverse polarity protection, output short-circuit protection, mutual interference prevention	
Response time	Operation or reset: 1 ms	
Sensitivity setting	Teaching and digital up/down keys	
Functions	Auto power control	High-speed control method for emission current
	Mutual interference prevention	Optical communications sync, possible for up to 10 Units
Digital displays	Incident level + threshold	

1-button auto-teaching

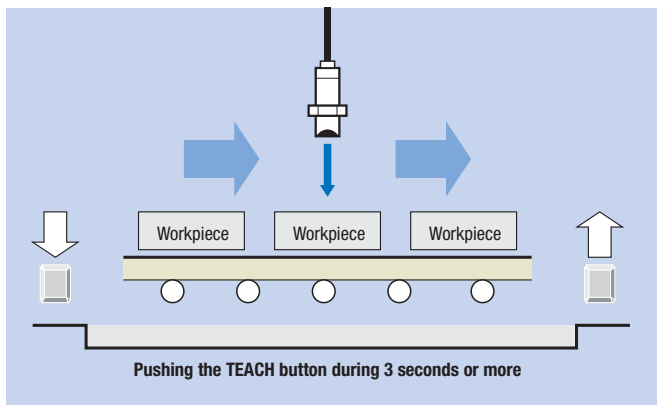

2-point teaching

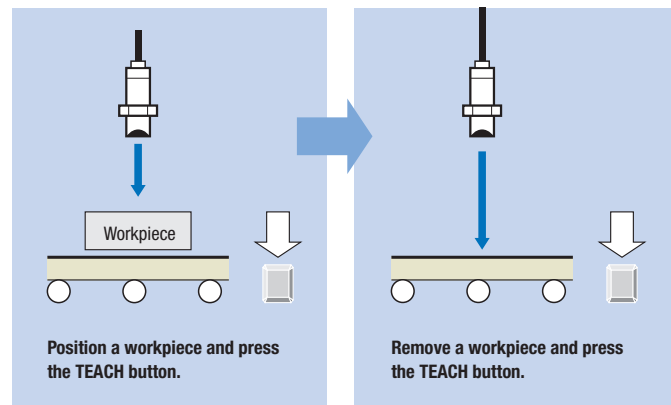

Fiber amplifier connectors

Shape	Type	Comment	Order code
	Fiber amplifier connector	2 m PVC cable	E3X-CN21
		30 cm PVC cable with M12 plug connector (4 pin)	E3X-CN21-M1J 0.3M
		30 cm PVC cable with M8 plug connector (4 pin)	E3X-CN21-M3J-2 0.3M

Digital fiber amplifier for basic applications

The E3X-NA/E3X-SD is the ideal amplifier for basic fiber applications providing quick & easy adjustment.

- Easy adjustment with potentiometer (E3X-NA) or up/down keys (E3X-SD)
- Mutual interference prevention
- Enhanced water resistance types



Ordering information

Pre-wired

Item	Order code (for pre-wired types with 2 m cable length)			
	Manual adjuster		Up/down keys	
	NPN output	PNP output	NPN output	PNP output
Standard	E3X-NA11 2M	E3X-NA41 2M	E3X-SD11 2M	E3X-SD41 2M
Enhanced water resistance	E3X-NA11V 2M	E3X-NA41V 2M	-	-

Connector version

Item	Order code			
	NPN output		PNP output	
	Up/down keys		PNP output	
Standard ^{*1}	E3X-NA6	E3X-NA8	E3X-SD6	E3X-SD8
Enhanced water resistance ^{*2} (M8 connector)	E3X-NA14V	E3X-NA44V	-	-

^{*1} Order connector separately.

^{*2} for M8 connector cables refer to accessory datasheet E26E

Specifications

Item	Manual adjuster		Up/down keys
	Standard	Enhanced water resistance	Standard
Output	NPN output E3X-NA11, E3X-NA6	E3X-NA11V, E3X-NA14V	E3X-SD6/E3X-SD11
	PNP output E3X-NA41, E3X-NA8	E3X-NA41V, E3X-NA44V	E3X-SD8/E3X-SD41
Light source (wave length)	Red LED (680 nm)		Red LED (620 nm)
Power supply voltage	12 to 24 VDC ±10%, ripple (p-p): 10% max.		
Protective circuit	Reverse polarity protection, output short-circuit protection, mutual interference prevention		
Response time	Operation or reset: 200 μs max.		
Sensitivity setting	8-turn endless adjuster (potentiometer)		Digital up/down keys
Functions	OFF-delay timer: 40 ms (fixed)		
Degree of protection	IEC 60529 IP50 (with protective cover attached)	IEC 60529 IP66 (with protective cover attached)	IEC 60529 IP50 (with protective cover attached)

Fiber amplifier connectors

Shape	Type	Comment	Order code
	Fiber amplifier connector	2 m PVC cable	E3X-CN21
		30 cm PVC cable with M12 plug connector (4 pin)	E3X-CN21-M1J 0.3M
		30 cm PVC cable with M8 plug connector (4 pin)	E3X-CN21-M3J-2 0.3M

High functionality digital fiber amplifier

High functionality digital fiber amplifier with two large displays for excellent visibility even from a distance.

- Advanced timing, LED power and signal processing functions
- High resolution for long sensing distances and accurate settings
- Auto Power Control for long-term stability



Ordering information

Pre-wired

Item		Order code (for pre-wired types with 2 m cable length)	
		NPN output	PNP output
Standard models	Red light	E3X-DA11-S 2M	E3X-DA41-S 2M
	Infrared light	E3X-DAH11-S 2M	E3X-DAH41-S 2M
Twin-output models		E3X-DA11TW-S 2M	E3X-DA41TW-S 2M
External-input models		E3X-DA11RM-S 2M	E3X-DA41RM-S 2M

Connector version

Item		Order code	
		NPN output	PNP output
Standard models ^{*1}	Red light	E3X-DA6-S	E3X-DA8-S
	Infrared light	E3X-DAH6-S	E3X-DAH8-S
Twin-output models ^{*1}		E3X-DA6TW-S	E3X-DA8TW-S
External-input models ^{*1}		E3X-DA6RM-S	E3X-DA8RM-S

^{*1} Order connector separately

Specifications

Amplifier units with cables

Item		Standard models		Twin-output models	External-input models	
		NPN output	E3X-DA11-S, E3X-DA6-S	E3X-DAH11-S, E3X-DAH6-S	E3X-DA11TW-S, E3X-DA6TW-S	E3X-DA11RM-S, E3X-DA6RM-S
		PNP output	E3X-DA41-S, E3X-DA8-S	E3X-DAH41-S, E3X-DAH8-S	E3X-DA41TW-S, E3X-DA8TW-S	E3X-DA41RM-S, E3X-DA8RM-S
Light source (wave length)		Red LED (650 nm)		Infrared LED	Red LED (650 nm)	
Power supply voltage		12 to 24 VDC ±10%, ripple (p-p) 10% max.				
Protective circuits		Power supply reverse polarity protection, output short circuit protection, mutual interference prevention				
Response time	Super-high-speed mode	NPN	48 μs for operation and 50 μs for reset		80 μs for operation and reset	48 μs for operation and 50 μs for reset
		PNP	53 μs for operation and 55 μs for reset			
	Standard mode		1 ms for operation and reset respectively			
	High-resolution mode		4 ms for operation and reset respectively			
Sensitivity setting		Teaching and digital up/down keys				
Functions	Power tuning	Light emission power and reception gain, digital control method				
	Timer function	Select from OFF-delay, ON-delay, or one-shot timer. 1 ms to 5 s (1 to 20 ms set in 1-ms increments, 20 to 200 ms set in 10-ms increments, 200 ms to 1 s set in 100-ms increments, and 1 to 5 s set in 1 s-increments)				
	I/O settings	-		Output setting (Select from channel 2 output, area output, or self-diagnosis.)	External input setting (Select from teaching, power tuning, zero reset, light OFF, or counter reset.)	
Digital displays		Incident level + threshold or user specific				

Fiber amplifier connectors

Shape	Type	Comment	Order code
	Fiber amplifier connector	2 m PVC cable	E3X-CN21
		30 cm PVC cable with M12 plug connector (4 pin)	E3X-CN21-M1J 0.3M
		30 cm PVC cable with M8 plug connector (4 pin)	E3X-CN21-M3J-2 0.3M

Digital fiber amplifier with active threshold control for dust and dirt compensation



The active threshold E3X-DA-AT-S digital fiber amplifier compensates for light power reduction caused by dirt and ensures stable operation.

- Active threshold control for high stability
- Alarm output for maintenance warning
- Area detection function for quality inspection or sensing range control

Ordering information

Item	Functions	Order code	
		NPN output	PNP output
Pre-wired version	ATC (active threshold control)	E3X-DA11AT-S	E3X-DA41AT-S
Connector version ^{*1}	ATC error alarm output	E3X-DA6AT-S	E3X-DA8AT-S

^{*1} Order connector separately.

Specifications

Item	NPN output	E3X-DA11AT-S	E3X-DA6AT-S
	PNP output	E3X-DA41AT-S	E3X-DA8AT-S
Light source (wave length)	Red LED (650 nm)		
Power supply voltage	12 to 24 VDC \pm 10%, ripple (p-p): 10% max.		
Protective circuits	Power supply reverse polarity protection, output short circuit protection, mutual interference prevention		
Response time	Super-high-speed mode	Operation or reset: 80 μ s	
	High-speed mode	Operation or reset: 250 μ s	
	Standard mode	Operation or reset: 1 ms	
	High-resolution mode	Operation or reset: 4 ms	
Sensitivity setting	Teaching and digital up/down keys		
Functions	ATC	Active threshold control (used for output 1)	
	I/O settings	Used for output 1: ATC error alarm output	
	Startup operation	The operation when power is turned ON can be selected: no operation, power tuning or power tuning + ATC	
Digital display	Incident level + threshold or user specific		

Timing diagram of signal changes with and without ATC

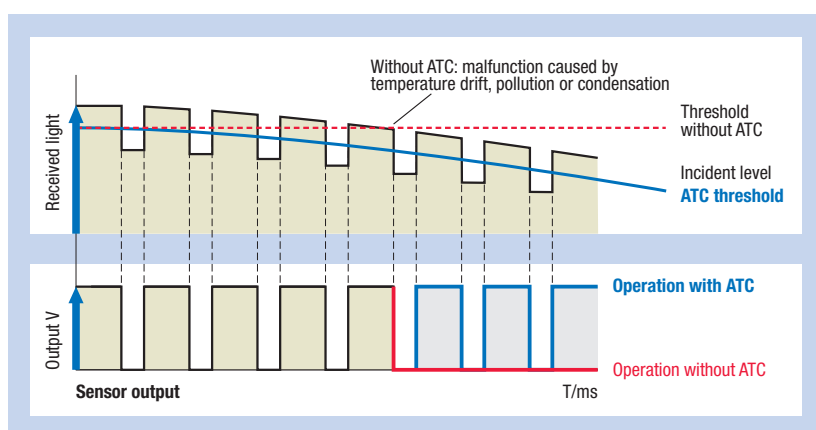

Fiber amplifier connectors

Shape	Type	Comment	Order code
	Fiber amplifier connector	2 m PVC cable	E3X-CN21
		30 cm PVC cable with M12 plug connector (4 pin)	E3X-CN21-M1J 0.3M
		30 cm PVC cable with M8 plug connector (4 pin)	E3X-CN21-M3J-2 0.3M



Fast response digital amplifier with potentiometer

The E3X-NA_F provides a very fast response time and is the ideal amplifier for high speed detection applications.

- Short turn on time of only 20 μ s
- Easy adjustment with potentiometer

Ordering information

Pre-wired

Item	Order code	
	NPN output	PNP output
High-speed detection models	E3X-NA11F	E3X-NA41F

Specifications

Item	NPN output	E3X-NA11F
	PNP output	E3X-NA41F
Light source (wave length)	Red LED (680 nm)	
Power supply voltage	12 to 24 VDC \pm 10%, ripple (p-p): 10% max.	
Protective circuit	Reverse polarity protection, output short-circuit protection, mutual interference prevention	
Response time	Operation: 20 μ s max. Reset: 30 μ s max.	
Sensitivity adjustment	8-turn endless adjuster (potentiometer)	
Functions	OFF-delay timer: 40 ms (fixed)	
Degree of protection	IEC 60529 IP50 (with protective cover attached)	

2-in-1 Digital fiber amplifier



E3X-MDA incorporates 2 digital fiber amplifiers in one slimline housing. For applications requiring the detection of two objects simultaneously the E3X-MDA provides an easy to use operation saving space and set-up time.

- Two digital amplifiers in one slimline housing
- Twin output models – on/off or area (between two threshold values)
- Signal comparison functions (AND, OR, etc.)

Ordering information



Item	Functions	Order code	
		NPN output	PNP output
Pre-wired	AND/OR output	E3X-MDA11	E3X-MDA41
Connector version ^{*1}	AND/OR output	E3X-MDA6	E3X-MDA8

^{*1} Order connector separately.

Specifications

Item	E3X-MDA
Light source (wave length)	Red LED (650 nm)
Power supply voltage	12 to 24 VDC ±10%, ripple (p-p) 10% max.
Protective circuits	Power supply reverse polarity protection, output short-circuit protection, mutual interference prevention
Response time	Super-high-speed mode
	Standard mode
	High-resolution mode
Sensitivity setting	Teaching and digital up/down keys
Functions	Power tuning
	Timer function
	I/O settings
Digital displays	Select from the following: Incident level for channel 1 + incident level for channel 2, Incident level + threshold, incident level percentage + threshold, incident light peak level + no incident light bottom level, minimum incident light peak level + maximum no incident light bottom level, long bar display, incident level + peak hold, incident level + channel

Fiber amplifier connectors

Shape	Type	Comment	Order code
	Fiber amplifier connector	2 m PVC cable	E3X-CN21
		30 cm PVC cable with M12 plug connector (4 pin)	E3X-CN21-M1J 0.3M
		30 cm PVC cable with M8 plug connector (4 pin)	E3X-CN21-M3J-2 0.3M



E3X-DAC-S colour (RGB) digital fiber amplifier

The E3X-DAS-C detects the colour of a workpiece and enables it to be compared with a stored RGB ratio to identify coloured marks or workpieces. Moreover, it does this independent of the light intensity and minor sensing distance variations.

- White LED for colour independence
- Fast response time of min. 60 µs
- Timer function for variable ON or OFF delay up to 5 s
- Remote teaching or easy one-button teaching

Ordering information

Pre-wired

Item	Functions	Order code (for pre-wired types with 2 m cable length)	
		NPN output	PNP output
Standard models	Timer, response speed change	E3X-DAC11-S	E3X-DAC41-S
Advanced models	Standard models + simultaneous determination (2 colours) AND/OR output, remote setting	E3X-DAC21-S	E3X-DAC51-S

Connector versions

Item	Functions	Order code	
		NPN output	PNP output
Standard models *1	Timer, response speed change	E3X-DAC6-S	E3X-DAC8-S

*1 Order connector separately

Specifications

Item	Standard models		Advanced models
	E3X-DAC1, E3X-DAC4 E3X-DAC6, E3X-DAC8		E3X-DAC2, E3X-DAC5
Light source (wave length)	White LED (420 to 700 nm)		
Sensing method	C Mode: RGB ratio determination (or I Mode: Light intensity determination for red, green, or blue)		
Number of registered colours	1	2 (simultaneous determination)	
Power supply voltage	12 to 24 VDC ±10%, ripple (p-p) 10% max.		
Protective circuits	Power supply reverse polarity protection, output short circuit protection, output reverse polarity protection, mutual interference prevention		
Response time	Super-high-speed mode Operation or reset: 60 µs High-speed mode Operation or reset: 300 µs Standard mode Operation or reset: 1 ms High-resolution mode Operation or reset: 4 ms	Operation or reset: 120 µs Operation or reset: 600 µs Operation or reset: 2 ms Operation or reset: 8 ms	
Sensitivity setting (colour registration, allowable range)	Teaching (one-point teaching or teaching with/without workpiece) or manual adjustment		
Functions	Operating mode	ON for match (ON for same colour as registered colour) or ON for mismatch (ON for different colour from registered colour)	
	Timer function	Timer type: OFF delay, ON delay, or one-short Timer time: 1 ms to 5 s (variable)	
	Control outputs	–	
	Remote control	–	
Degree of protection	IEC60529 IP50 (with protective cover attached)		

Fiber amplifier connectors

Shape	Type	Comment	Order code
	Fiber amplifier connector	2 m PVC cable	E3X-CN21
		30 cm PVC cable with M12 plug connector (4 pin)	E3X-CN21-M1J 0.3M
		30 cm PVC cable with M8 plug connector (4 pin)	E3X-CN21-M3J-2 0.3M

Product dimensions

E32-D11N

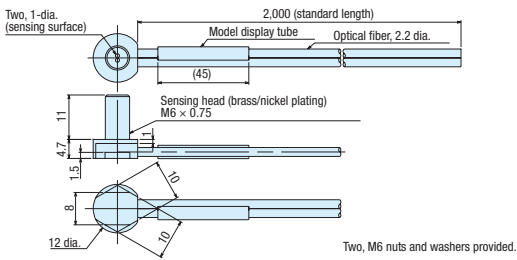

E32-D12

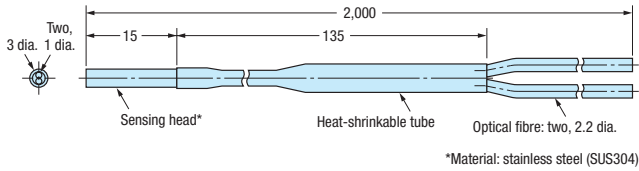

E32-D12F

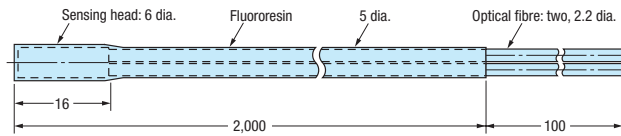

E32-D14F

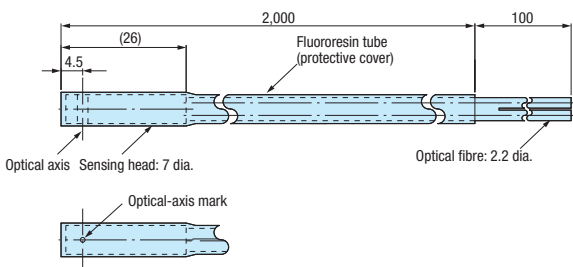

E32-D14L, E32-D14LR

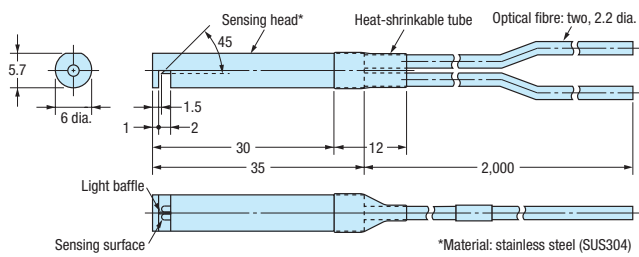

E32-D15X, E32-D15XB, E32-D15XR

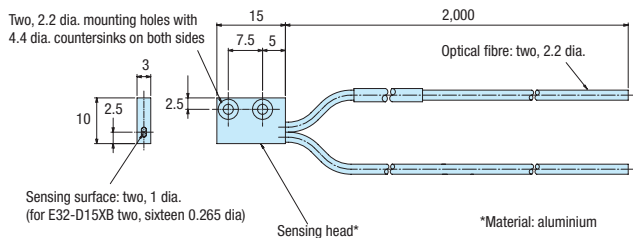

E32-D15Y, E32-D15YR

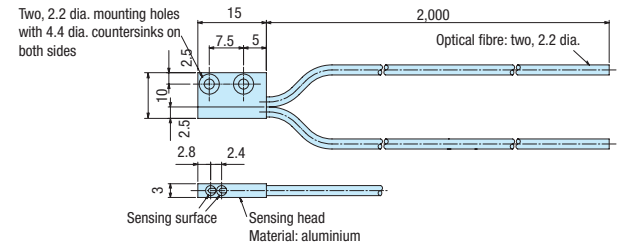

E32-D15Z

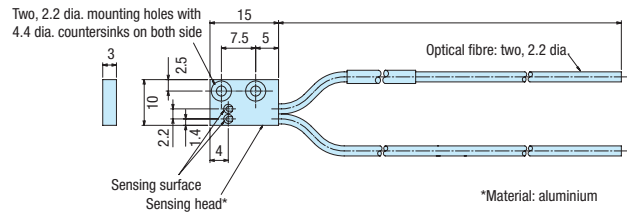

E32-D16

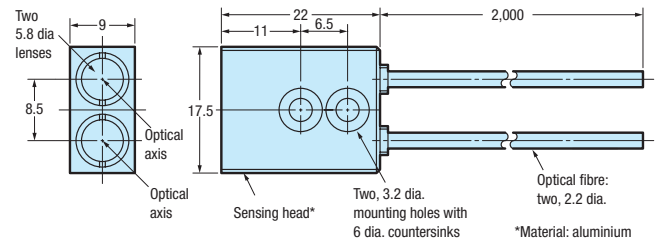

E32-D21

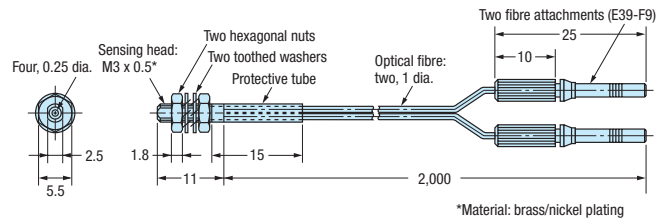

E32-D21B

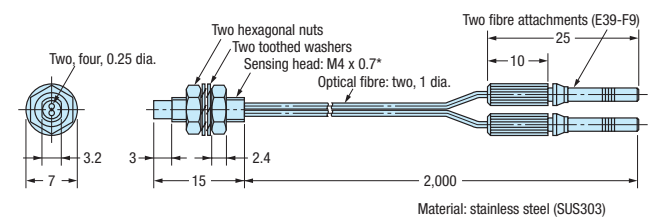

E32-D21L

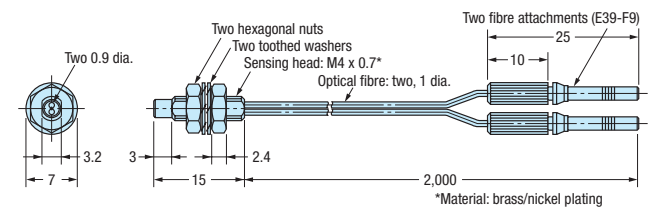

Product dimensions

E32-D22, E32-D22R

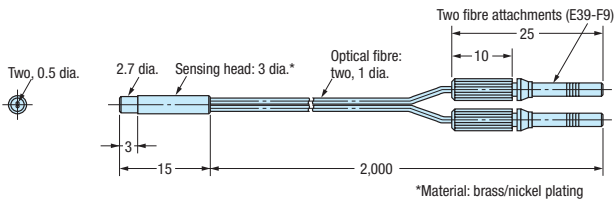

E32-D22B

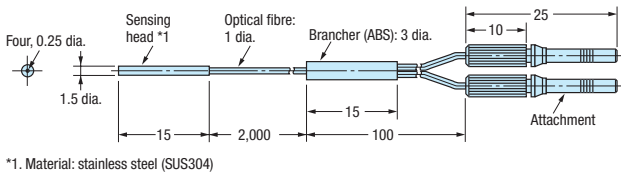

E32-D24, E32-D24R

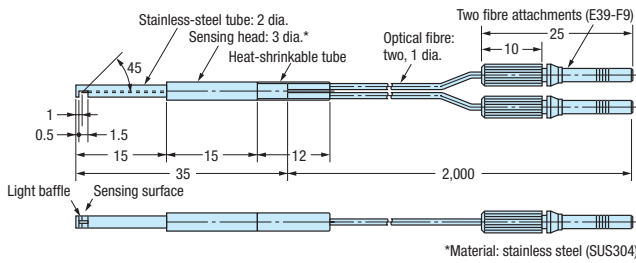

E32-D32 / E32-D32R

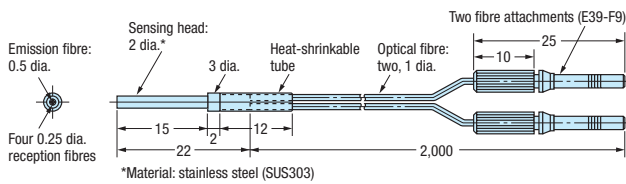

E32-D32L

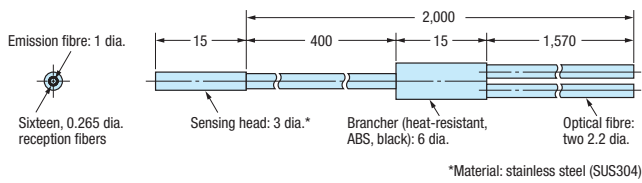

E32-D33

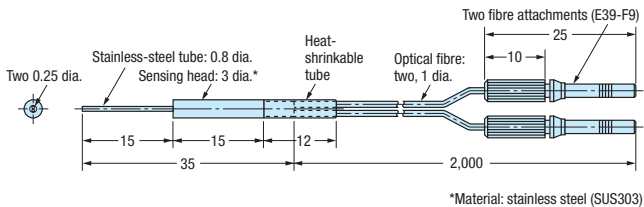

E32-D36P1

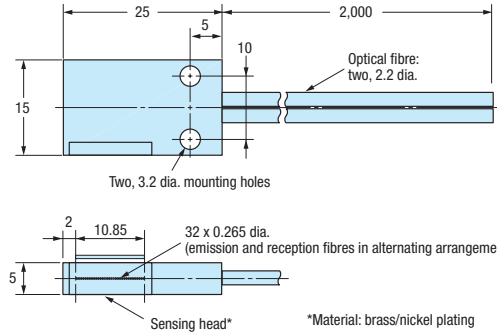

E32-D36T

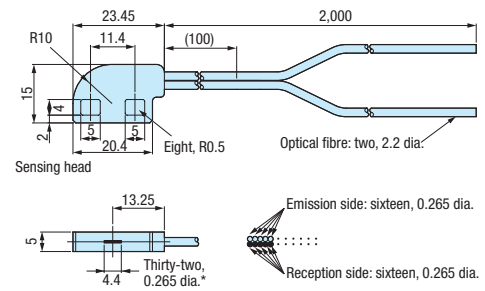

E32-D61-S, E32-D61

Using the E32-D61-S

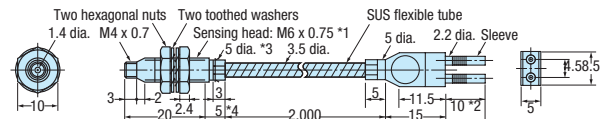

Using the E32-D61

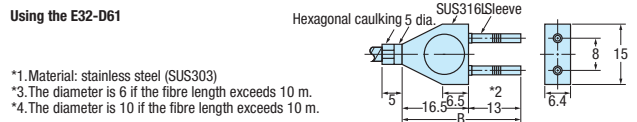

*1. Material: stainless steel (SUS303)

*3. The diameter is 6 if the fibre length exceeds 10 m.
*4. The diameter is 10 if the fibre length exceeds 10 m.

E32-D73-S, E32-D73

Using the E32-D73-S

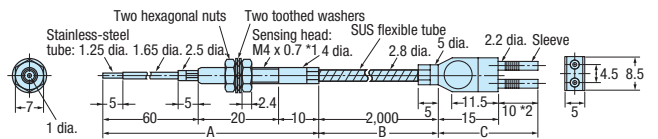

Using the E32-D73

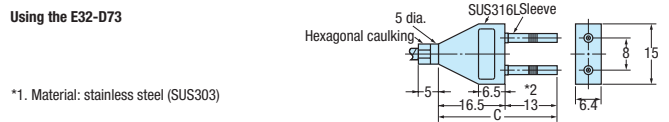

*1. Material: stainless steel (SUS303)

E32-D81R-S, E32-D81R

Using the E32-D81R-S

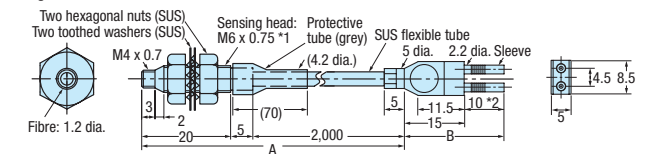

Using the E32-D81R



*1. Material: stainless steel (SUS303)

Product dimensions

E32-D82F1

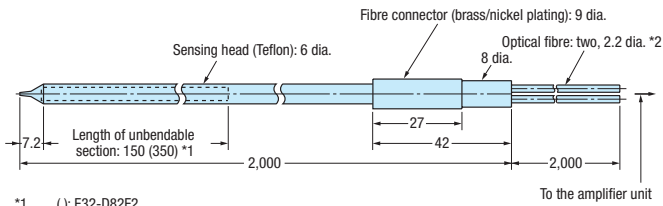

- *1. (): E32-D82F2
- *2. The 2-m section of optical fiber on the amplifier unit side is plastic and therefore allows free cutting.

E32-D211, E32-D211R

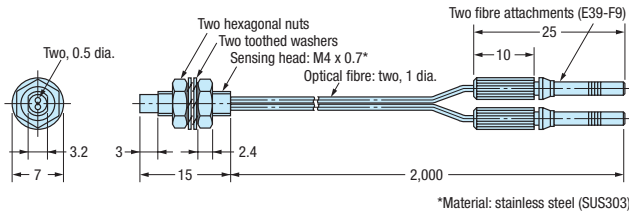

E32-D331

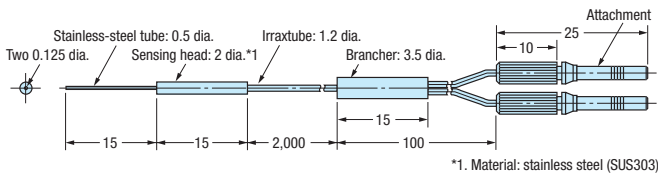

E32-DC200

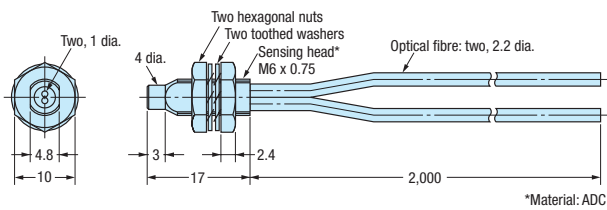

E32-DC200B, E32-DC200BR

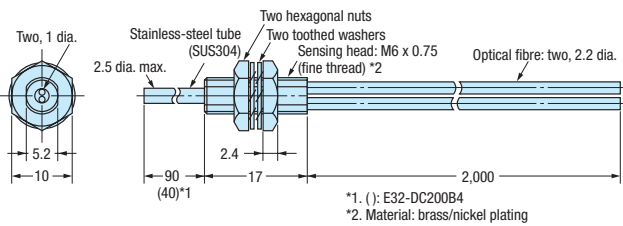

E32-DC200E

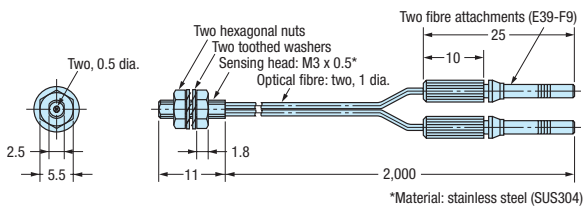

E32-DC200F, E32-DC200FR

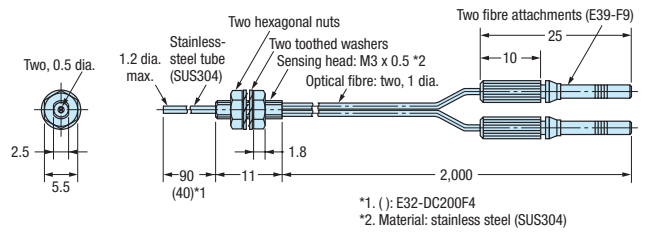

E32-EC31

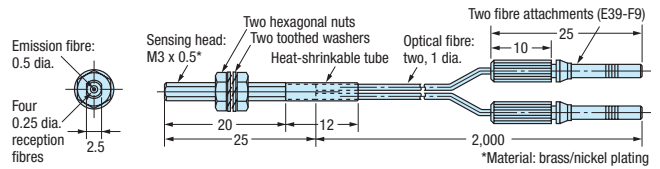

E32-EC41

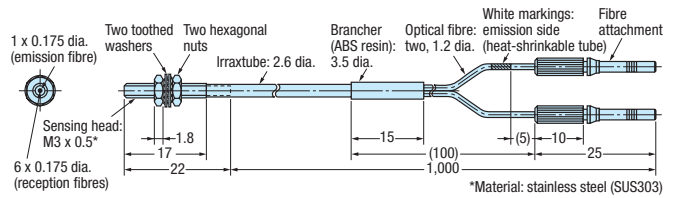

E32-ED11R

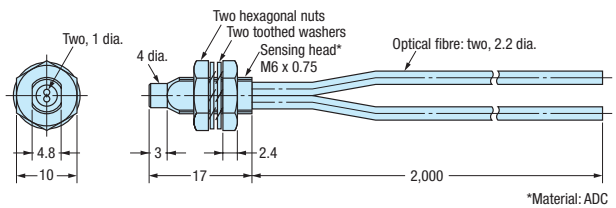

E32-ED21R

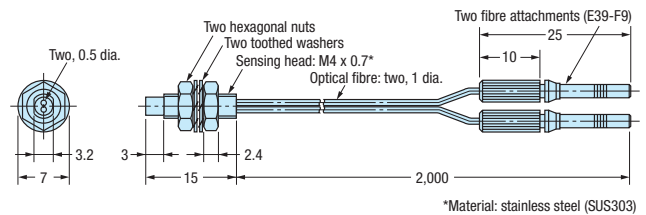

E32-ED51

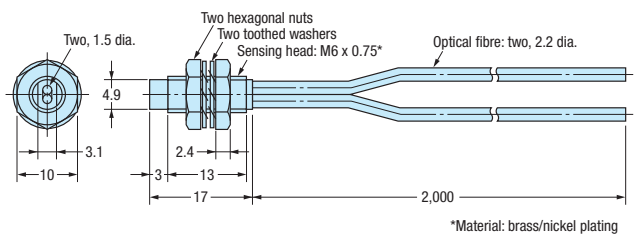

Product dimensions

E32-EDS24R

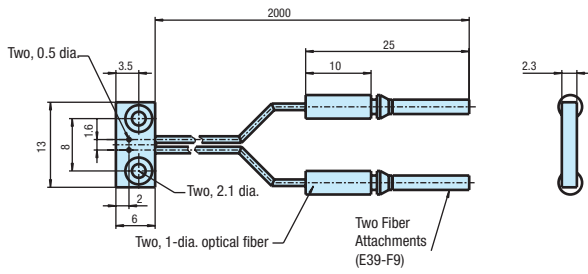

E32-EL24-1

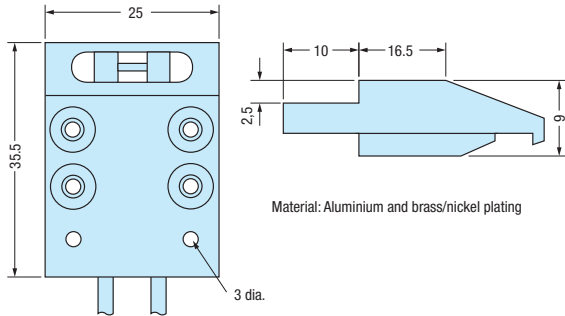

E32-ET11R

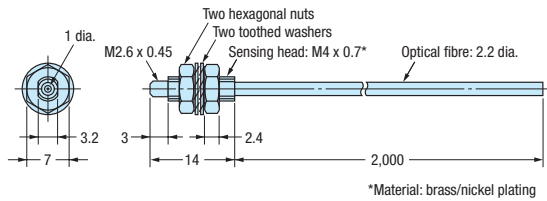

E32-ET16WR-1

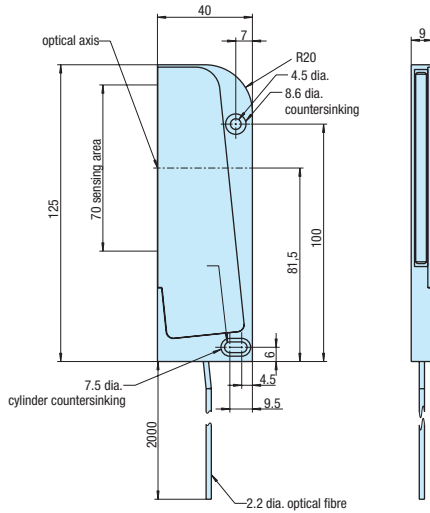

E32-ET16WR-2

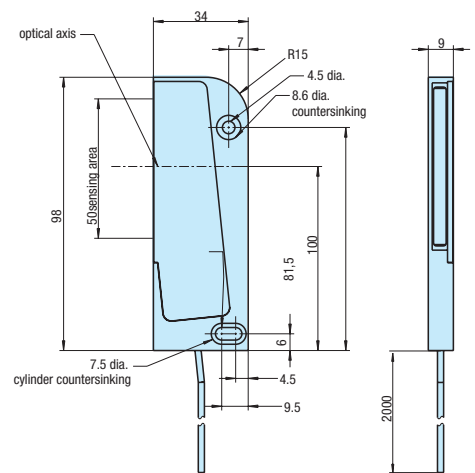

E32-ET21R

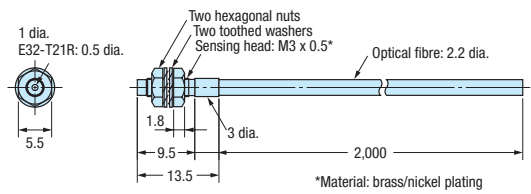

E32-ET51

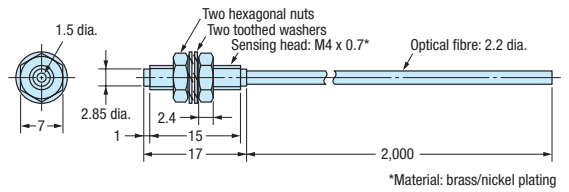

E32-ETS10R

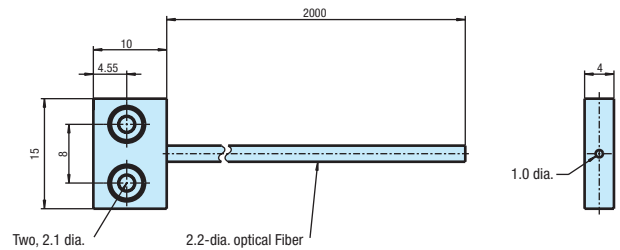

E32-ETS14R

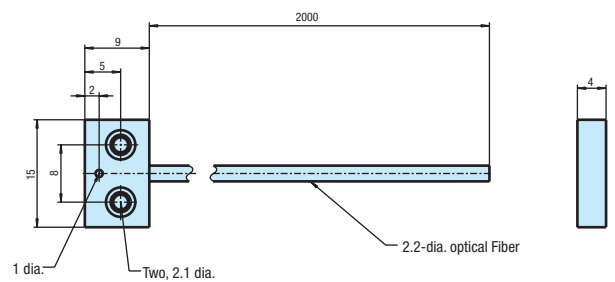

Product dimensions

E32-G14

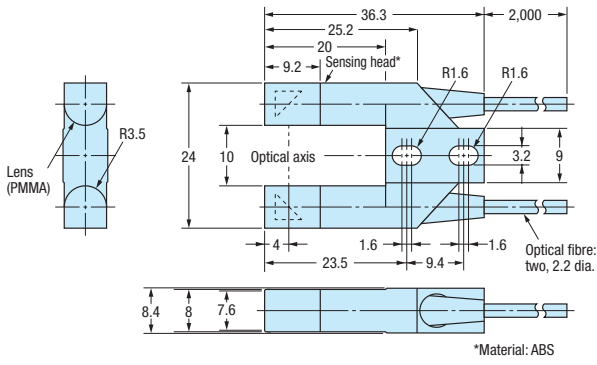

E32-L66

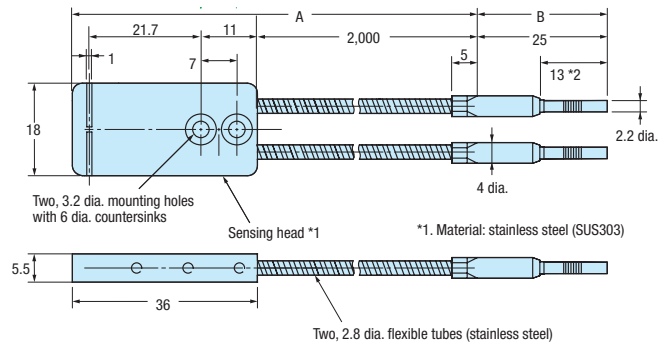

E32-L16

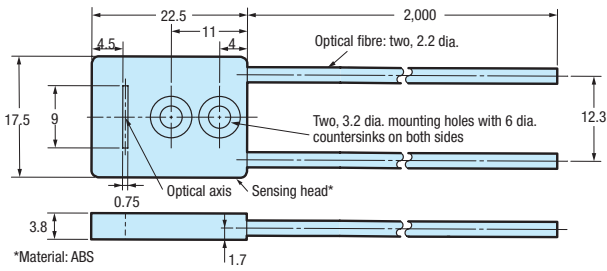

E32-M21

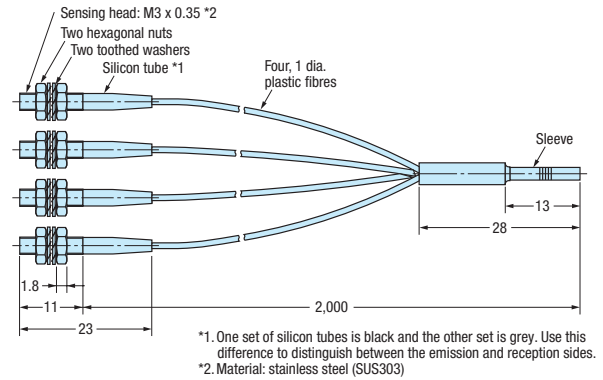

E32-L24L

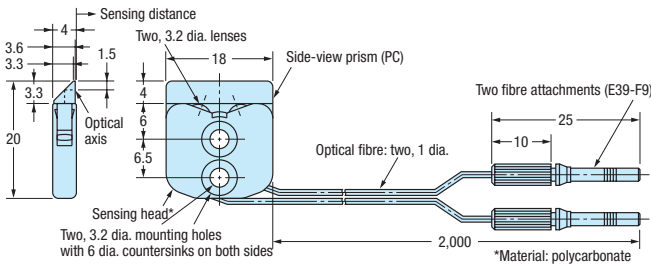

E32-L25

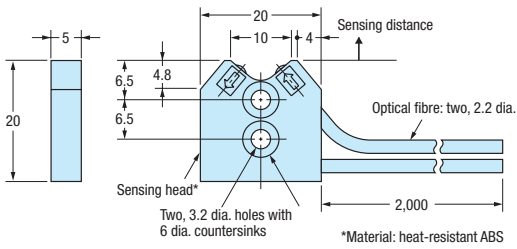

E32-L25L

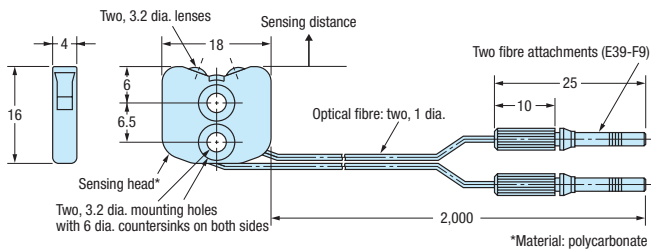

E32-R16

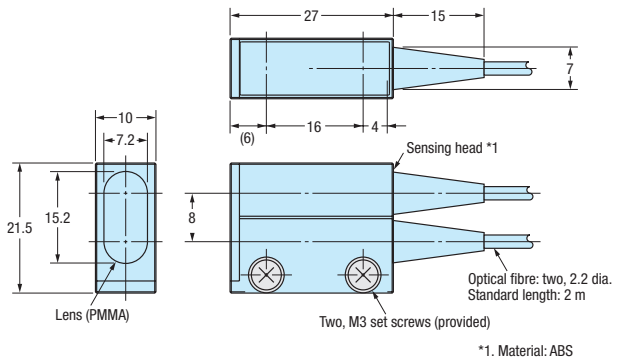

E32-R21

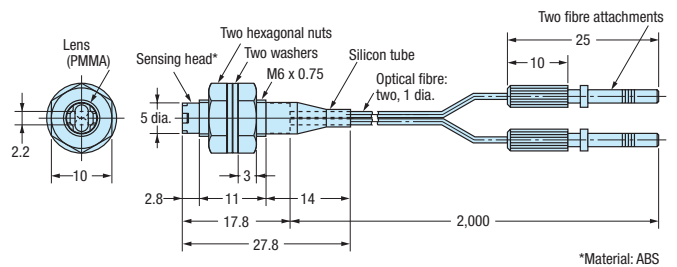

E32-T11, E32-T11U

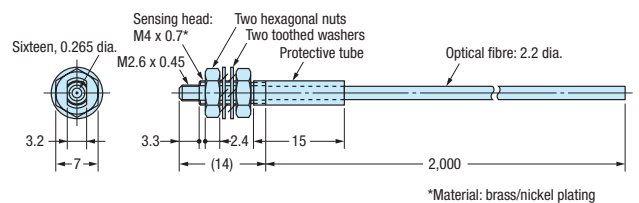

Product dimensions

E32-T11L

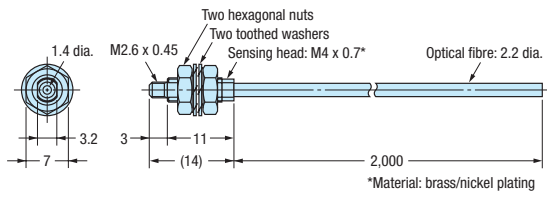

E32-T11N

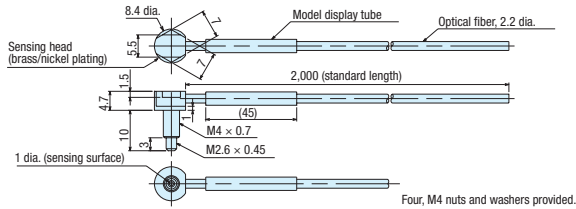

E32-T12, E32-T12R

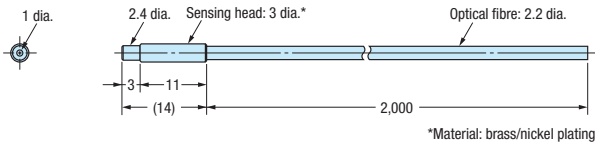

E32-T12B

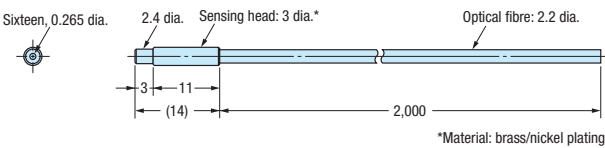

E32-T12F

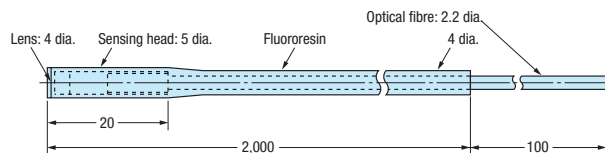

E32-T12L

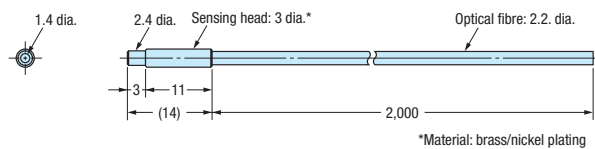

E32-T14

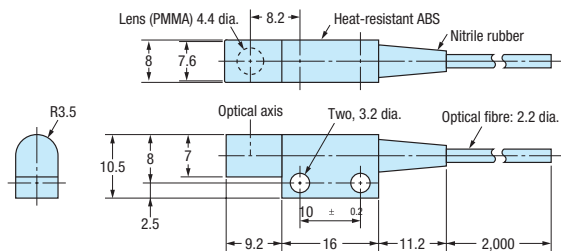

E32-T14F

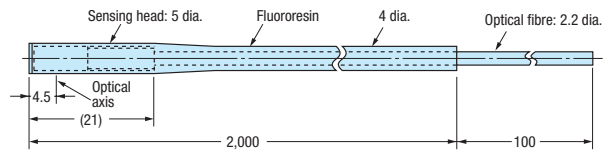

E32-T14L, E32-T14LR

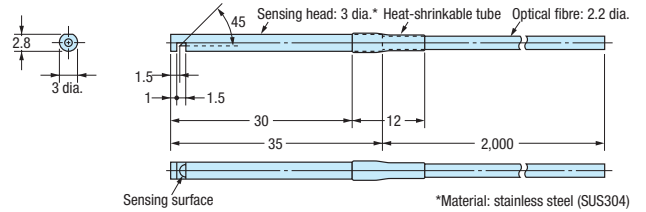

E32-T15X

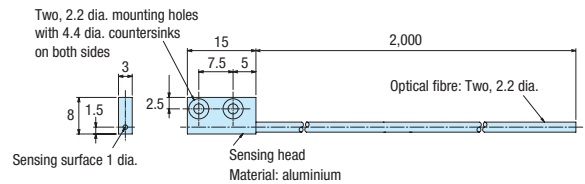

E32-T15XB

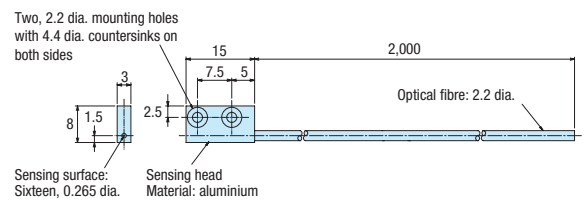

E32-T15Y, E32-T15YR

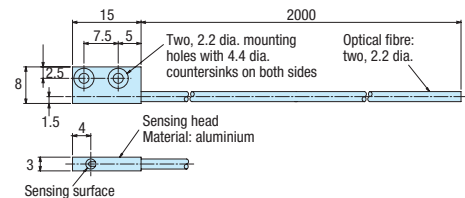

E32-T15Z

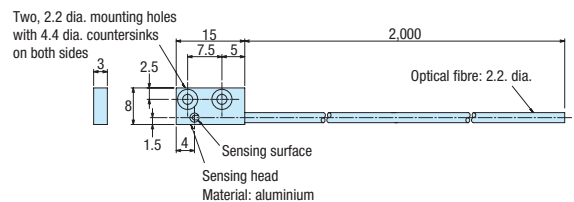

Product dimensions

E32-T16

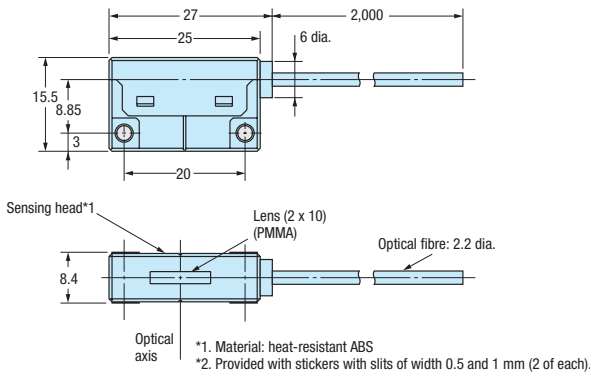

E32-T16J, E32-T16JR

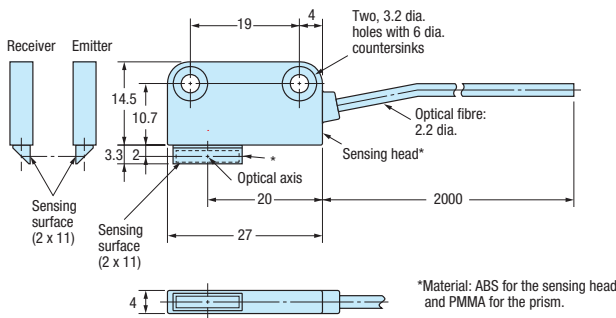

E32-T16P, E32-T16PR

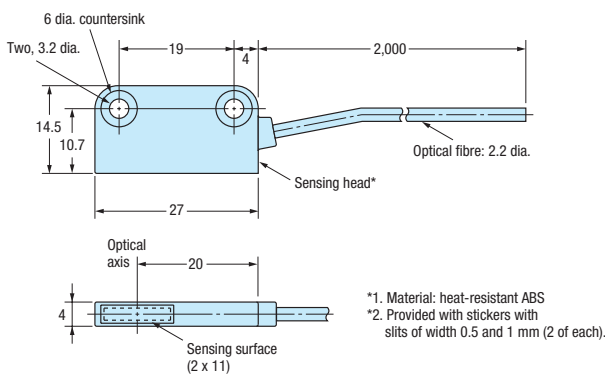

E32-T16W, E32-T16WR

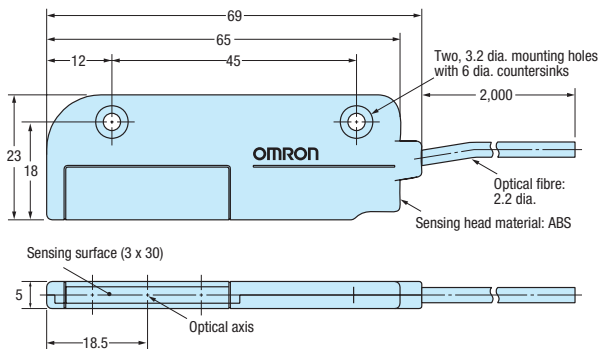

E32-T17L

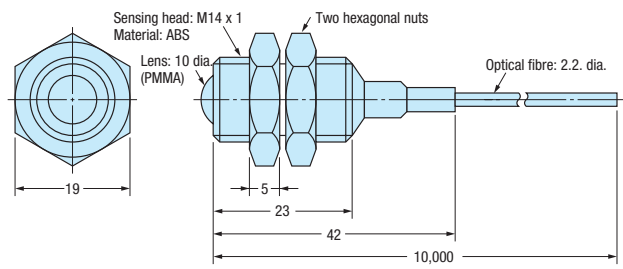

E32-T21

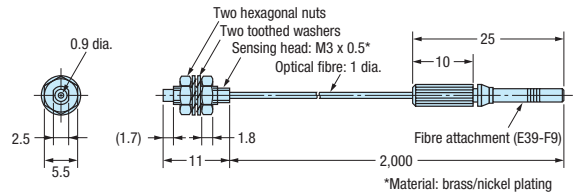

E32-T22, E32-T22R

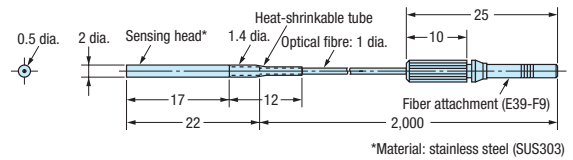

E32-T22B

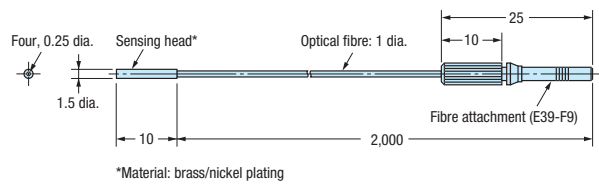

E32-T22L

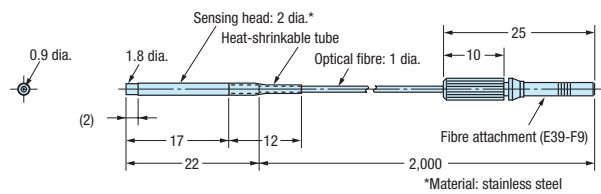

E32-T22S

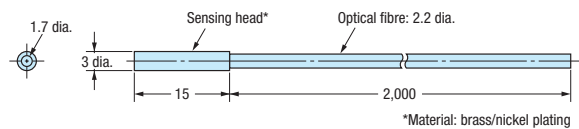

E32-T24, E32-T24R

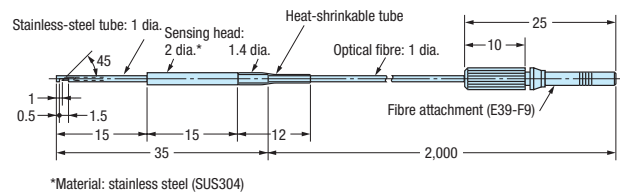

Product dimensions

E32-T24S

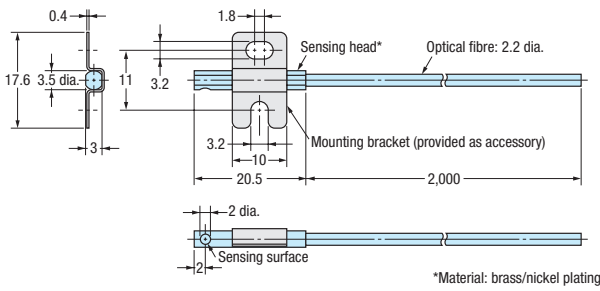

E32-T81R-S

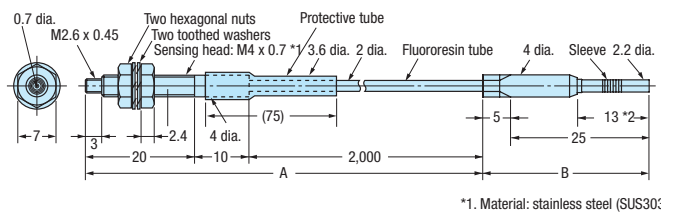

*1. Material: stainless steel (SUS303)

E32-T51F

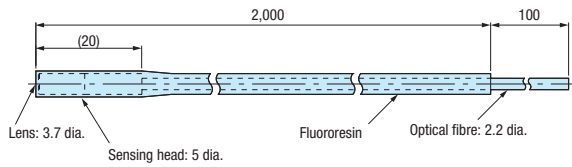

E32-T84S-S

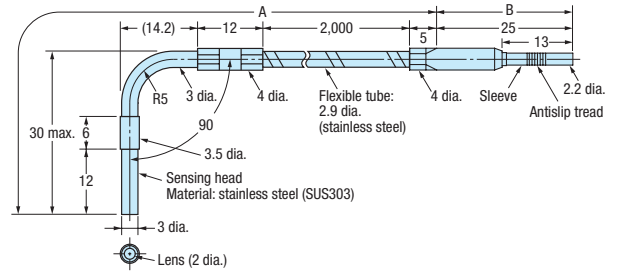

E32-T51V

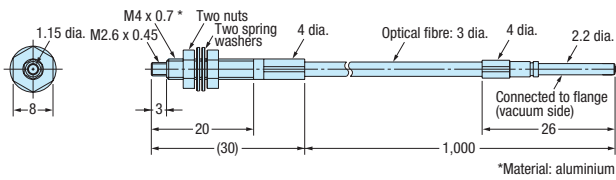

E32-T84SV

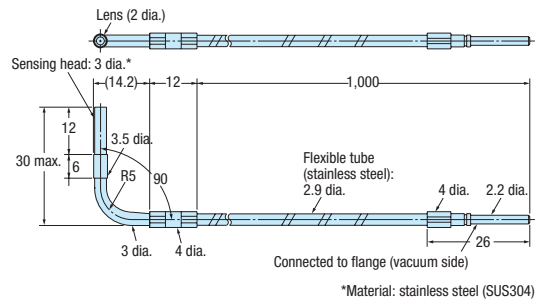

E32-T54

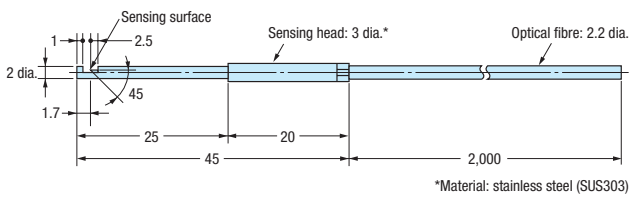

E32-T221B

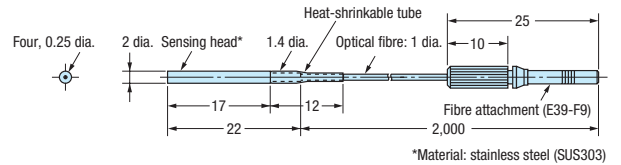

E32-T54V

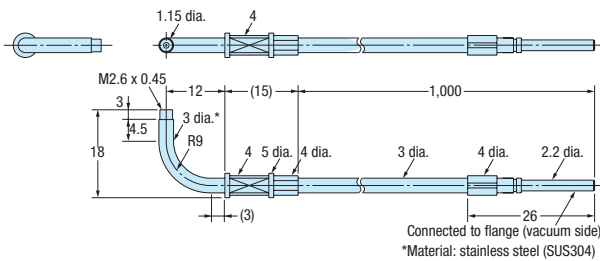

E32-T222, E32-T222R

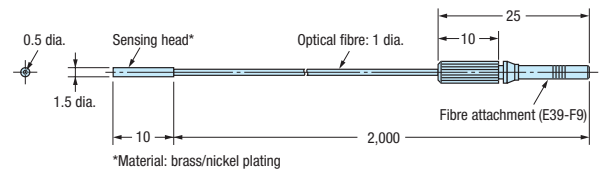

E32-T61-S

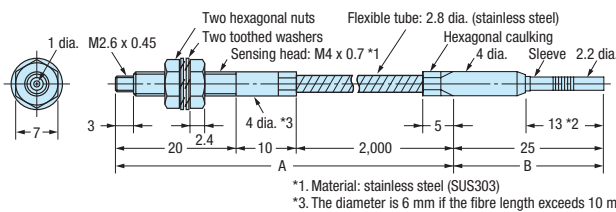

*1. Material: stainless steel (SUS303)
*3. The diameter is 6 mm if the fibre length exceeds 10 m.

E32-T223R

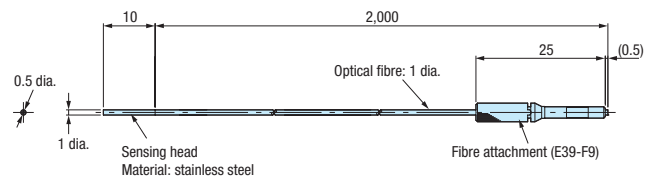

E32-T81F-S

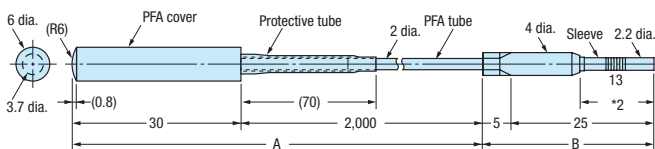

Product dimensions

E32-TC200

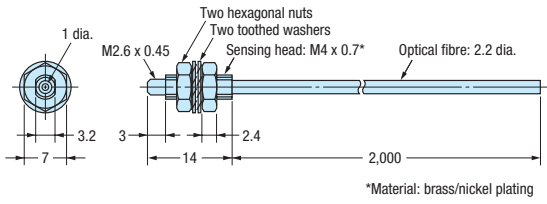

E32-TC200A

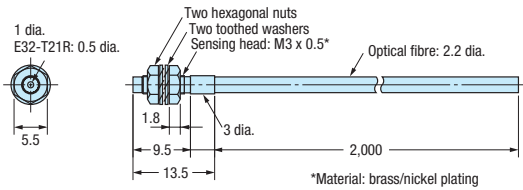

E32-TC200B, E32-TC200BR

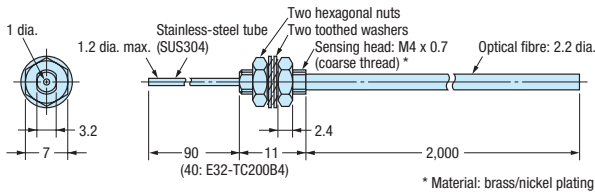

E32-TC200E

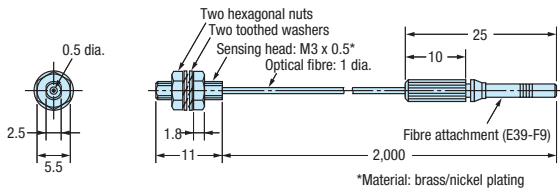

E32-TC200F, E32-TC200FR

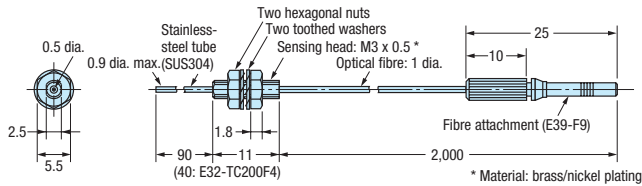

E39-EF1-37

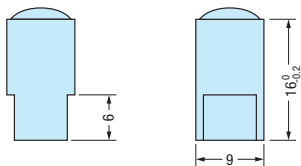

E39-EF51

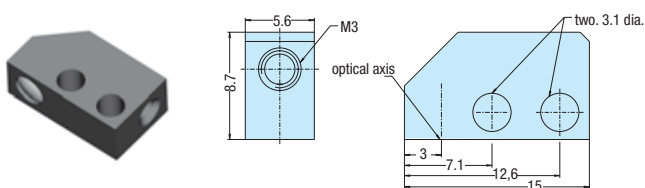

E39-F1

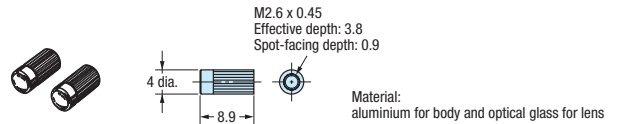

E39-F1V

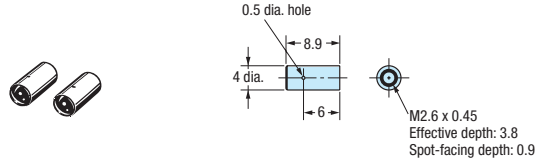

E39-F2

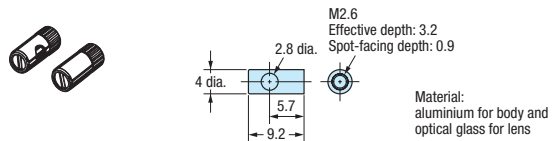

E39-F3A

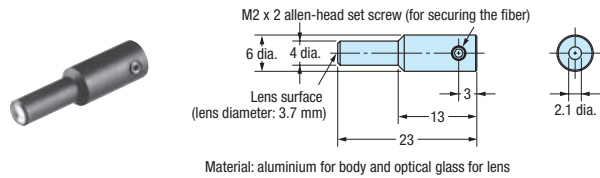

E39-F3A-5

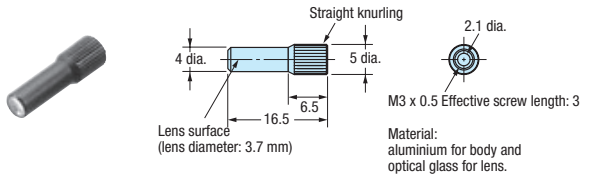

E39-F3B

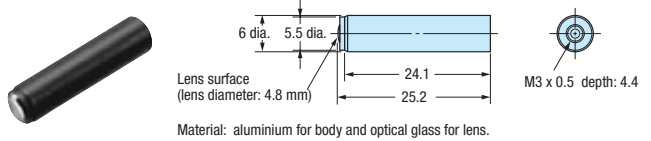

E39-F4

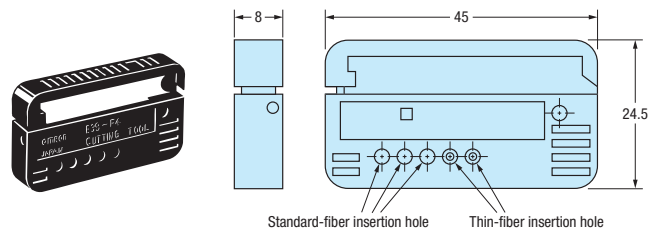

E39-F9

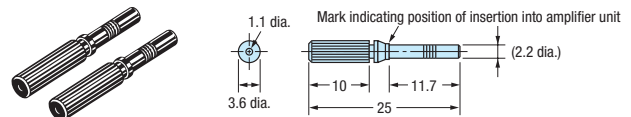

Product dimensions

E39-F10

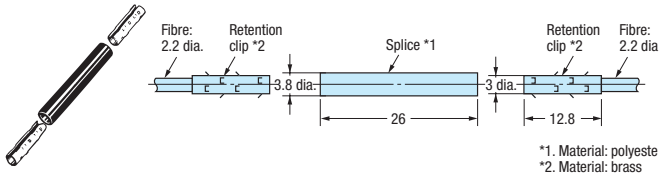

E39-F11

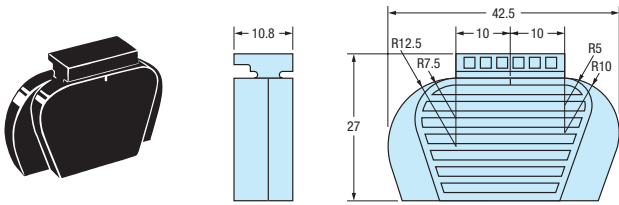

E39-F13, E39-F14, E39-F15

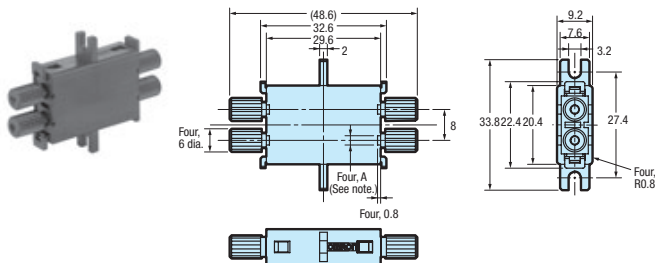

E39-F32A, E39-F32B

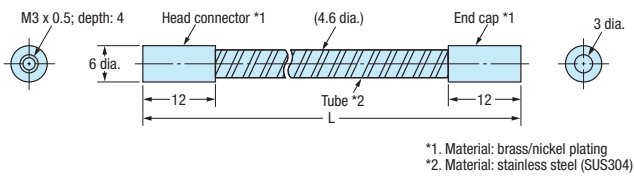

E39-F32C

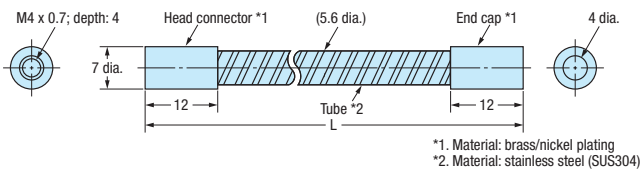

E39-F32D

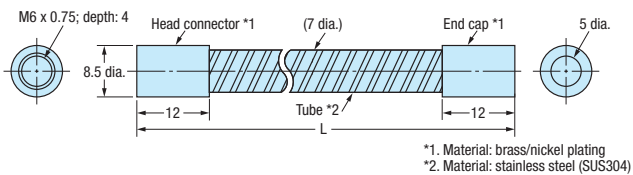

E39-R1S

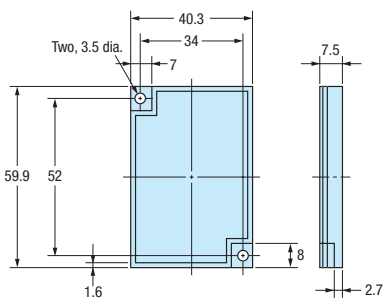

E39-R3

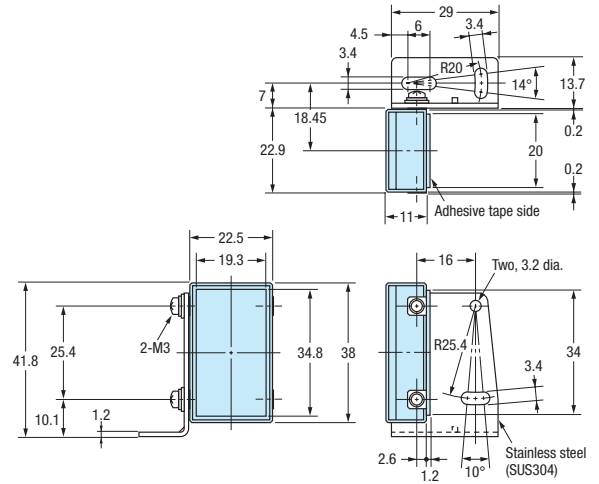

Product dimensions

Amplifier

E3X-DA_ amplifiers (teachable) - exemplary drawing for connector version

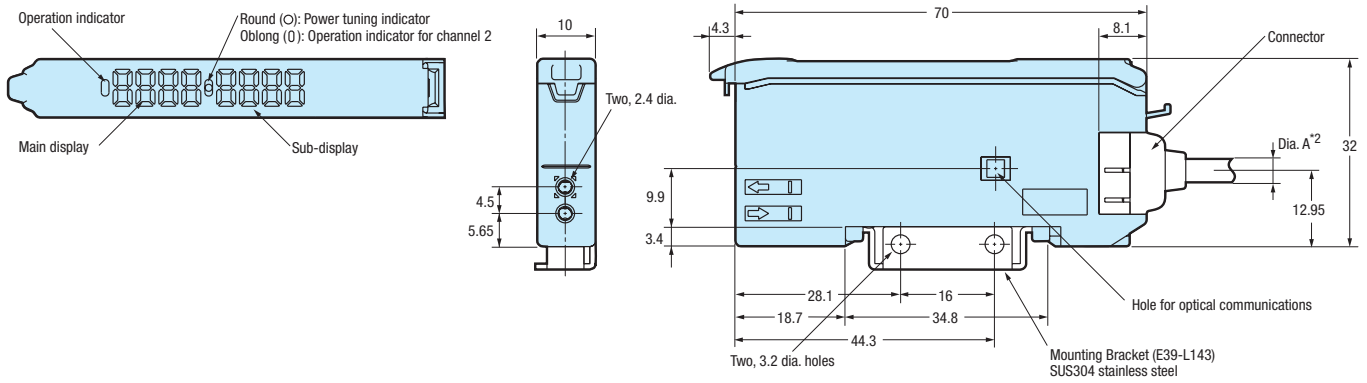

E3X-NA amplifiers (manual adjuster) - exemplary drawing for M8 connector version

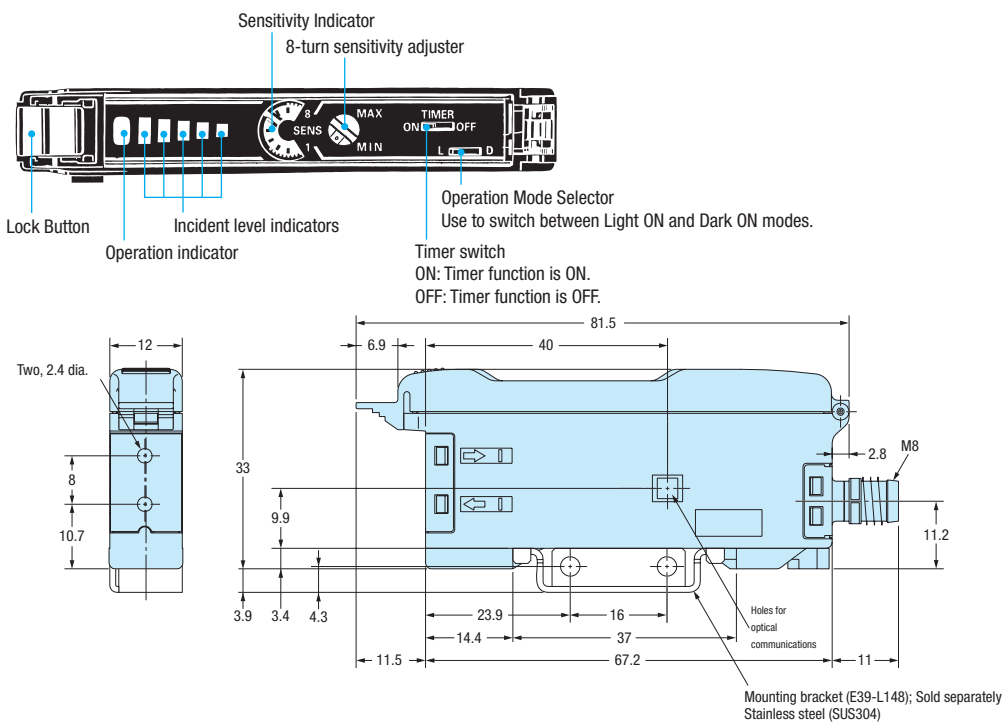

Product list

Order code	Group	Order code	Group	Order code	Group
E32-A03 2M	Precision detection	E32-ED11R 2M	Standard cylindrical	E32-T84SV 1M	Vacuum resistant
	Special application	E32-ED21R 2M	Standard cylindrical	E32-T221B	Robot applications
E32-A03-1 2M	Square shape	E32-ED51 2M	Heat resistant	E32-T222 2M	Miniature
E32-A04 2M	Miniature	E32-EDS24R 2M	Square shape	E32-T222R 2M	Miniature
	Precision detection	E32-EL24-1 2M	Precision detection	E32-T223R 2M	Miniature
	Special application	E32-ET11R 2M	Standard cylindrical	E32-TC200 2M	Standard cylindrical
E32-A04-1 2M	Square shape		Special application	E32-TC200A 2M	Longer distance
E32-A09 2M	Precision detection	E32-ET16WR-1 2M	Area monitoring	E32-TC200B	Miniature
	Special application	E32-ET16WR-2 2M	Area monitoring	E32-TC200BR	Miniature
E32-A09H 2M	Heat resistant	E32-ET21R 2M	Standard cylindrical	E32-TC200E 2M	Standard cylindrical
E32-A09H2 2M	Heat resistant	E32-ET51 2M	Heat resistant	E32-TC200F	Miniature
E32-C11N 2M	Precision detection	E32-ETS10R 2M	Square shape	E32-TC200FR	Miniature
E32-C31N 2M	Precision detection	E32-ETS14R 2M	Square shape	E39-EF1-37	Accessories
E32-C42 1M	Precision detection	E32-G14	Special application	E39-EF51	Accessories
E32-CC200 2M	Precision detection	E32-L16 2M	Precision detection	E39-F1	Accessories
	Special application	E32-L24L	Precision detection	E39-F10	Accessories
E32-D11 2M	Robot applications		Special application	E39-F11	Accessories
E32-D11L 2M	Longer distance	E32-L25	Precision detection	E39-F13	Accessories
E32-D11N 2M	Standard cylindrical	E32-L25L	Precision detection	E39-F14	Accessories
E32-D11U 2M	Chemical resistant		Special application	E39-F15	Accessories
E32-D12 2M	Longer distance	E32-L66 2M	Special application	E39-F1V	Accessories
E32-D12F	Chemical resistant	E32-M21	Area monitoring	E39-F2	Accessories
E32-D14F 2M	Chemical resistant	E32-R16 2M	Longer distance	E39-F32A	Accessories
E32-D14L 2M	Standard cylindrical	E32-R21	Standard cylindrical	E39-F32B	Accessories
E32-D14LR 2M	Standard cylindrical	E32-T11 2M	Robot applications	E39-F32C	Accessories
E32-D15X 2M	Square shape	E32-T11 2M	Longer distance	E39-F32D	Accessories
E32-D15XB 2M	Robot applications	E32-T11N 2M	Standard cylindrical	E39-F3A	Accessories
E32-D15XR 2M	Square shape	E32-T11U 2M	Chemical resistant	E39-F3A-5	Accessories
E32-D15Y 2M	Square shape	E32-T12 2M	Miniature	E39-F3B	Accessories
E32-D15YR 2M	Square shape	E32-T12 2M	Robot applications	E39-F4	Accessories
E32-D15Z 2M	Square shape	E32-T12B	Robot applications	E39-F9	Accessories
E32-D16 2M	Longer distance	E32-T12F	Chemical resistant	E39-R1S	Accessories
E32-D21 2M	Robot applications	E32-T12L 2M	Longer distance	E39-R3	Accessories
E32-D21B 2M	Robot applications	E32-T12R 2M	Miniature	E3X-CN21	Accessories
E32-D21L 2M	Longer distance	E32-T14 2M	Longer distance	E3X-CN21-M1J	Accessories
E32-D22 2M	Miniature	E32-T14F 2M	Chemical resistant	E3X-CN21-M3J-2	Accessories
E32-D22B 2M	Miniature	E32-T14L 2M	Miniature	E3X-DA_AT-S	Advanced amplifiers
	Robot applications	E32-T14LR 2M	Miniature	E3X-DA_-S	Advanced amplifiers
E32-D22R 2M	Miniature	E32-T15X 2M	Square shape	E3X-DA_SE-S	Easy usage amplifiers
E32-D24	Miniature	E32-T15XB 2M	Robot applications	E3X-DAC_-S	Advanced amplifiers
E32-D24R 2M	Miniature	E32-T15Y 2M	Square shape	E3X-MDA_	Advanced amplifiers
E32-D32 2M	Miniature	E32-T15YR 2M	Square shape	E3X-NA	Easy usage amplifiers
	Precision detection	E32-T15Z 2M	Square shape	E3X-NA_F	Advanced amplifiers
E32-D32L 2M	Precision detection	E32-T16	Area monitoring	E3X-SD	Easy usage amplifiers
E32-D32R 2M	Miniature	E32-T16J 2M	Area monitoring		
E32-D33 2M	Miniature	E32-T16JR 2M	Area monitoring		
E32-D36P1 2M	Area monitoring	E32-T16P	Area monitoring		
E32-D36T 2M	Special application	E32-T16PR 2M	Area monitoring		
E32-D61/ D61-S 2M	Heat resistant	E32-T16W 2M	Area monitoring		
E32-D73/ D73-S 2M	Heat resistant	E32-T16WR 2M	Area monitoring		
E32-D81R/ D81R-S 2M	Heat resistant	E32-T17L	Longer distance		
E32-D82F1 4M	Special application	E32-T21 2M	Robot applications		
E32-D211 2M	Standard cylindrical	E32-T22 2M	Miniature		
E32-D211R 2M	Standard cylindrical	E32-T22B	Robot applications		
E32-D331 2M	Miniature	E32-T22L 2M	Longer distance		
E32-DC200 2M	Standard cylindrical	E32-T22R 2M	Miniature		
E32-DC200B 2M	Miniature	E32-T22S	Precision detection		
E32-DC200BR	Miniature		Special application		
E32-DC200E 2M	Standard cylindrical	E32-T24	Miniature		
E32-DC200F	Miniature	E32-T24R 2M	Miniature		
E32-DC200FR	Miniature	E32-T24S	Special application		
E32-E01 100M	Accessories	E32-T51F 2M	Chemical resistant		
E32-E01R 100M	Accessories	E32-T51V 1M	Vacuum resistant		
E32-E02 100M	Accessories	E32-T54 2M	Heat resistant		
E32-E02R 100M	Accessories	E32-T54V 1M	Vacuum resistant		
E32-E05 100M	Accessories	E32-T61-S 2M	Heat resistant		
E32-EC31 2M	Precision detection	E32-T81F-S 2M	Chemical resistant		
	Special application	E32-T81R-S 2M	Heat resistant		
E32-EC41 1M	Precision detection	E32-T84S-S 2M	Heat resistant		

Precautions

Fiber Units

Installation

Tightening Force

The tightening force applied to the Fiber Unit should be as follows:

Screw-mounting Model Cylindrical Model

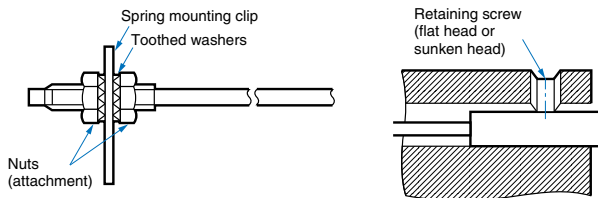

Fiber Units	Clamping torque
M3/M4 screw	0.78 Nm max.
M6 screw/6-mm dia. column	0.98 Nm max.
1.5-mm dia. column	0.2 Nm max.
2-mm dia./3-mm dia. column	0.29 Nm max.
E32-T12F 5-mm dia. Teflon model	0.78 Nm max.
E32-D12F 6-mm dia. Teflon model	
E32-T16	0.49 Nm max.
E32-R21	0.59 Nm max.
E32-M21	0.49 Nm max. for up to 5 mm from front end, 0.78 Nm max. for more than 5 mm from front end
E32-T16P E32-T16PR E32-T24S E32-L24L E32-L25L E32-T16J E32-T16JR	0.29 Nm max.
E32-ET16W E32-ET16WR	0.3 Nm max.

Use a proper-sized wrench.

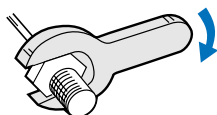

Cutting Fiber

- Insert a fiber into the Fiber Cutter and determine the length of the fiber to be cut.
- Press down the Fiber Cutter in a single stroke to cut the fiber.
- Cut a thin fiber as follows:

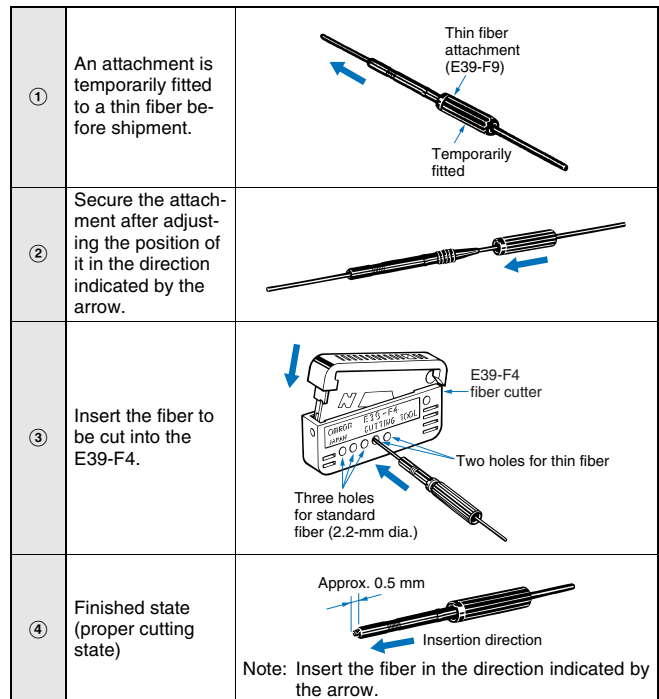

Connection

- Do not pull or press the fiber units. The fiber units withstand tensile or compression force of 9.8 N or 29.4 N maximum.
- Do not bend the fiber unit beyond the permissible bending radius given under Ordering Information.
- Do not bend the edge of the fiber units (excluding the E32-T□R and E32-D□R).

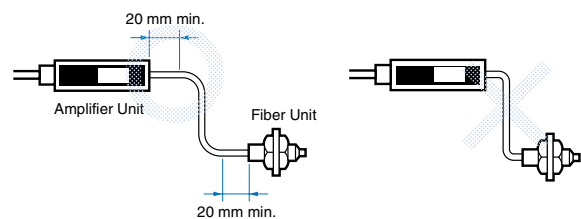

- Do not apply excess force on the fiber units.



- The fiber head may break due to excessive vibration. A one turn loop may reduce the effect of vibrations:

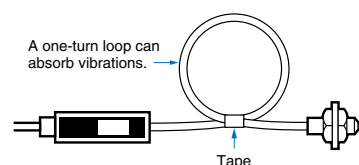

E39-F11 Sleeve Bender

- The bending radius of the stainless steel tube should be as large as possible. The smaller the bending radius becomes, the shorter the sensing distance will be.
- Insert the tip of the stainless steel tube to the sleeve bender and bend the stainless steel tube slowly along the curve of the sleeve bender (refer to the figure).

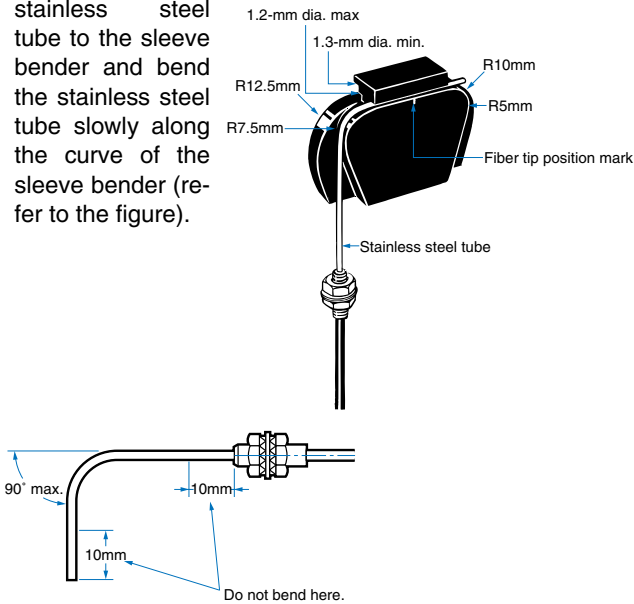

Heat-resistant fibers

- The fiber connector E39-F10 cannot be used for extension.

E32-T14/E32-G14

The presence of a reflective object at the front ends of the lenses may place the unit in an incident state. In this case, apply the supplied black stickers to the front ends of the lenses.

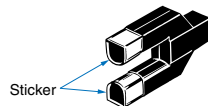

Supplied slit for E32-T16

When using the supplied slit, peel off the back paper and apply it along the outline of the sensing surface. The slit is recommended in applications where saturation occurs.

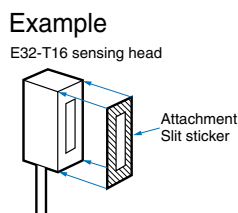

E32-M21

To prevent mutual interference sufficient distance between the four sensing heads has to be ensured.

Adjustment

E32-G14

Due to the short distance between the sensor heads, two-point teaching (with and without object) is recommended.

Accessories

Protective Spiral Tubes

1. Insert a fiber to the protective spiral tube from the head connector side (screwed) of the tube.

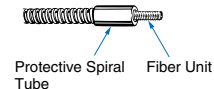

2. Push the fiber into the protective spiral tube. The tube should be straight so that the fiber is not twisted when inserted. Then turn the end cap of the spiral tube.

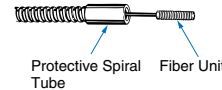

3. Secure the protective spiral tube at a suitable place with the attached nut.

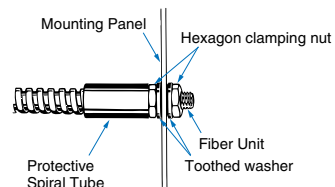

4. Use the attached saddle to secure the end cap of the protective spiral tube. To secure the protective spiral tube at a position other than the end cap, apply tape to the tube so that the portion becomes thicker in diameter.

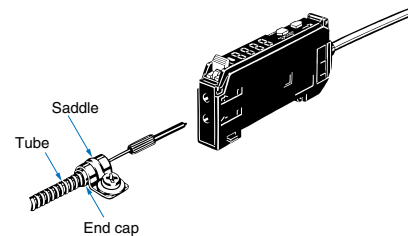

E39-F10 Fiber Connector

Fit the connector in the following procedure.

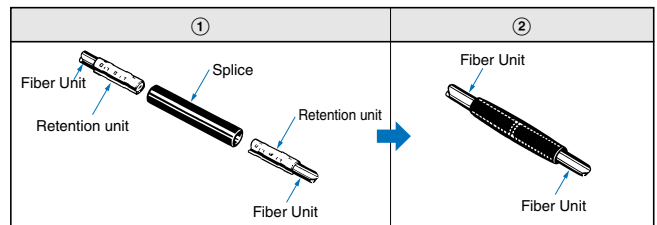

- The fiber units should be as close as possible when they are connected. Sensing distance will be reduced by approximately 25% when fibers are connected.

Only 2.2 mm dia. fibers can be connected.

Amplifier Unit

Installation

- Operation after Turning Power ON

The Amplifier Unit is ready to operate within 200 ms after the power supply is turned ON. If the Sensor and load are connected to power supplies separately, be sure to turn ON the power supply to the Sensor first.

Mounting

- Connecting and Disconnecting Connectors

Mounting Connectors

1. Insert the Master or Slave Connector into the Amplifier Unit until it clicks into place.

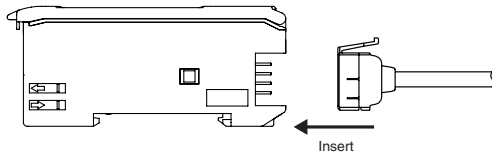

2. Attach the protector seals (provided as accessories) to the sides of master and slave connectors that are not connected.

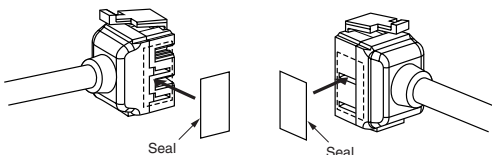

Note: Attach the seals to the sides with grooves

Removing Connectors

1. Slide the slave Amplifier Unit(s) for which the Connector is to be removed away from the rest of the group.
2. After the Amplifier Unit(s) has been separated, press down on the lever on the Connector and remove it. (Do not attempt to remove Connectors without separating them from other Amplifier Units first.)

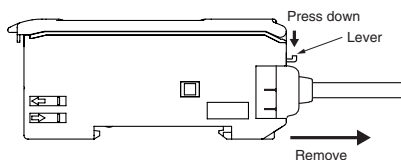

- Joining and Removing Amplifier Units

Joining Amplifier Units

1. Mount the Amplifier Units one at a time onto the DIN track.

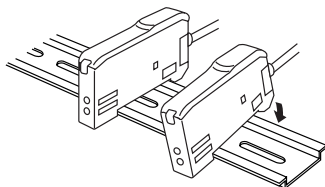

2. Slide the Amplifier Units together, line up the clips, and press the Amplifier Units together until they click into place.

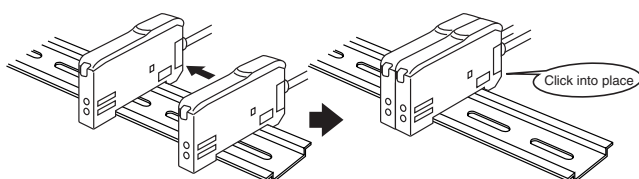

Separating Amplifier Units

Slide Amplifier Units away from each other, and remove from the DIN track one at a time. (Do not attempt to remove Amplifier Units from the DIN track without separating them first.)

Note 1. The specifications for ambient temperature will vary according to the number of Amplifier Units used together. For details, refer to *Ratings/Characteristics*.

2. Always turn OFF the power supply before joining or separating Amplifier Units.

- Mounting the End Plate (PFP-M)

An End Plate should be used if there is a possibility of the Amplifier Unit moving, e.g., due to vibration. If a Mobile Console is going to be mounted, connect the End Plate in the direction shown in the following diagram.

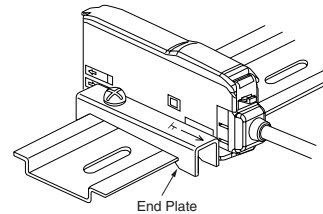

- Mounting the Mobile Console Head

Leave a gap of at least 20 mm between the nearest Amplifier Unit and the Mobile Console head.

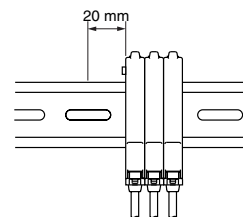

• Fiber Connection

The E3X Amplifier Unit has a lock button for easy connection of the Fiber Unit. Connect or disconnect the fibers using the following procedures:

1. Connection

Open the protective cover, insert the fibers according to the fiber insertion marks on the side of the Amplifier Unit, and lower the lock button.

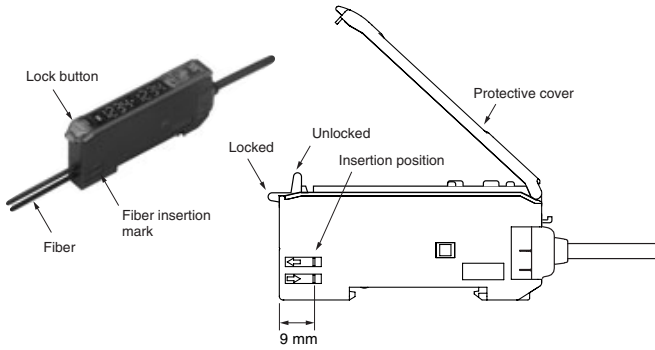

Fibers with E39-F9 Attachment

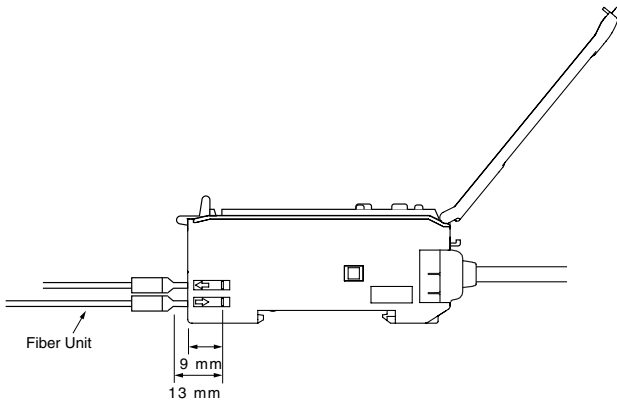

Fibers That Cannot Be Free-Cut (with Sleeves)

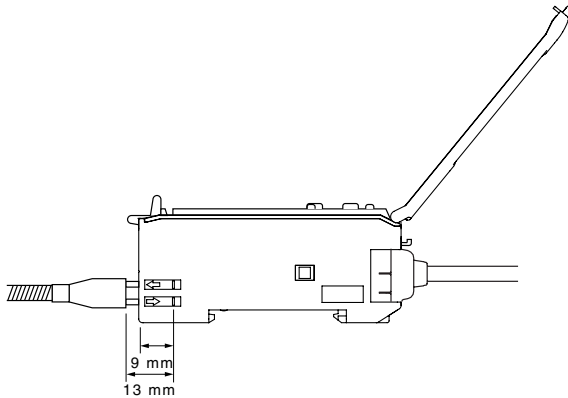

Note: For complete precautions and installation instructions refer to individual amplifier datasheets.

2. Disconnecting Fibers

Remove the protective cover and raise the lock button to pull out the fibers.

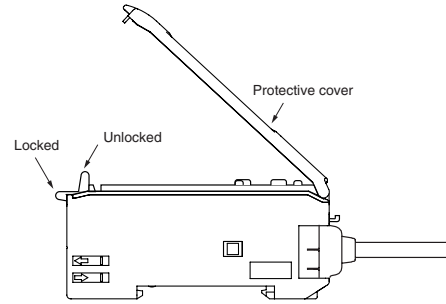

Note 1. To maintain the fiber properties, confirm that the lock is released before removing the fibers.

2. Be sure to lock or unlock the lock button within an ambient temperature range between -10°C and 40°C .

• Protective Cover

Always keep the protective cover in place when using the Amplifier Unit.

Cat. No. E56E-EN-01A

In the interest of product improvement, specifications are subject to change without notice.

OMRON EUROPE B.V.

Wegalaan 67-69,
NL-2132 JD, Hoofddorp,
The Netherlands
Phone: +31 23 568 13 00
Fax: +31 23 568 13 88
www.industrial.omron.eu

Below is a list of articles with direct links to our shop Electric Automation Network where you can see:

- Quote per purchase volume in real time.
- Online documentation and datasheets of all products.
- Estimated delivery time enquiry in real time.
- Logistics systems for the shipment of materials almost anywhere in the world.
- Purchasing management, order record and tracking of shipments.

To access the product, [click on the green button.](#)

Product	Code	Reference	Product link
	119179		Buy on EAN
	132581		Buy on EAN
JX Inverter drive, 0.4kW, 1.5A, 400VAC, 3-phase	263789		Buy on EAN
	151955		Buy on EAN