



**Electric Automation**  
Automation specialists

Reference: RTM 120 FS  
Code: 6042012

T-branch piece with quick connector,  
110x200, Strip-galvanised, DIN EN  
10147, Steel, St

Buy it at [Electric Automation Network](#)

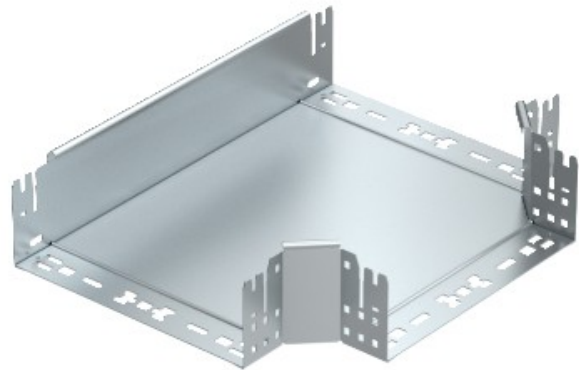

T branch piece with quick connector system. For all cable tray types of 110 mm side height.