



Electric Automation
Automation specialists

Reference: RTM 110 FS
Code: 6042010

T-branch piece with quick connector,
110x100, Strip-galvanised, DIN EN
10147, Steel, St

Buy it at [Electric Automation Network](#)

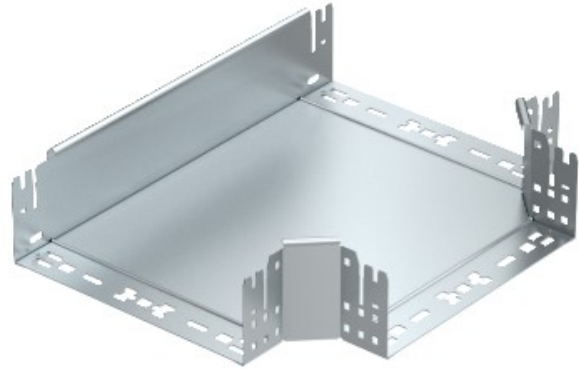

T branch piece with quick connector system. For all cable tray types of 110 mm side height.