



**Electric Automation**  
Automation specialists

Reference: RBM 90 110 FT  
Code: 6041860

90° bend with quick connector,  
110x100, Hot-dip galvanised, DIN EN ISO  
1461, Steel, St

Buy it at [Electric Automation Network](#)

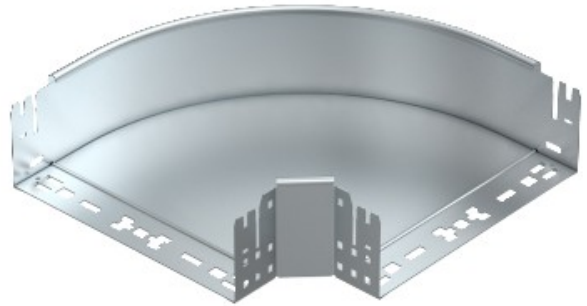

90° bend with quick connector system. For all cable tray types of 110 mm side height.