



Electric Automation
Automation specialists

Reference: RBM 90 160 FS
Code: 6041850

90° bend with quick connector,
110x600, Strip-galvanised, DIN EN
10147, Steel, St

Buy it at [Electric Automation Network](#)

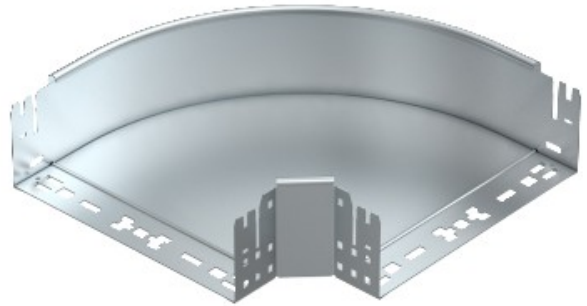

90° bend with quick connector system. For all cable tray types of 110 mm side height.